

US00D528669S

(12) **United States Design Patent** (10) **Patent No.:** **US D528,669 S**
Zarb (45) **Date of Patent:** **** Sep. 19, 2006**

(54) **TRIM SYSTEMS COMPONENT FOR BUILDING STRUCTURES**

(75) Inventor: **Joseph Emmanuel Zarb**, Bonnyrigg Heights (AU)

(73) Assignee: **James Hardie International Finance B.V.**, Amsterdam (NL)

(**) Term: **14 Years**

(21) Appl. No.: **29/219,601**

(22) Filed: **Dec. 17, 2004**

(30) **Foreign Application Priority Data**

Jun. 17, 2004 (AU) 13009/2004

(51) **LOC (8) Cl.** **25-01**

(52) **U.S. Cl.** **D25/136**

(58) **Field of Classification Search** D25/119, D25/61, 136; 52/716.1, 290, 287.1, 288.1
See application file for complete search history.

(56) **References Cited**

U.S. PATENT DOCUMENTS

| | | | | |
|-----------|---|-----------|--------------------|----------|
| 4,876,827 | A | 10/1989 | Williams | |
| 4,969,250 | A | 11/1990 | Hickman et al. | |
| 5,067,675 | A | 11/1991 | Brant | |
| D322,678 | S | * 12/1991 | Brathwaite | D25/136 |
| 5,297,370 | A | * 3/1994 | Greenstreet et al. | 52/287.1 |
| D388,884 | S | * 1/1998 | Karnoski | D25/102 |
| 5,802,790 | A | * 9/1998 | Lamont et al. | 52/288.1 |
| D489,137 | S | * 4/2004 | Eichner et al. | D25/119 |
| D489,463 | S | * 5/2004 | Barnett | D25/119 |
| D492,424 | S | * 6/2004 | Barnett | D25/119 |

FOREIGN PATENT DOCUMENTS

| | | | |
|----|-----------|----|---------|
| AU | 198288589 | A1 | 3/1983 |
| AU | 94035 | S | 11/1986 |
| AU | 95878 | S | 3/1987 |
| AU | 98800 | S | 12/1987 |
| AU | 99683 | S | 2/1988 |
| AU | 102662 | S | 1/1989 |
| AU | 103840 | S | 5/1989 |

| | | | |
|----|-----------|----|---------|
| AU | 104552 | S | 8/1989 |
| AU | 108078 | S | 7/1990 |
| AU | 110320 | S | 2/1991 |
| AU | B-7620-91 | | 6/1992 |
| AU | 117138 | S | 5/1993 |
| AU | 118448 | S | 10/1993 |
| AU | 118862 | S | 11/1993 |
| AU | 122634 | S | 2/1995 |
| AU | 123141 | S | 4/1995 |
| AU | 123142 | S | 4/1995 |
| AU | 199652126 | B2 | 11/1996 |
| AU | 130941 | S | 8/1997 |

(Continued)

OTHER PUBLICATIONS

Australian Search Report; dated Jul. 6, 2004; Application No. 2004903567.

International Search Report; dated Feb. 11, 2005; International Application No. PCT/AU2004/001672.

First Examination Report; dated Feb. 15, 2005; Australian Innovation Patent No. 2004101018.

Australian Patent and Design Infringement Search Results in respect of the pre-finished eave system Concept.

New Zealand Patent and Design Infringement search results in respect of the pre-finished eave system concept.

Primary Examiner—Doris Clark

(74) *Attorney, Agent, or Firm*—Gardere Wynne Sewell LLP

(57) **CLAIM**

The ornamental design for a trim systems component for building structures, as shown and described.

DESCRIPTION

FIG. 1 is a perspective view of the trim systems component for building structures of the present design;

FIG. 2 is a front end view thereof;

FIG. 3 is a rear end view thereof;

FIG. 4 is a right side view thereof;

FIG. 5 is a left side view thereof;

FIG. 6 is a top plan view thereof; and,

FIG. 7 is a bottom view thereof.

1 Claim, 2 Drawing Sheets

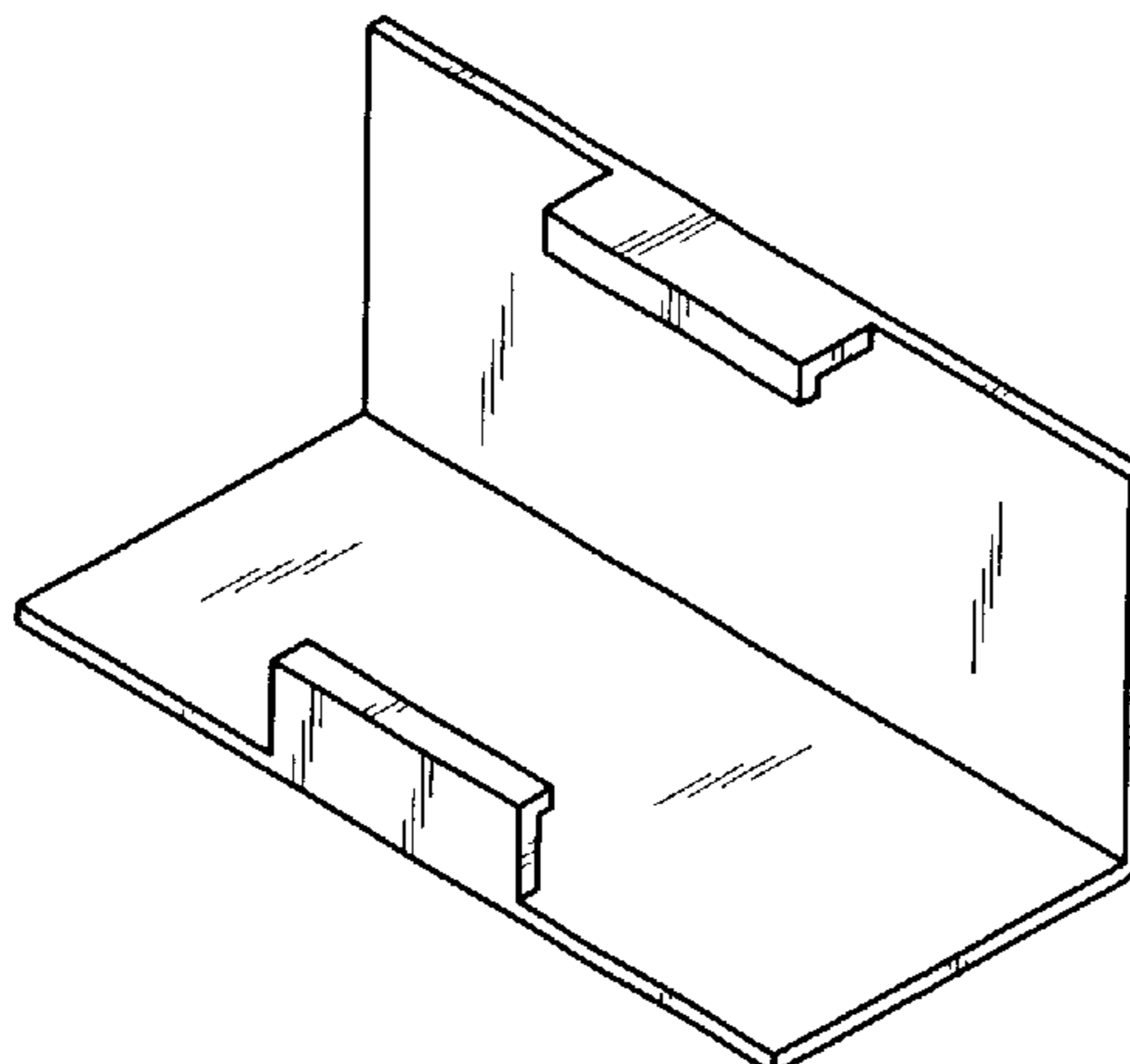

| FOREIGN PATENT DOCUMENTS | | | | | |
|--------------------------|---------------|---------|----|----------------|---------|
| | | | NZ | 211265 | 2/1985 |
| | | | NZ | 20119 | 10/1985 |
| AU | 132812 S | 2/1998 | NZ | 20120 | 10/1985 |
| AU | 135097 S | 9/1998 | NZ | 20844 | 11/1986 |
| AU | 13557 S | 11/1998 | NZ | 218315 | 2/1987 |
| AU | 137291 S | 5/1999 | NZ | 21875 | 4/1988 |
| AU | 137791 S | 7/1999 | NZ | 22705 | 7/1989 |
| AU | 140607 S | 5/2000 | NZ | 240533 | 11/1991 |
| AU | 147568 S | 4/2002 | NZ | 242960 | 5/1992 |
| AU | 148485 S | 7/2002 | NZ | 25267 | 9/1993 |
| AU | 2002301511 A1 | 6/2003 | NZ | 248942 | 10/1993 |
| AU | 152915 S | 8/2003 | NZ | 25838 | 4/1994 |
| AU | 153491 S | 10/2003 | NZ | 26065 | 7/1994 |
| AU | 153493 | 10/2003 | NZ | 26066 | 7/1994 |
| AU | 153494 S | 10/2003 | NZ | 306382 | 5/1996 |
| AU | 153495 S | 10/2003 | NZ | 504881 | 10/1998 |
| AU | 153496 S | 10/2003 | NZ | 334918 | 3/1999 |
| CA | 730345 A | 3/1966 | NZ | 331336 | 10/1999 |
| GB | 1125825 | 9/1968 | NZ | 512028 | 11/1999 |
| GB | 1 269 357 | 4/1972 | NZ | 602004 | 12/1999 |
| GB | 2 021 186 A | 11/1979 | NZ | 400643 | 4/2000 |
| GB | 2 075 079 A | 11/1981 | NZ | 505799 | 7/2000 |
| GB | 2 078 611 A | 1/1982 | NZ | 507846 | 10/2000 |
| GB | 2 199 857 A | 7/1988 | NZ | 508055 | 11/2000 |
| GB | 2 340 071 A | 2/2000 | NZ | 516912 | 1/2002 |
| JP | 08074377 A | 9/1994 | NZ | 517658 | 3/2002 |
| JP | 10046741 A | 8/1996 | WO | WO 96-14482 | 5/1996 |
| JP | 11241448 A | 2/1998 | WO | WO 97/28342 | 8/1997 |
| JP | 200154612 A | 6/2000 | WO | WO 01/36191 A1 | 5/2001 |
| JP | 2004027497 A | 6/2002 | | | |
| NZ | 19354 | 9/1984 | | | |

* cited by examiner

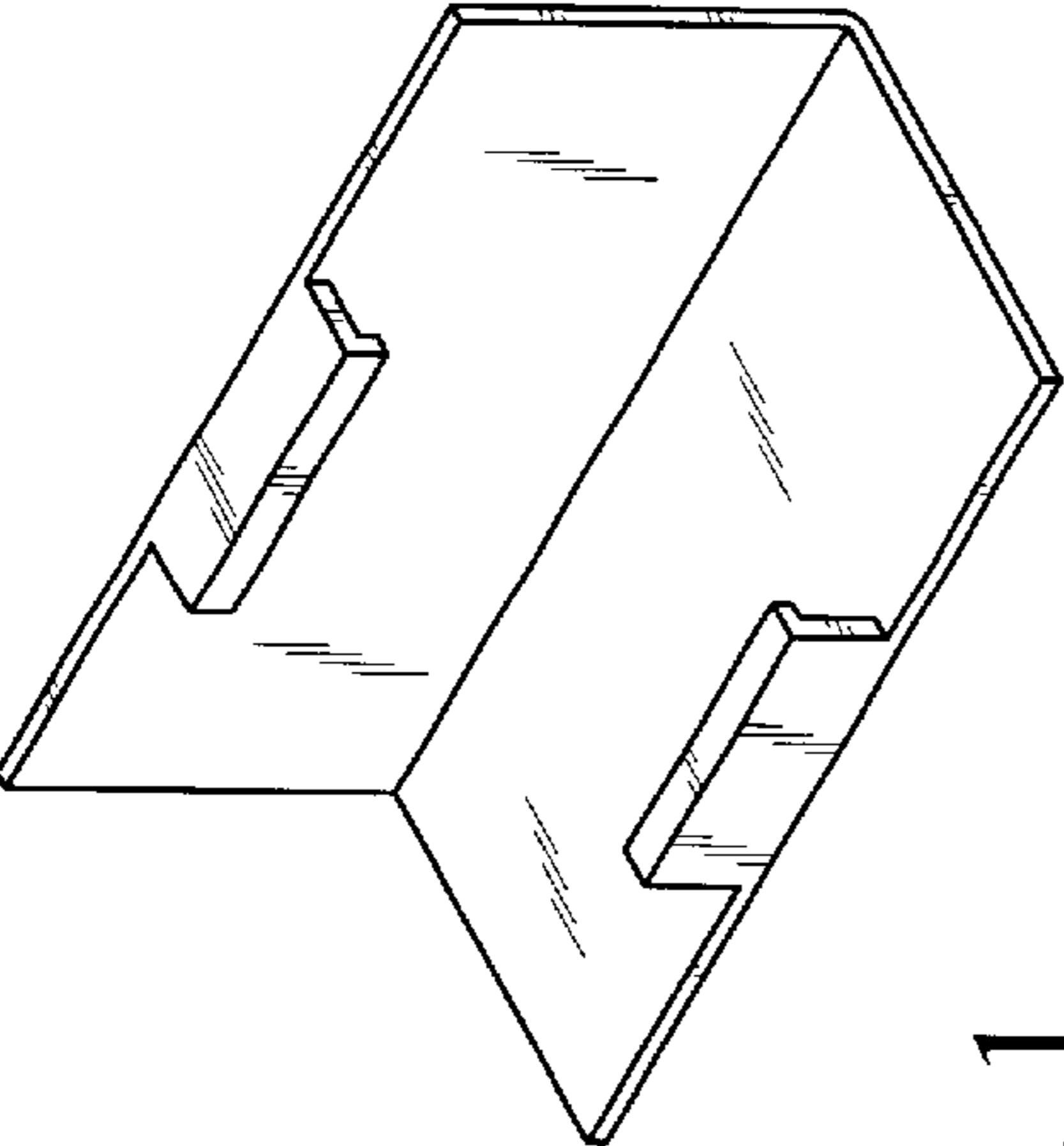

FIG. 1

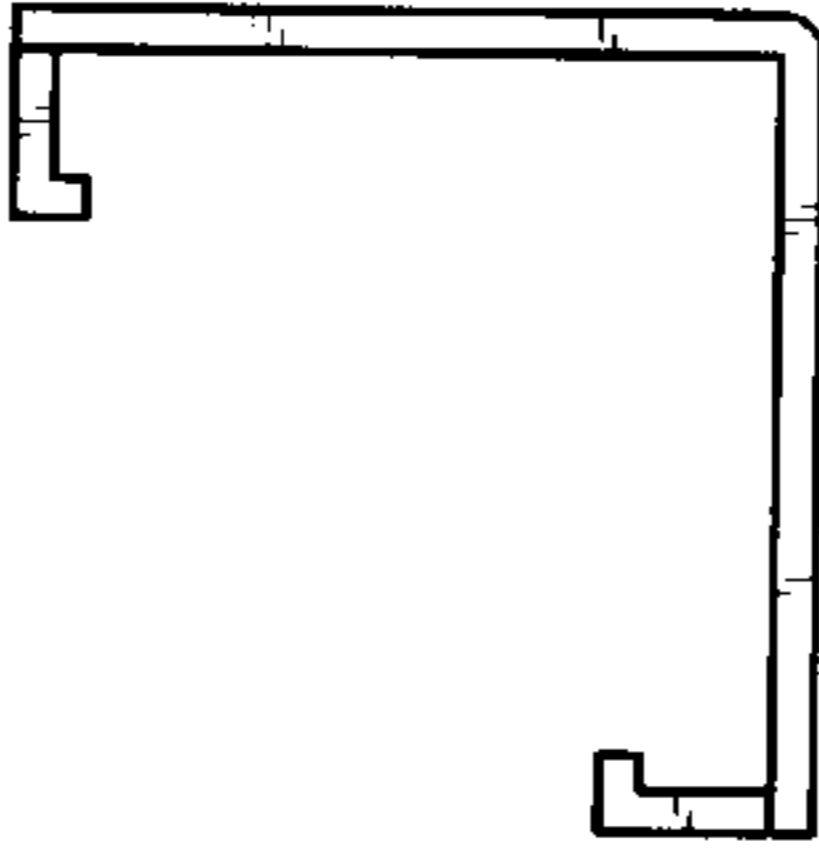

FIG. 2

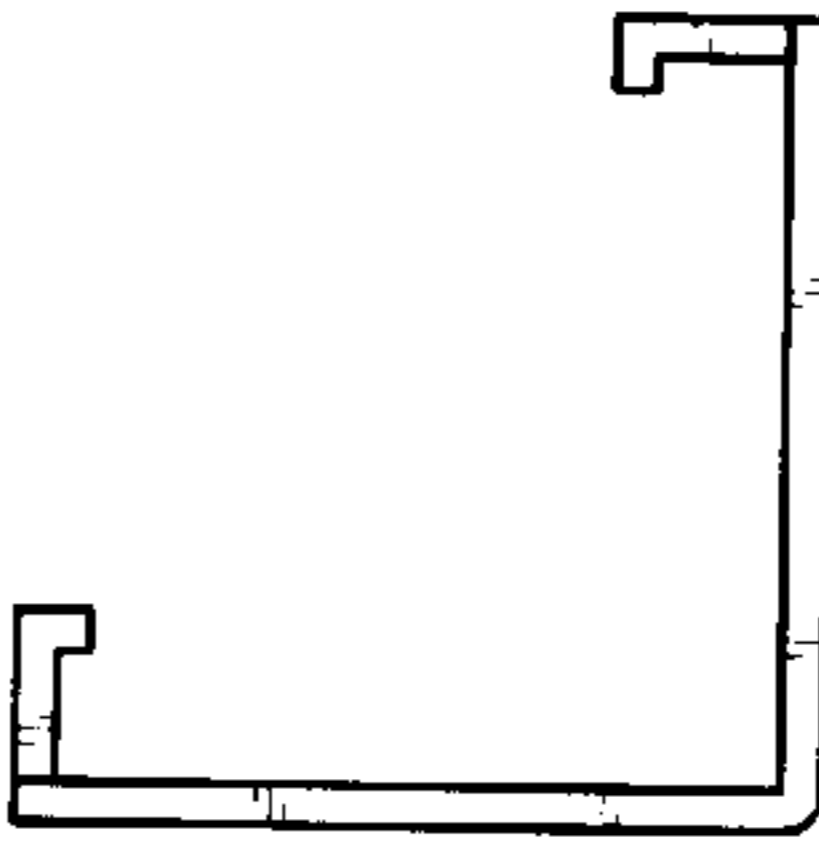

FIG. 3

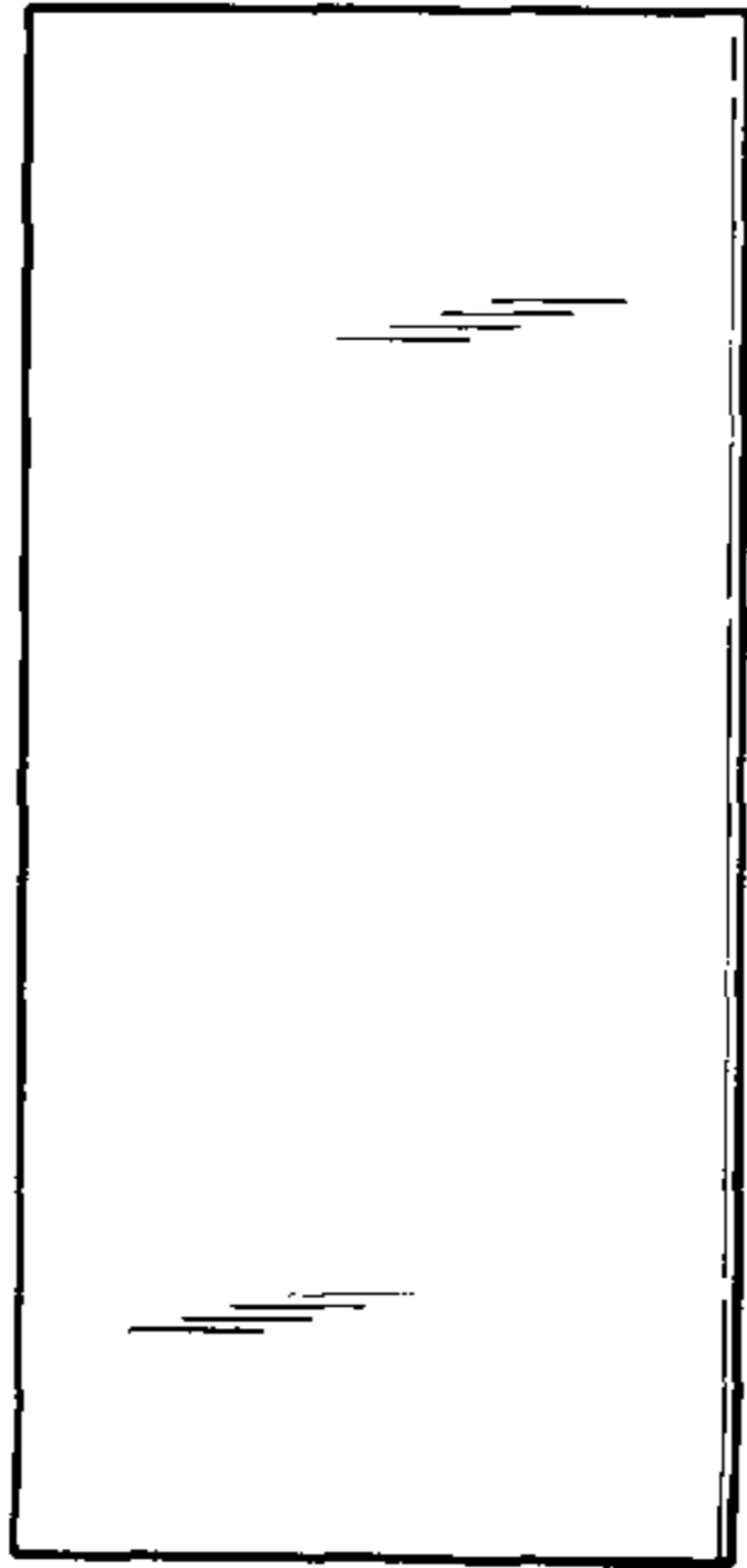

FIG. 4

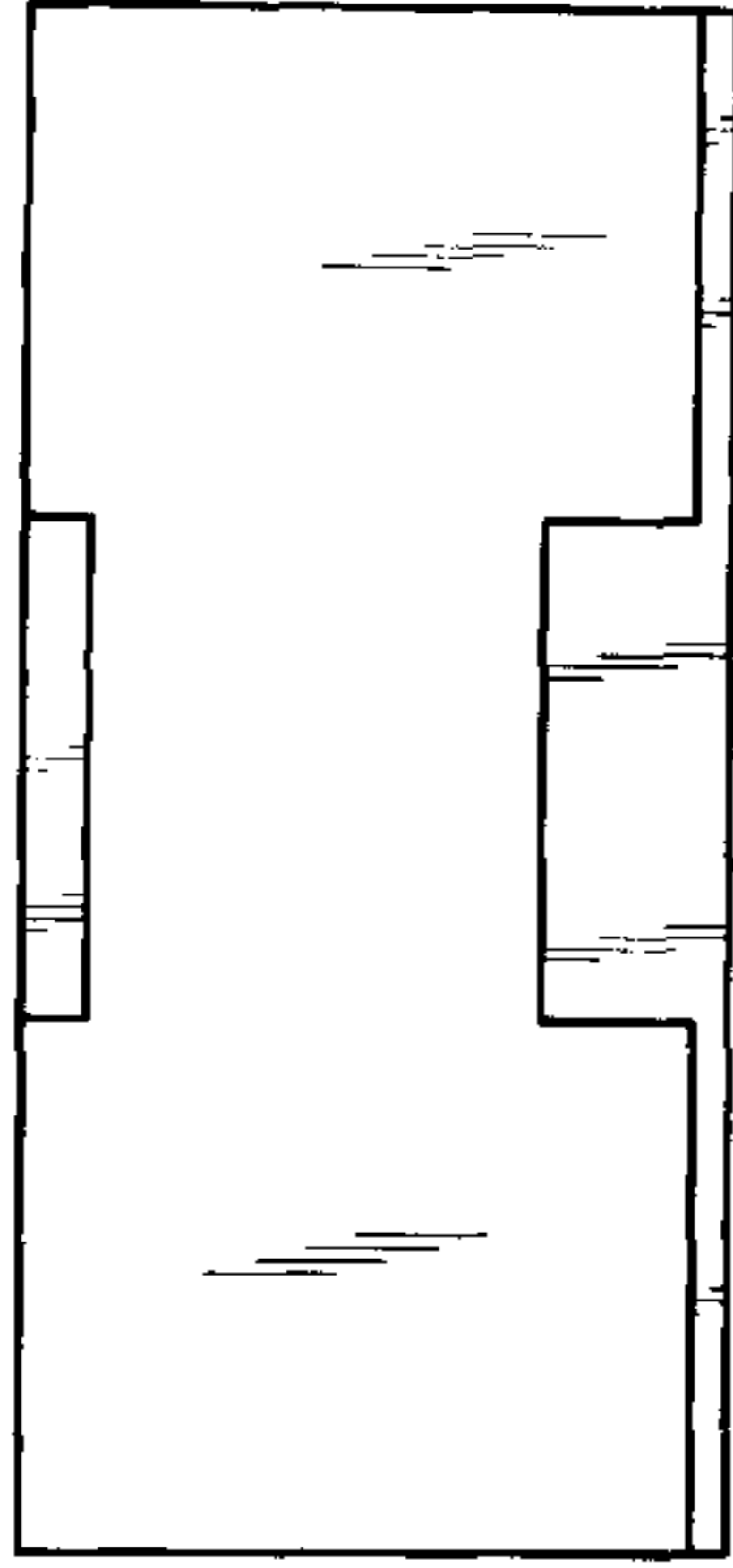

FIG. 5

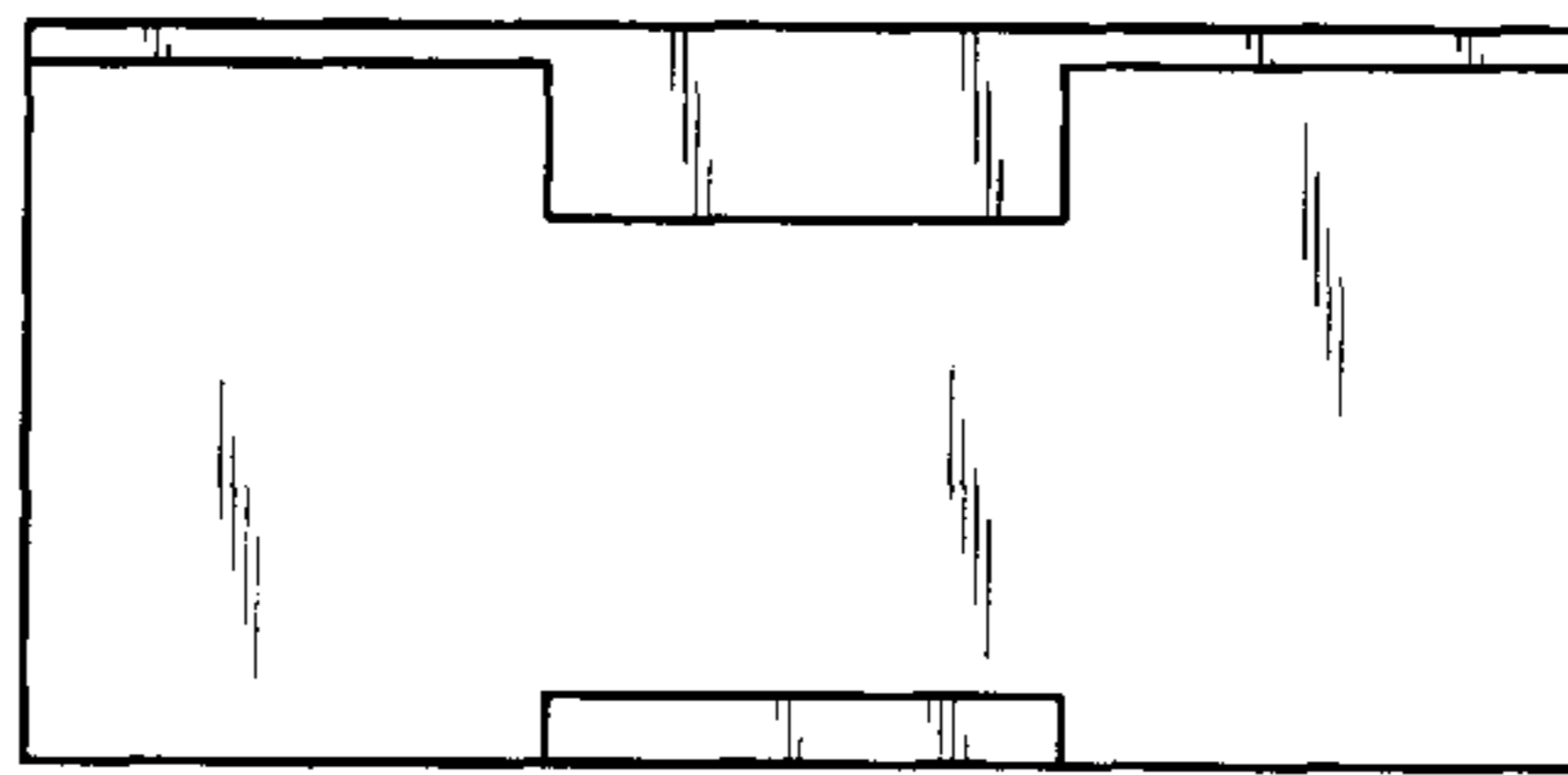

FIG. 6

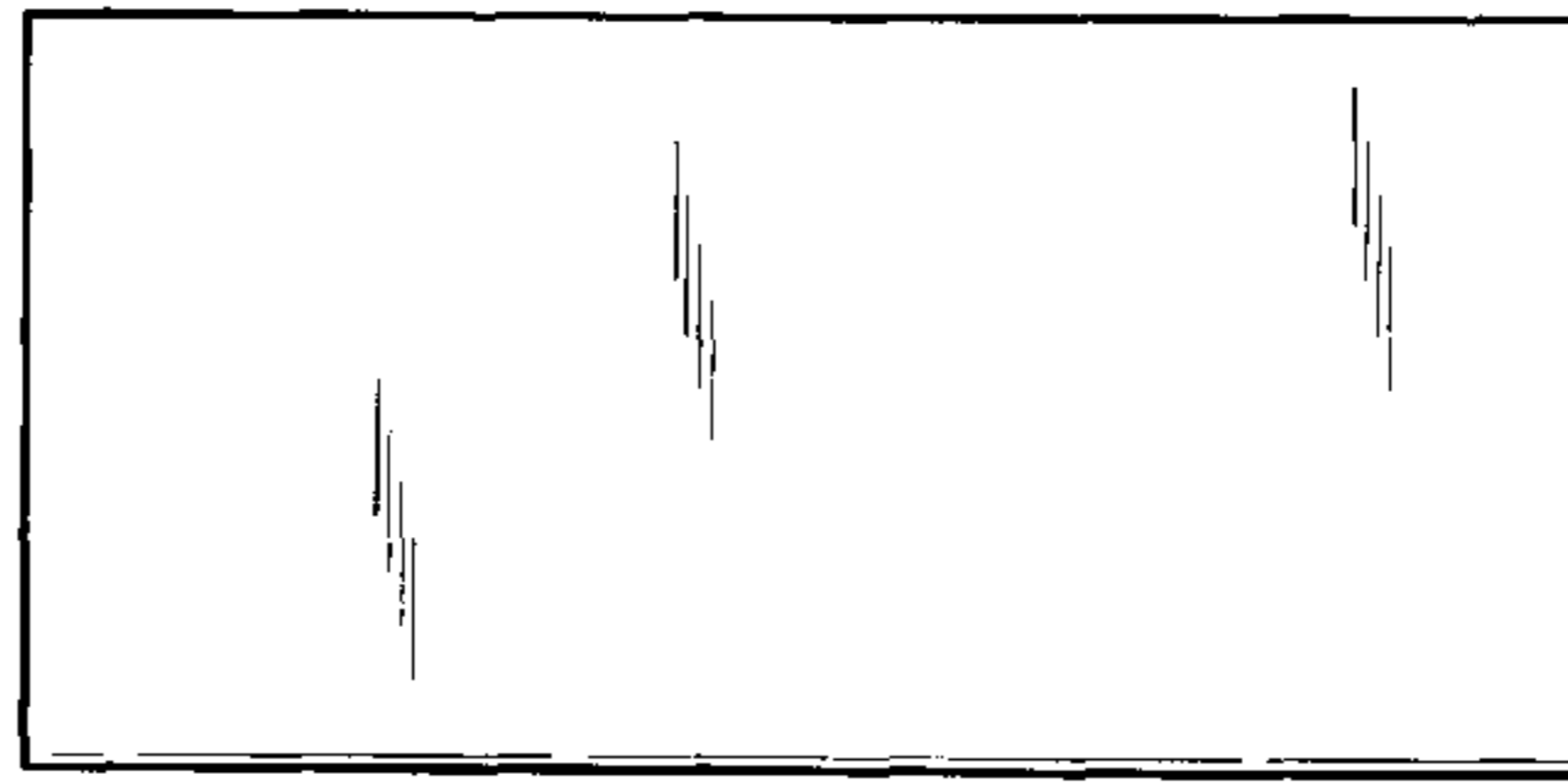

FIG. 7