



US00D528668S

(12) **United States Design Patent**
Wyatt

(10) **Patent No.:** **US D528,668 S**
(45) **Date of Patent:** **** Sep. 19, 2006**

- (54) **LOUVERED HANDRAIL/PRIVACY SCREEN KIT**
- (76) Inventor: **Chris Roger Wyatt**, Rd 1 Box 302A, Ocean View, DE (US) 19970
- (**) Term: **14 Years**
- (21) Appl. No.: **29/175,717**
- (22) Filed: **Feb. 10, 2003**
- (51) **LOC (8) Cl.** **25-01**
- (52) **U.S. Cl.** **D25/126; D25/38**
- (58) **Field of Classification Search** D25/126, D25/38, 42, 131, 132, 128; 256/65.01, 66, 256/19, 73; 52/506.06
See application file for complete search history.

(56) **References Cited**

U.S. PATENT DOCUMENTS

- 2,906,506 A * 9/1959 Barnes et al. 256/19
- D359,813 S * 6/1995 Hoffman et al. D25/131
- 6,276,654 B1 * 8/2001 Perkins 52/506.06

* cited by examiner

Primary Examiner—Doris Clark

(57) **CLAIM**

I claim the ornamental design for a louvered handrail/privacy screen kit, as shown and described.

DESCRIPTION

An object of this invention is the ready application of louver stock through the supports without the necessity of extraneous securing means for the louver stock and yet which possesses a high degree of strength and endurance. An additional object of this invention is to provide a privacy screen structure preferably having its components or elements manufactured from wood polymer lumber, molded polymer compound, or similar rigid material. Wherein the posts are formed in such manner as to enable these elements to be quickly and easily assembled in proper relationship

without the exercise of unusual skill and without requiring special tools or implements.

FIG. 1 is a perspective view of the louvered handrail/privacy screen kit showing my new design;

FIG. 2 is an enlarged perspective view of louver support of the louvered handrail/privacy screen kit with figured top in FIG. 1;

FIG. 3 is the opposite side of louver support of the louvered handrail/privacy screen kit with figured top in FIG. 2;

FIG. 4 is an enlarged perspective view of the medium height louver support of the louvered handrail/privacy screen kit in FIG. 1;

FIG. 5 is the opposite side of medium height louver support of the louvered handrail/privacy screen kit in FIG. 4;

FIG. 6 is an enlarged perspective view of louver support of the louvered handrail/privacy screen kit in FIG. 1;

FIG. 7 is the opposite side of louver support of the louvered handrail/privacy screen kit shown in FIG. 6;

FIG. 8 is an enlarged perspective view of the short louver support of the louvered handrail/privacy screen kit in FIG. 1;

FIG. 9 is the opposite side of the short louver support of the louvered handrail/privacy screen kit shown in FIG. 8;

FIG. 10 is an enlarged perspective view of corner louver support of the louvered handrail/privacy screen kit in FIG. 1;

FIG. 11 is the opposite side of corner louver support of the louvered handrail/privacy screen kit shown in FIG. 10;

FIG. 12 is an enlarged perspective view of transitional louver support of the louvered handrail/privacy screen kit in FIG. 1;

FIG. 13 is the opposite side of transitional louver support of the louvered handrail/privacy screen kit shown in FIG. 12; and,

FIG. 14 is an enlarged perspective view of molded louver support of the louvered handrail/privacy screen kit in FIG. 1; opposite side is mirror image.

The broken lines are for illustrative purposes only and form no part of the claimed design. The bottom of all FIGS. 1 through 14 are unadorned similar to the top of FIGS. 4 through 13.

1 Claim, 8 Drawing Sheets

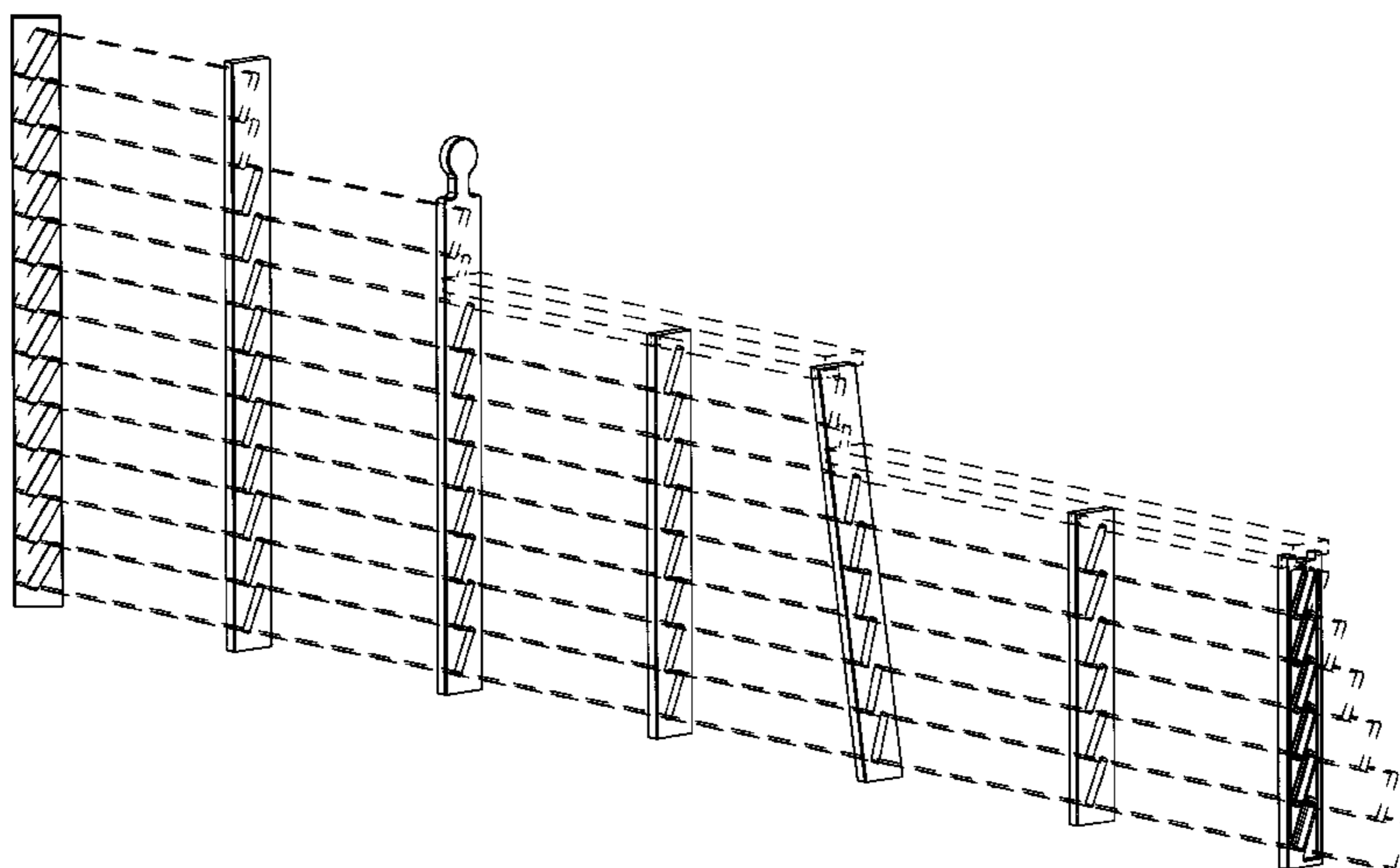

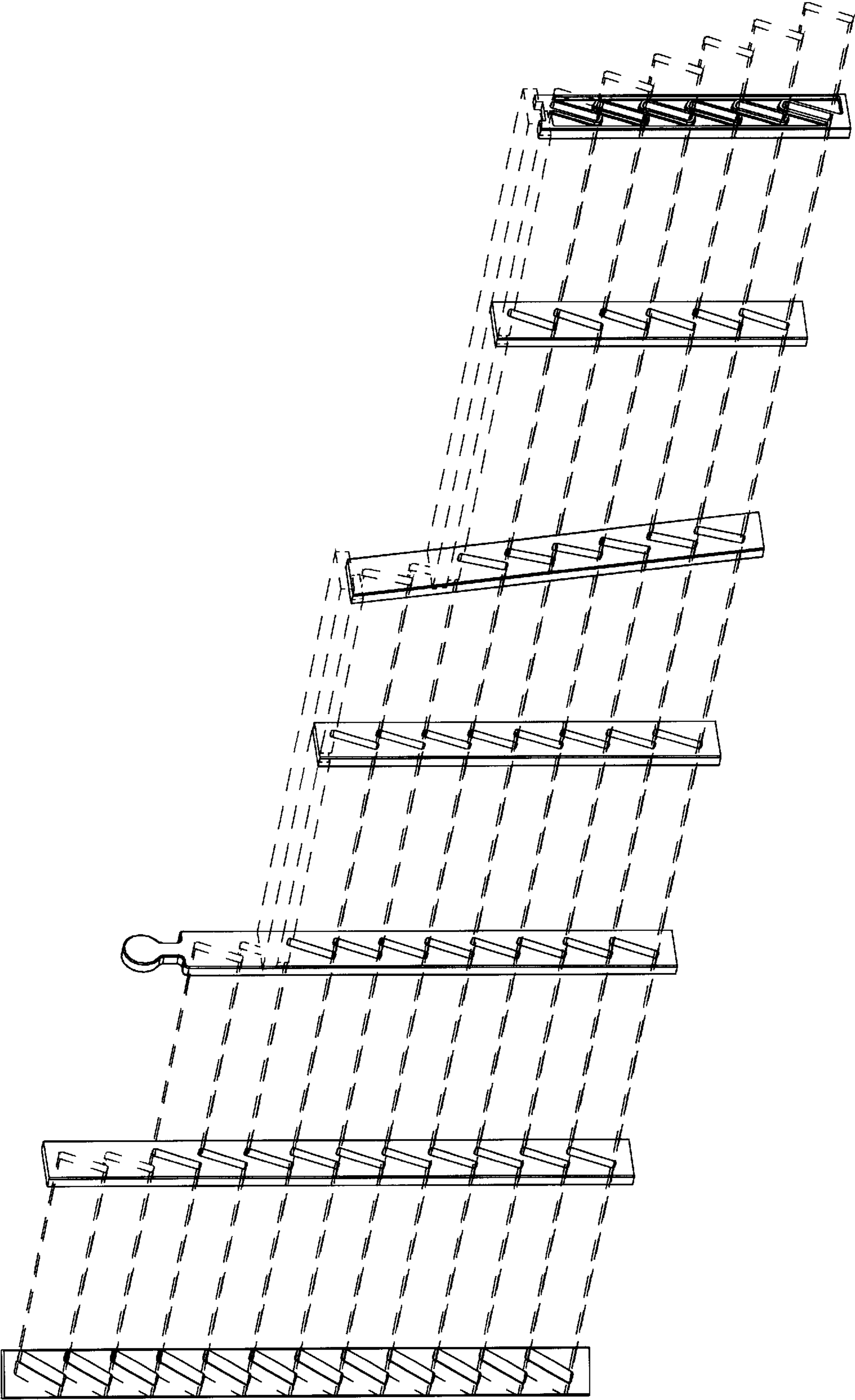

Fig. 1

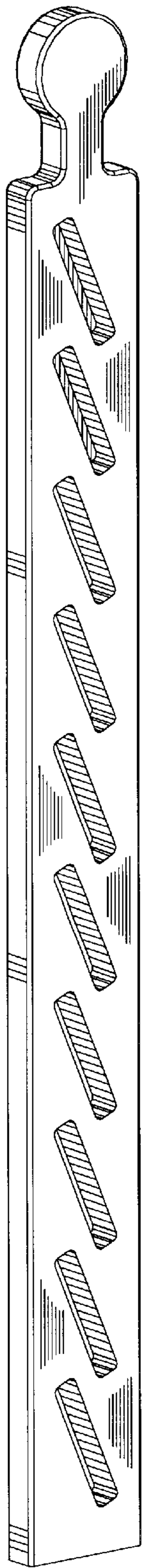

Fig. 2

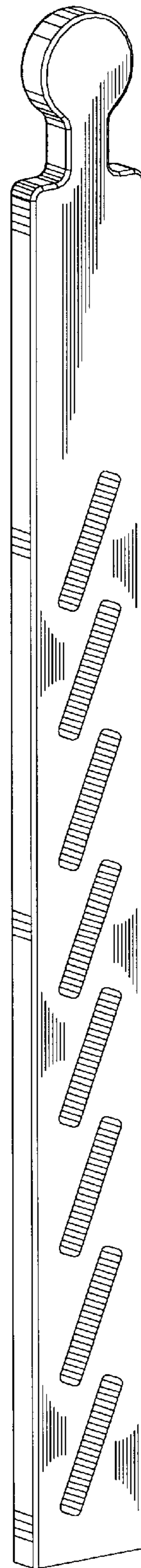

Fig. 3

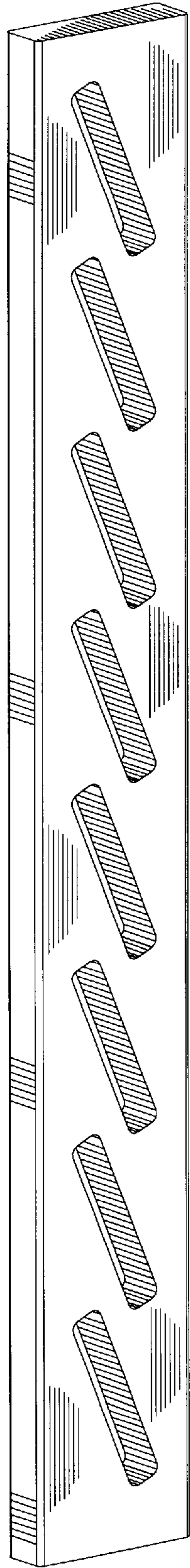

Fig. 4

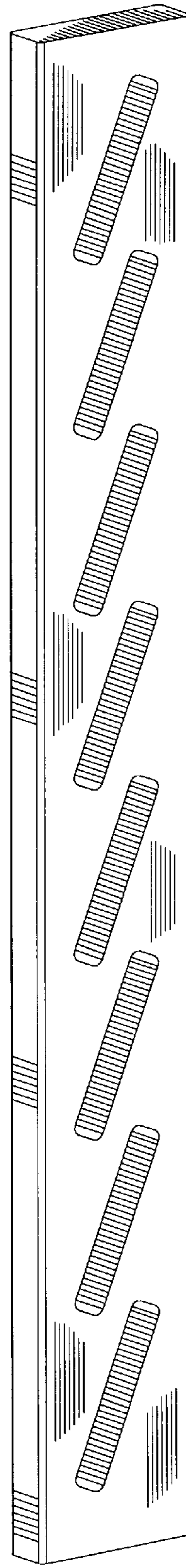

Fig. 5

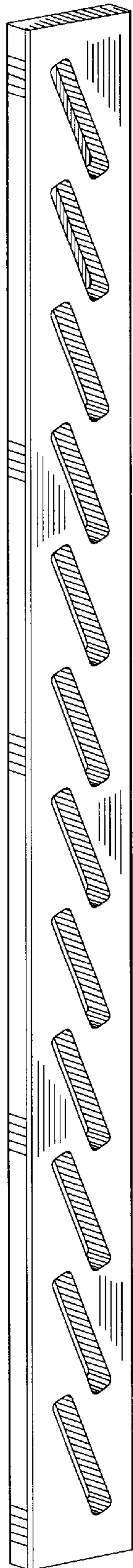

Fig. 6

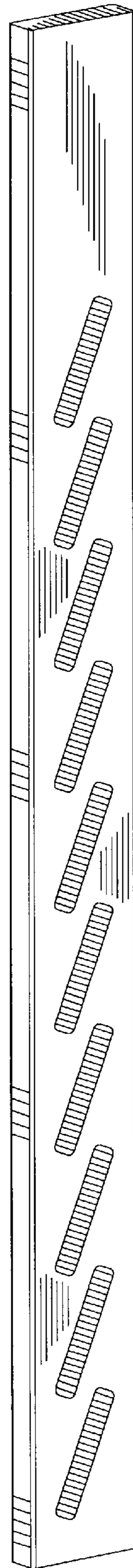

Fig. 7

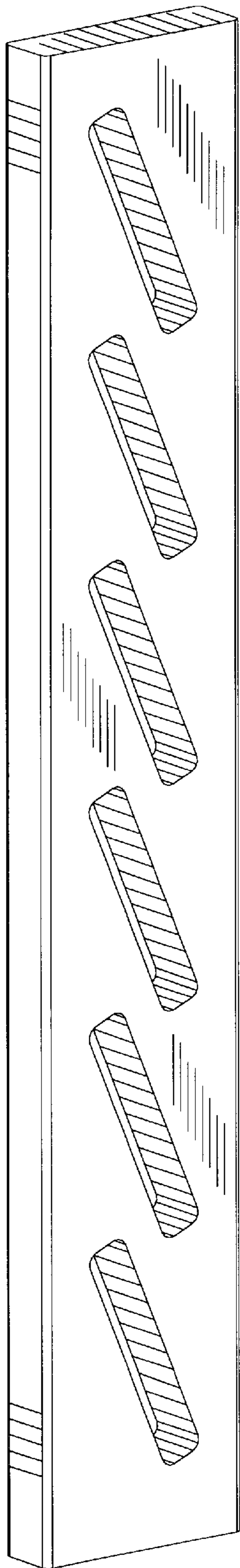

Fig. 8

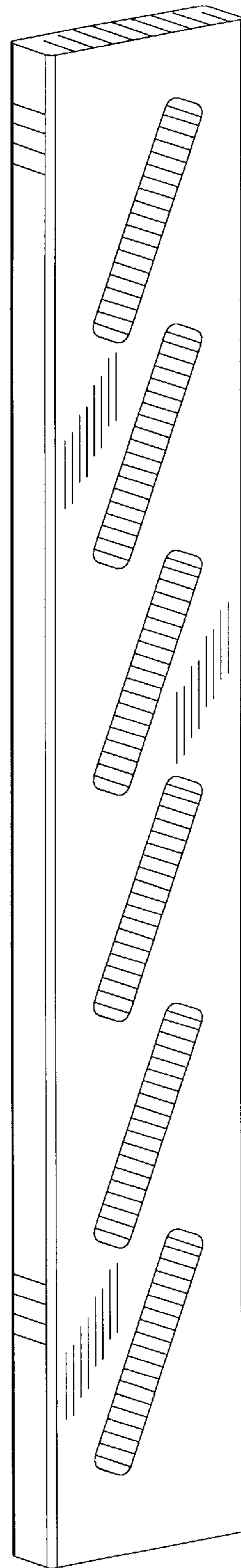

Fig. 9

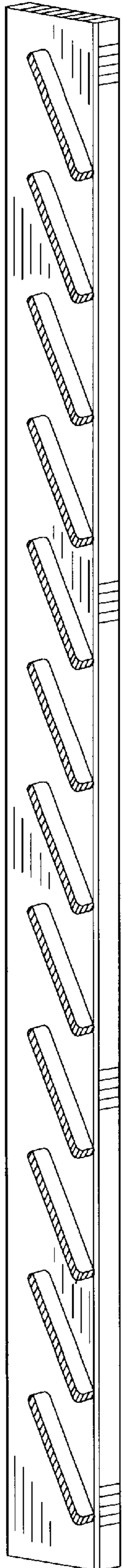

Fig. 10

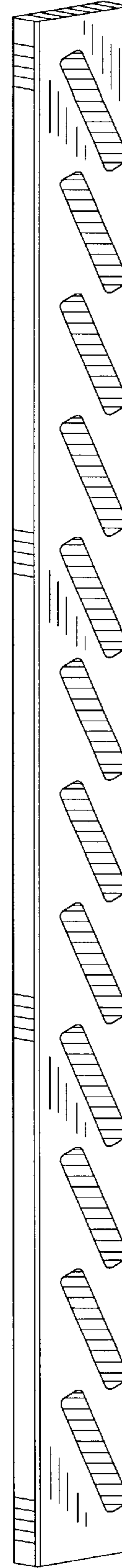

Fig. 11

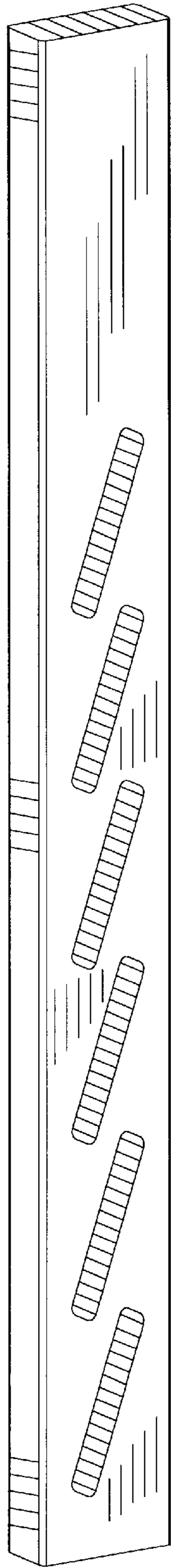

Fig. 12

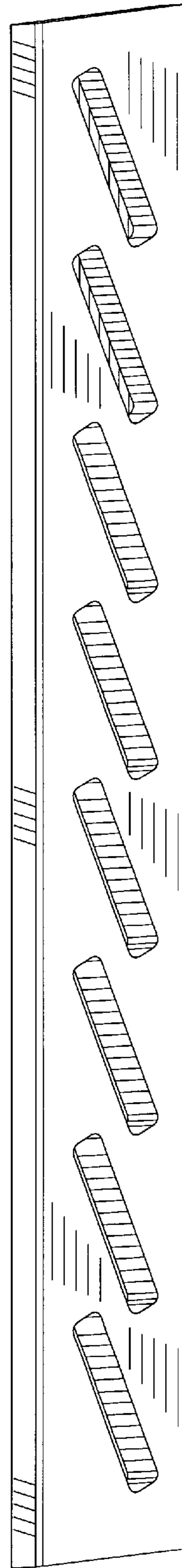

Fig. 13

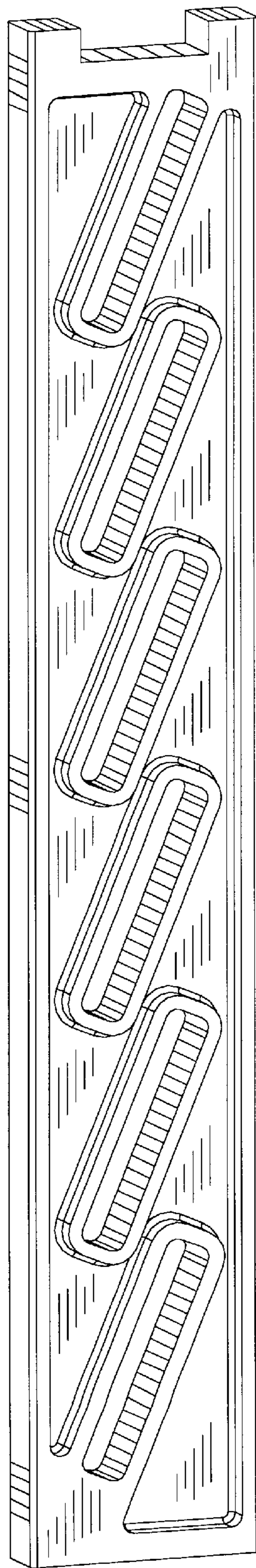

Fig. 14