

US00D528650S

(12) **United States Design Patent**
Shapiro

(10) **Patent No.:** **US D528,650 S**

(45) **Date of Patent:** **** Sep. 19, 2006**

(54) **BODY FOR A VERTICAL FAN**

D483,466 S * 12/2003 Shapiro D23/378

(75) Inventor: **Barry Shapiro**, Doylestown, PA (US)

* cited by examiner

(73) Assignee: **Lasko Holdings, Inc.**, Wilmington, DE (US)

Primary Examiner—Lisa Lichtenstein

(74) *Attorney, Agent, or Firm*—RatnerPrestia

(**) Term: **14 Years**

(57) **CLAIM**

The ornamental design for a body for a vertical fan, as shown and described.

(21) Appl. No.: **29/233,738**

(22) Filed: **Jul. 8, 2005**

DESCRIPTION

(51) **LOC (8) Cl.** **23-04**

(52) **U.S. Cl.** **D23/411**

(58) **Field of Classification Search** D23/378,
D23/370, 411, 381; 416/244 R, 247 R; 415/53.1–53.3;
392/365, 367

See application file for complete search history.

FIG. 1 is a right side front perspective view of a body for a vertical fan showing my new design;

FIG. 2 is a rear perspective view thereof;

FIG. 3 is a front elevation view thereof;

FIG. 4 is a side elevation view thereof, the opposite side being a mirror image of that shown;

FIG. 5 is a rear elevation view thereof; and,

FIG. 6 is an enlarged top plan view thereof.

The broken line showing of environmental structure in FIGS. 1–6 is for illustrative purposes only and forms no part of the claimed design.

(56) **References Cited**

U.S. PATENT DOCUMENTS

D423,093 S * 4/2000 Fok D23/378

D479,874 S * 9/2003 Shapiro D23/378

1 Claim, 6 Drawing Sheets

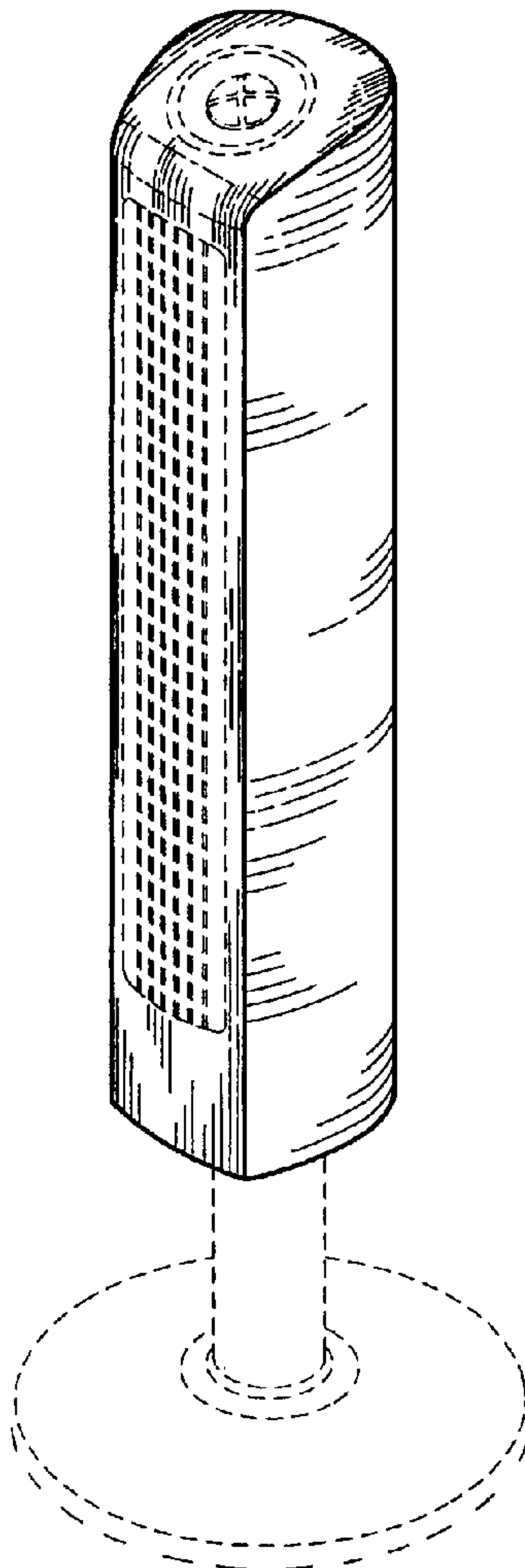

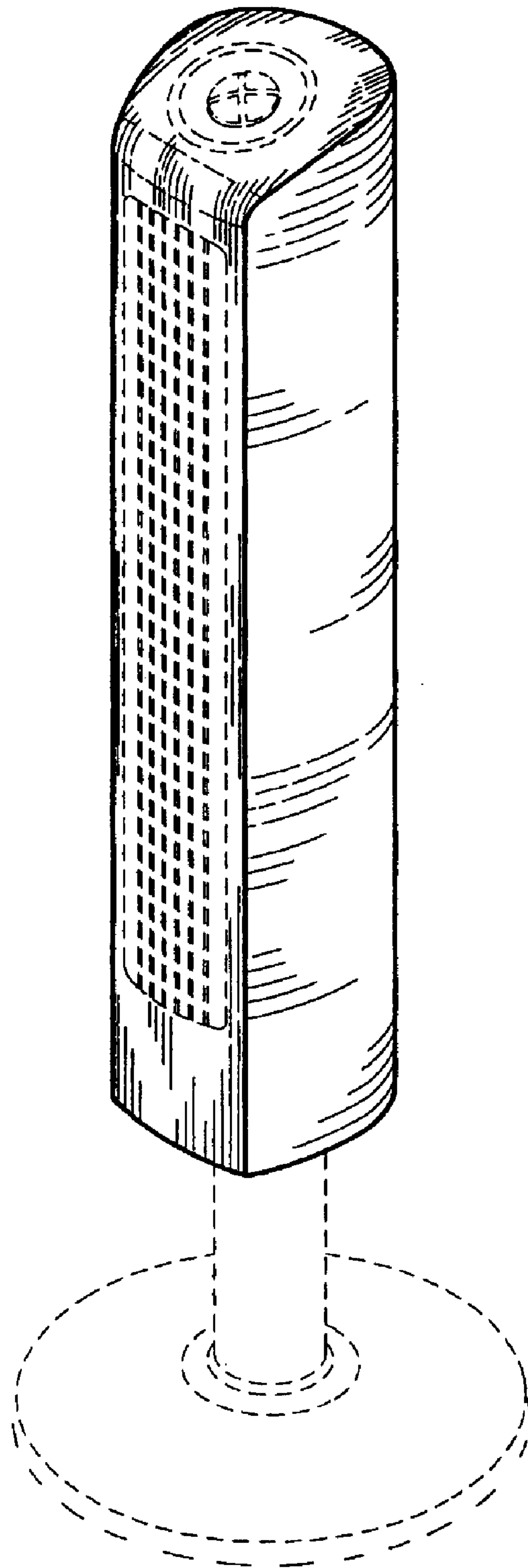

FIG. 1

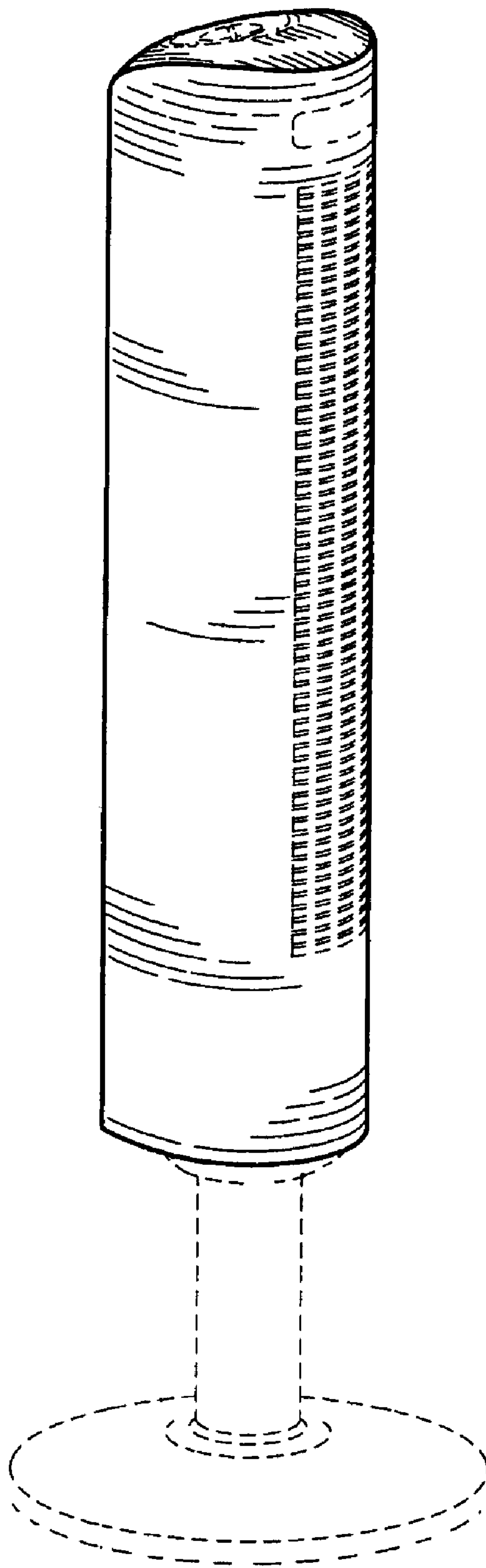

FIG. 2

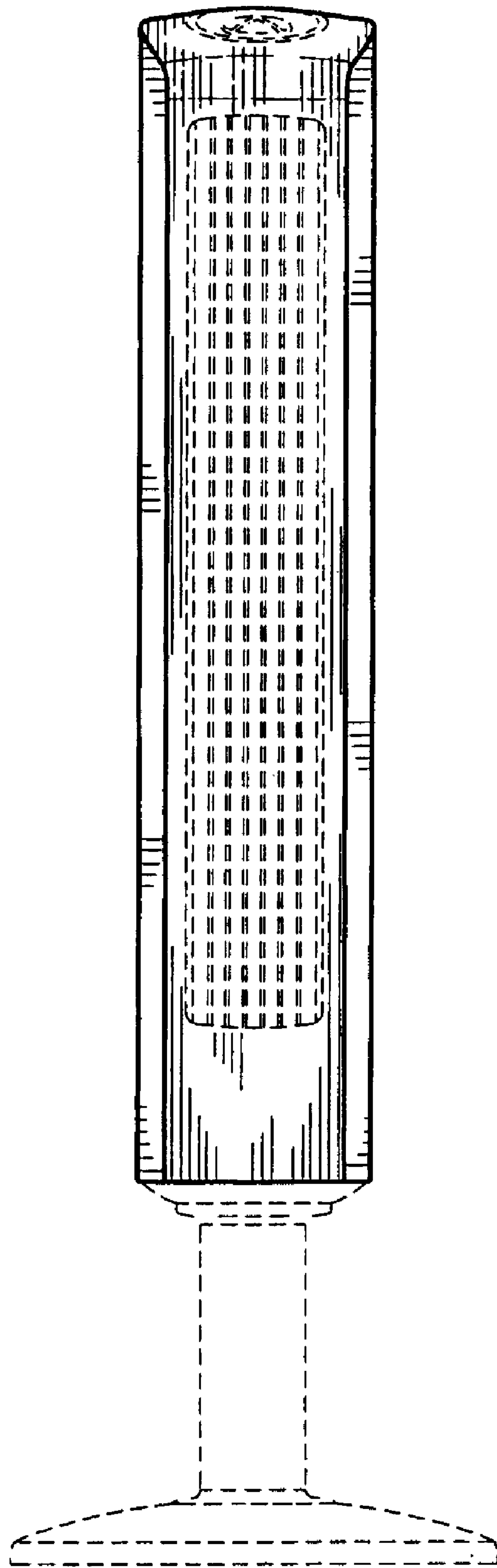

FIG. 3

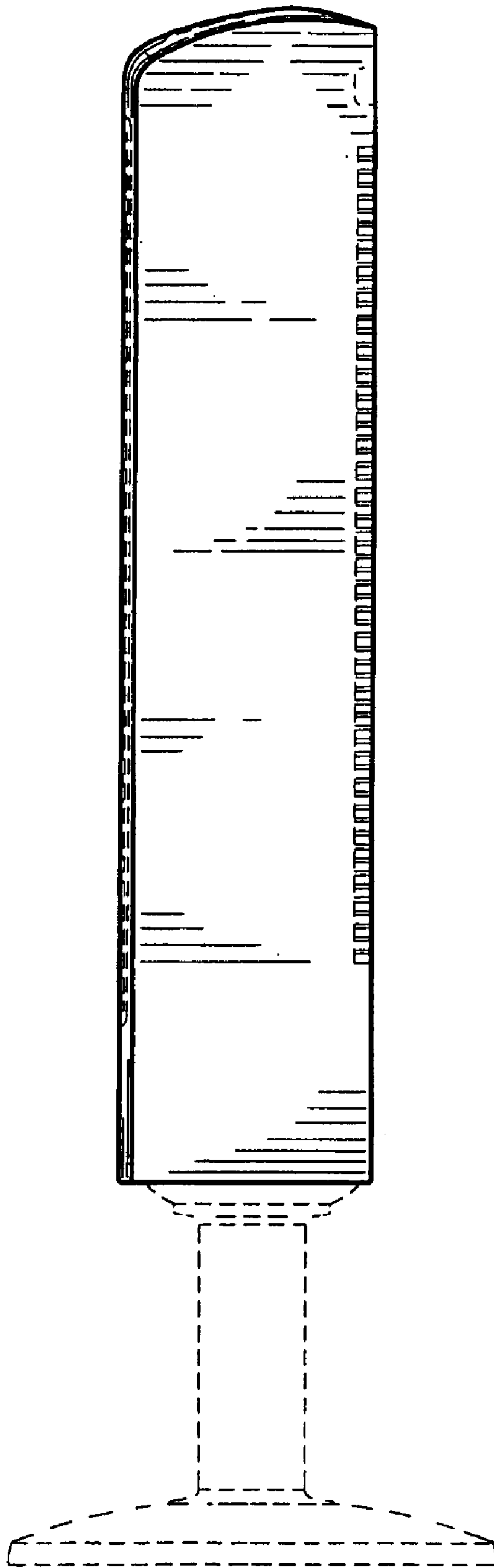

FIG. 4

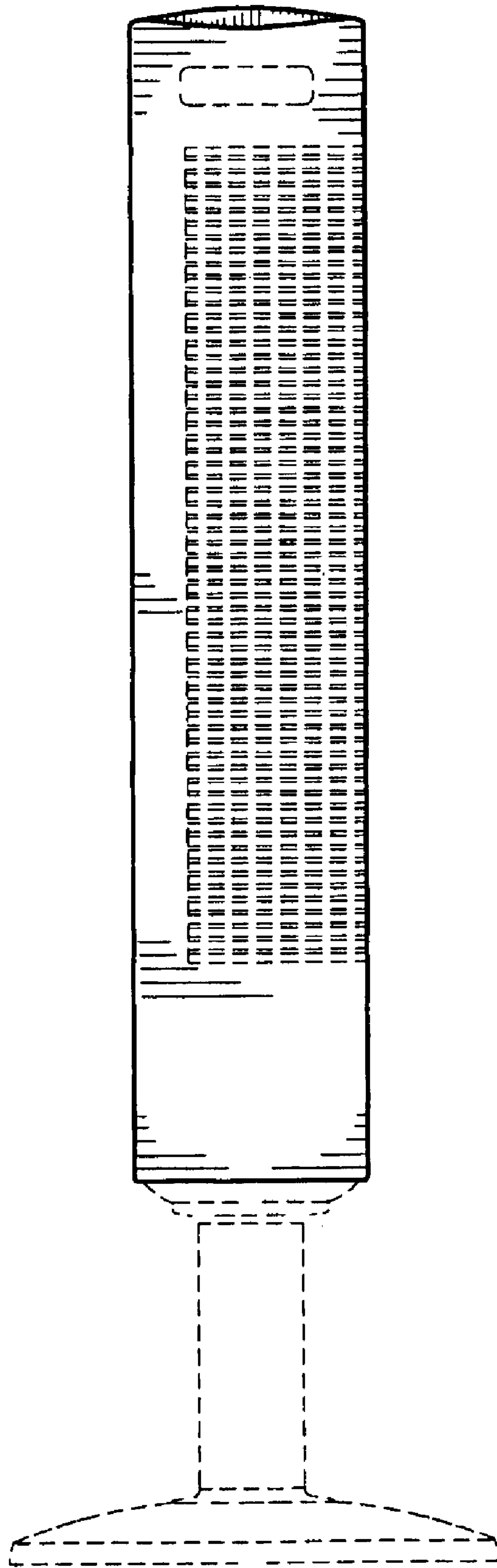

FIG. 5

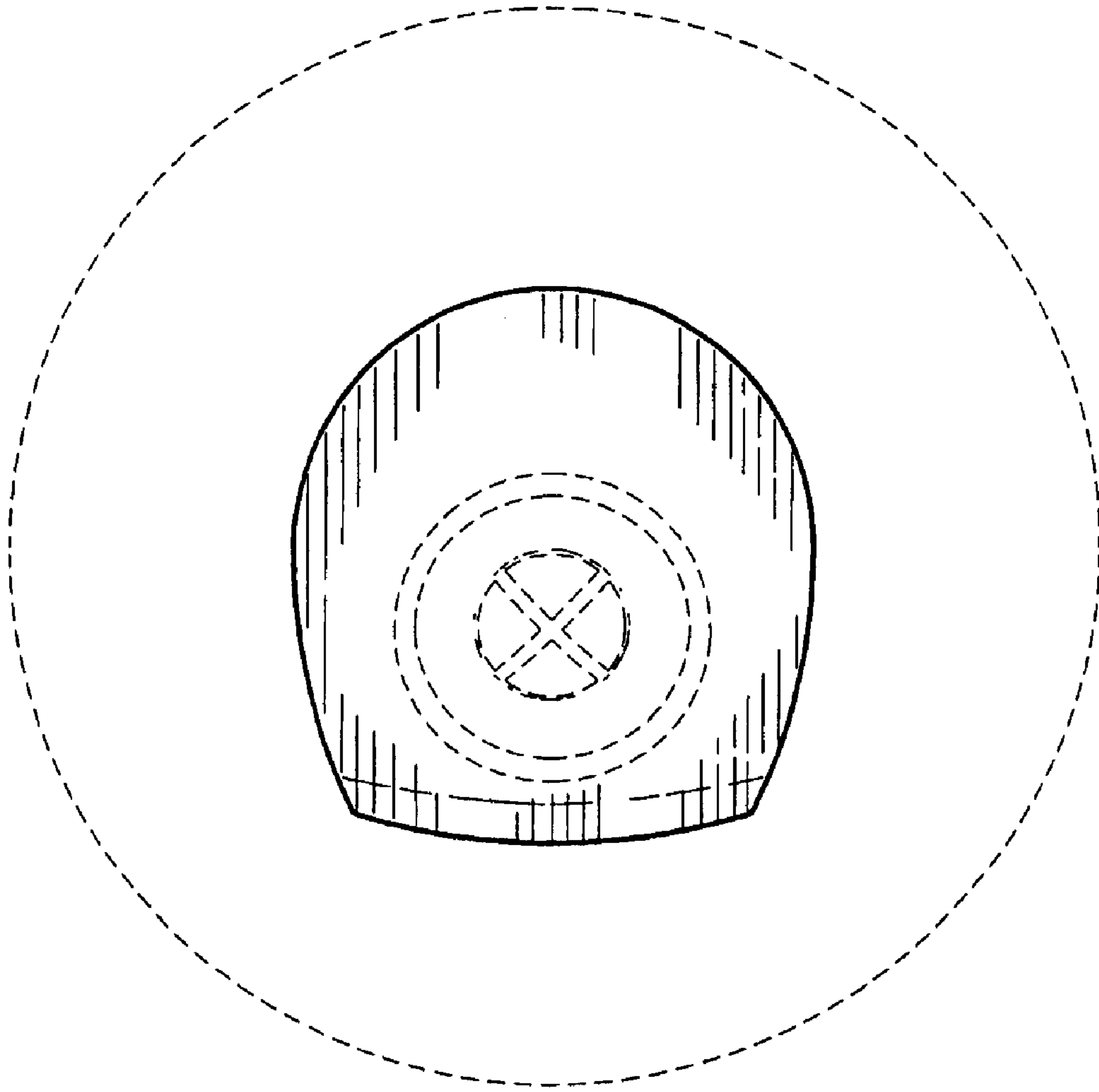

FIG. 6