



US00D528643S

(12) **United States Design Patent**  
**Wang**

(10) **Patent No.:** **US D528,643 S**

(45) **Date of Patent:** **\*\* Sep. 19, 2006**

(54) **MINI AIR PURIFIER**

(76) Inventor: **Chi-Hsiang Wang**, 12F-6, No. 16 Jian Ba Rdon, Chung Ho, Taipei Hsieng (TW), 235

(\*\*) Term: **14 Years**

(21) Appl. No.: **29/216,957**

(22) Filed: **Nov. 12, 2004**

(51) **LOC (8) Cl.** ..... **23-04**

(52) **U.S. Cl.** ..... **D23/364**

(58) **Field of Classification Search** ..... D23/355,  
D23/364, 365; 392/404; 361/229, 230  
See application file for complete search history.

(56) **References Cited**

**U.S. PATENT DOCUMENTS**

D437,038 S	*	1/2001	Chuan	.....	D23/364
D495,409 S	*	8/2004	Ke	.....	D23/355
D501,919 S	*	2/2005	Hsin-mao	.....	D23/364

\* cited by examiner

*Primary Examiner*—Robin V. Webster

(74) *Attorney, Agent, or Firm*—Kerry W. Wang; Law Offices of K. W. Wang

(57) **CLAIM**

The ornamental design for an mini air purifier, as shown and described.

**DESCRIPTION**

FIG. 1 is a top, front perspective view of an air purifier showing my new design;

FIG. 2 is a front elevational view thereof, wherein the mark LumiPure™ is shown in broken lines for illustrative purposes only and does not constitute a part of the claimed design;

FIG. 3 is a rear elevational view thereof, the connector prongs being in their vertical positions, wherein the double arrow and the two position signs adjacent to the two position-change enablers are shown in broken lines for illustrative purposes only and form no part of the claimed design;

FIG. 4 is a rear elevational view thereof, the connector prongs being in their horizontal positions, wherein the double arrow and the two position signs adjacent to the two position-change enablers are shown in broken lines for illustrative purposes only and form no part of the claimed design;

FIG. 5 is a top plan view thereof;

FIG. 6 is a bottom plan view thereof;

FIG. 7 is a right side elevational view thereof;

FIG. 8 is a left side elevational view thereof;

FIG. 9 is a top, front perspective view thereof, the lid being lifted exposing the UV lamp inside, wherein the UV lamp, the bracket holding the UV lamp and the ventilation grille are shown in broken lines for illustrative purposes only and do not constitute a part of the claimed design; and,

FIG. 10 is a top, front perspective and explosive view thereof, the lid being lifted, wherein the UV lamp, the bracket holding the UV lamp, the ventilation grille and the plate separating the fan and the UV lamp are all shown in broken lines for illustrative purposes only and do not constitute a part of the claimed design.

**1 Claim, 9 Drawing Sheets**

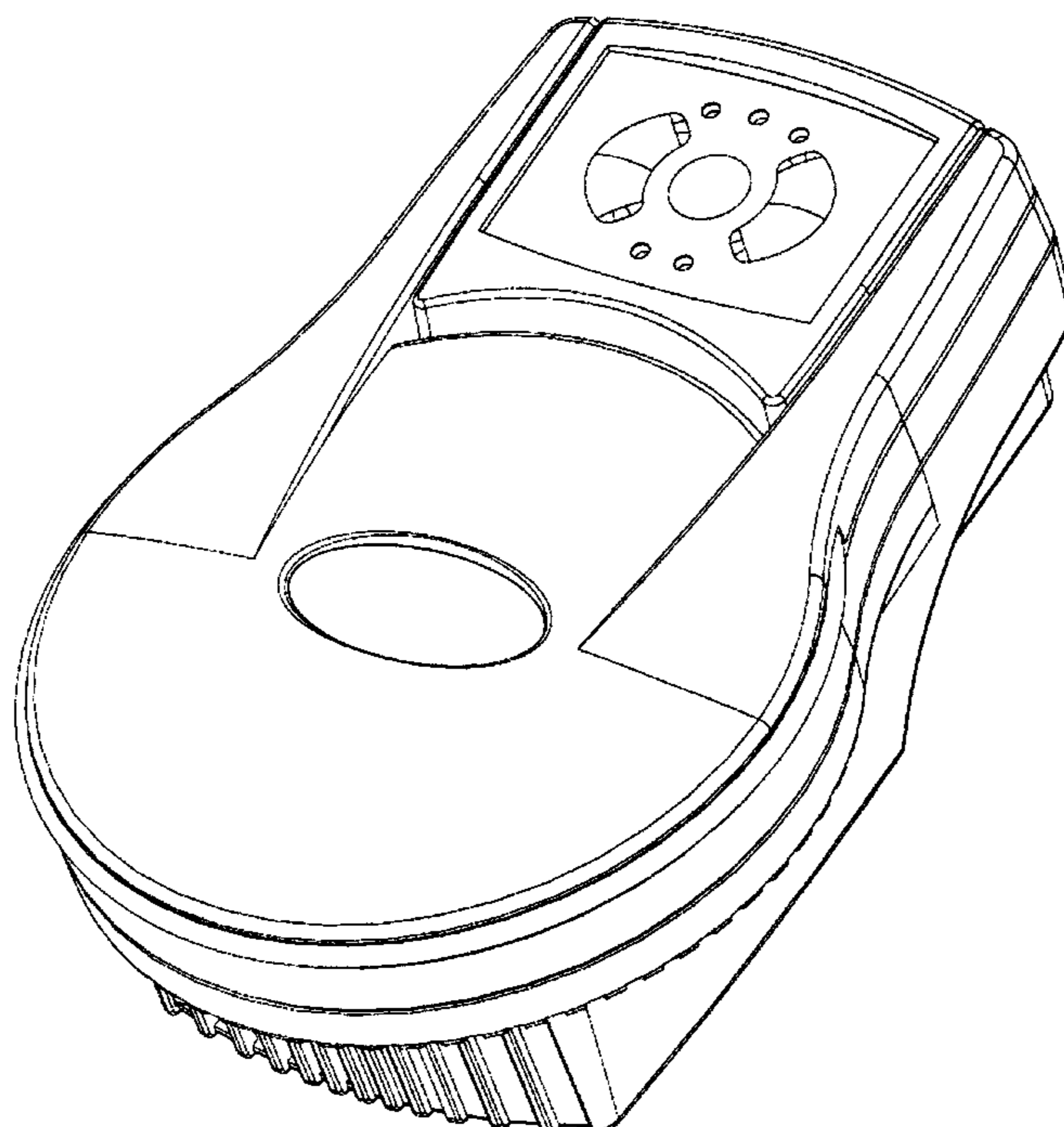

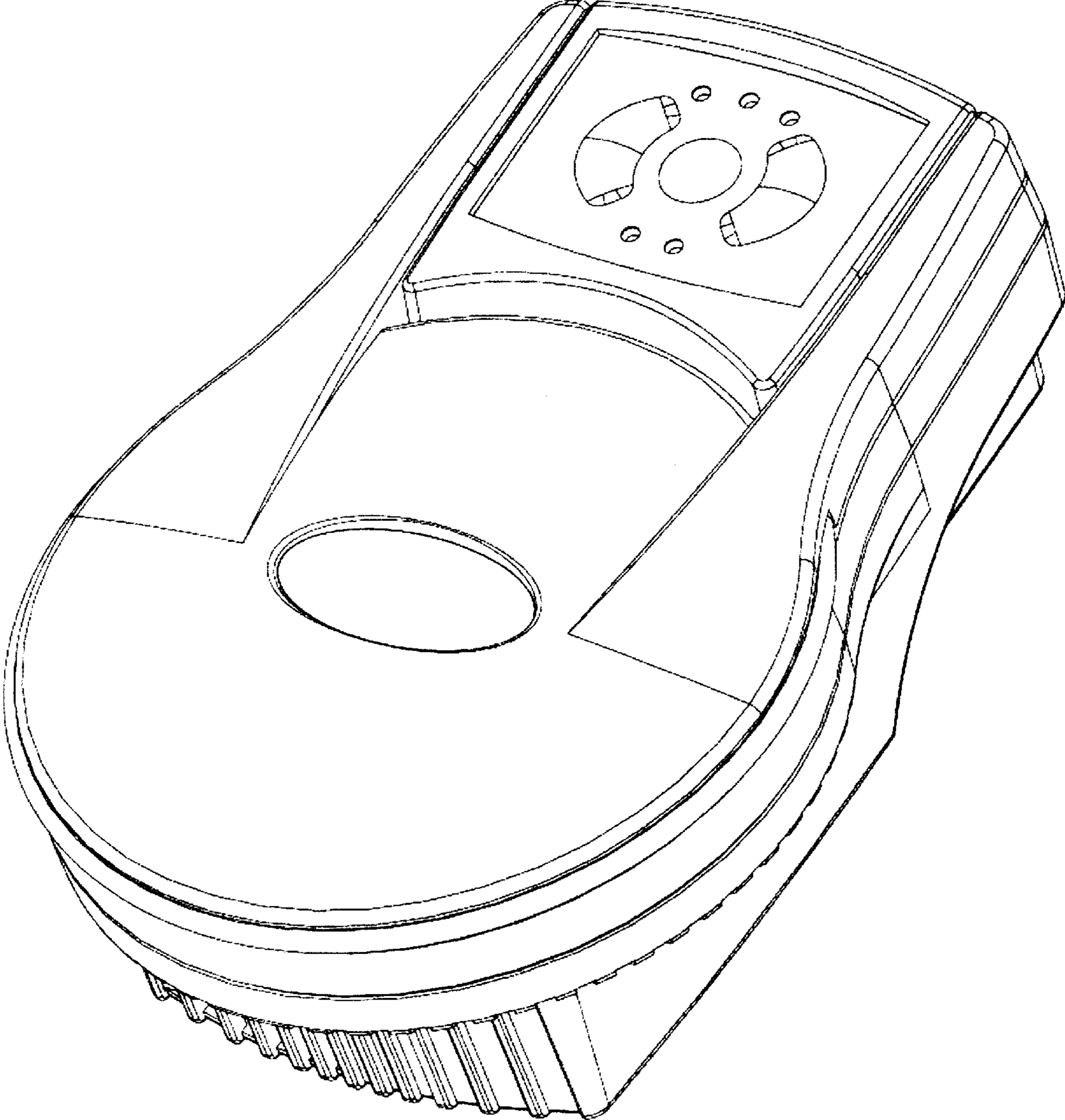

FIG. 1

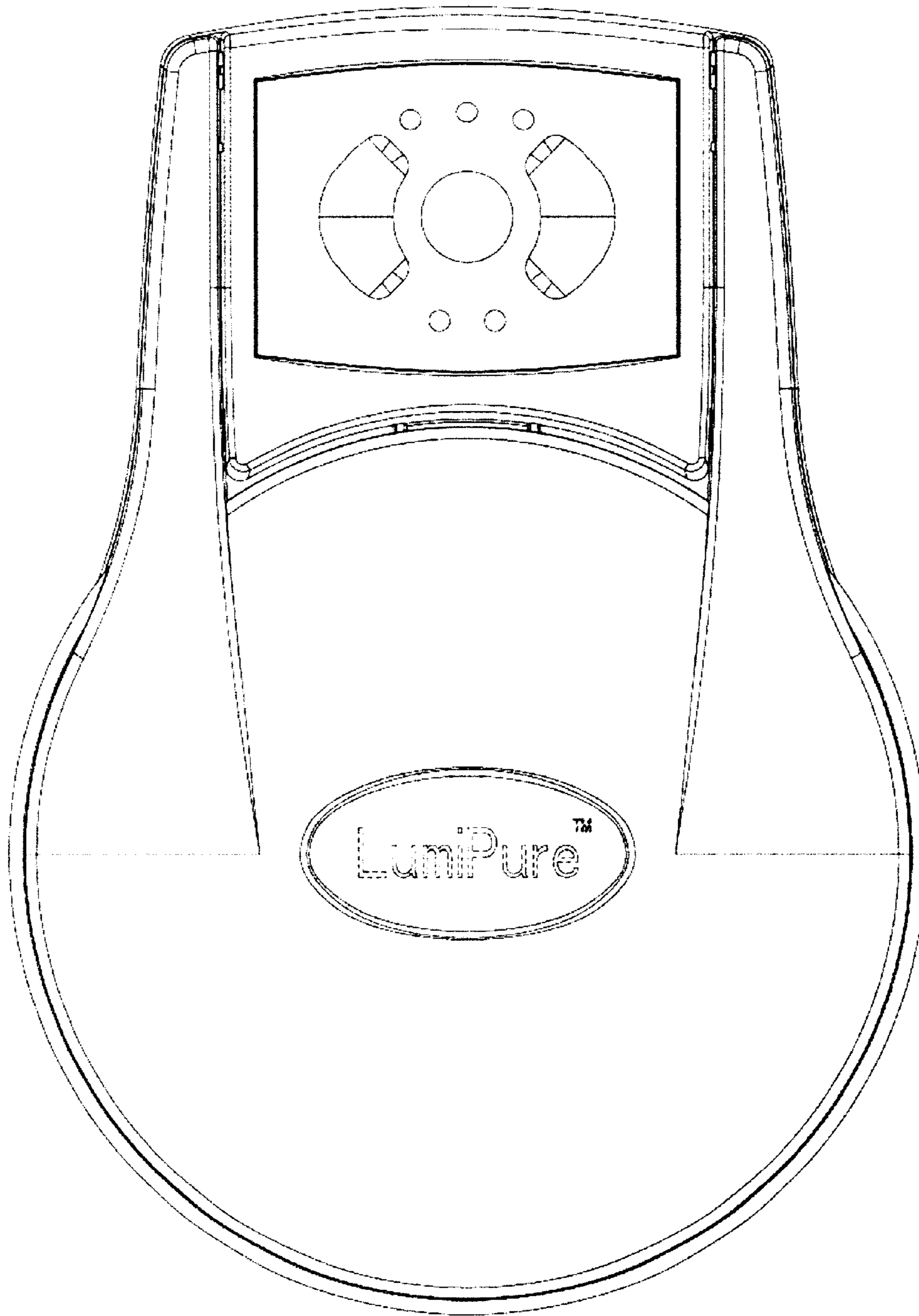

FIG. 2

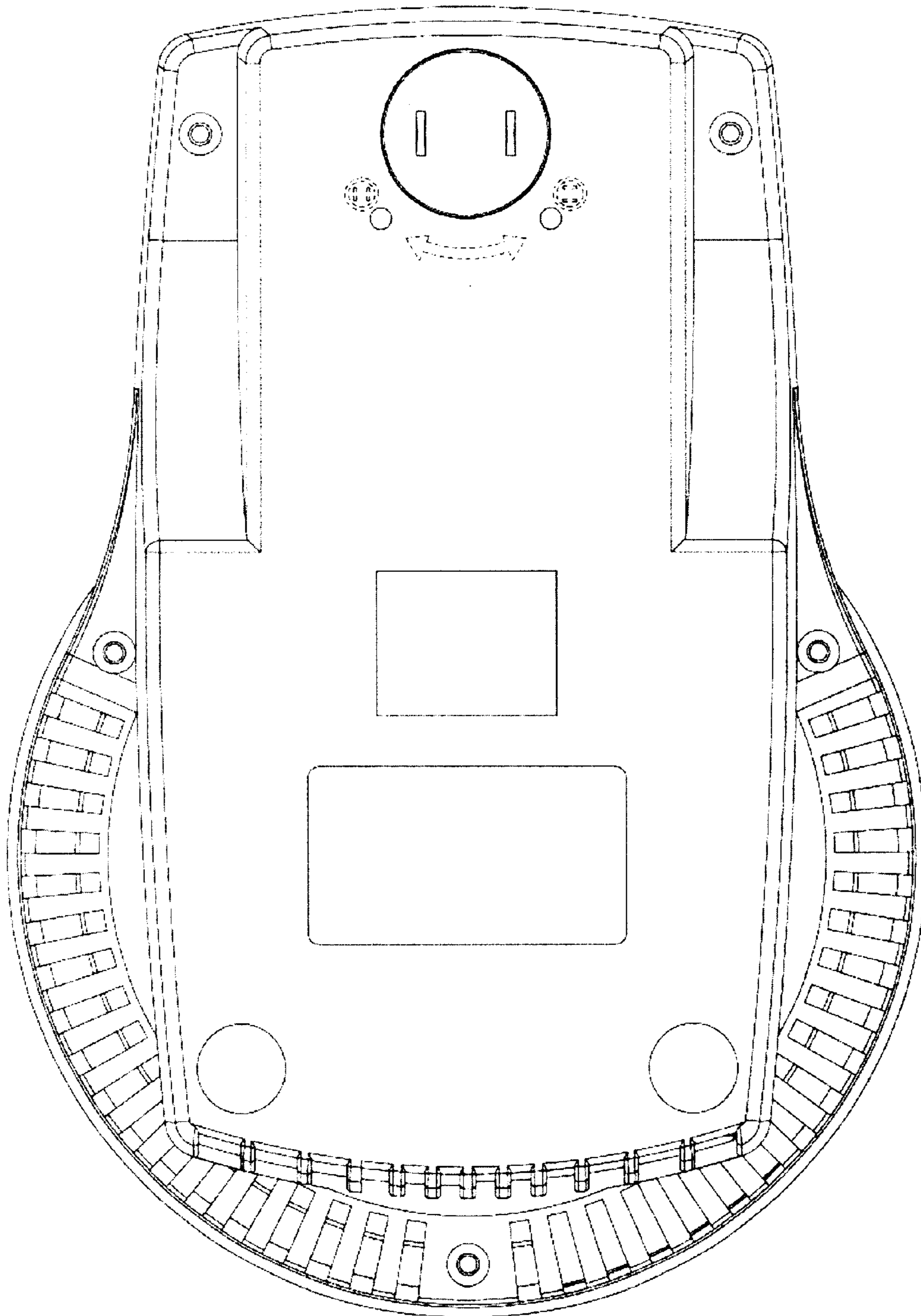

FIG. 3

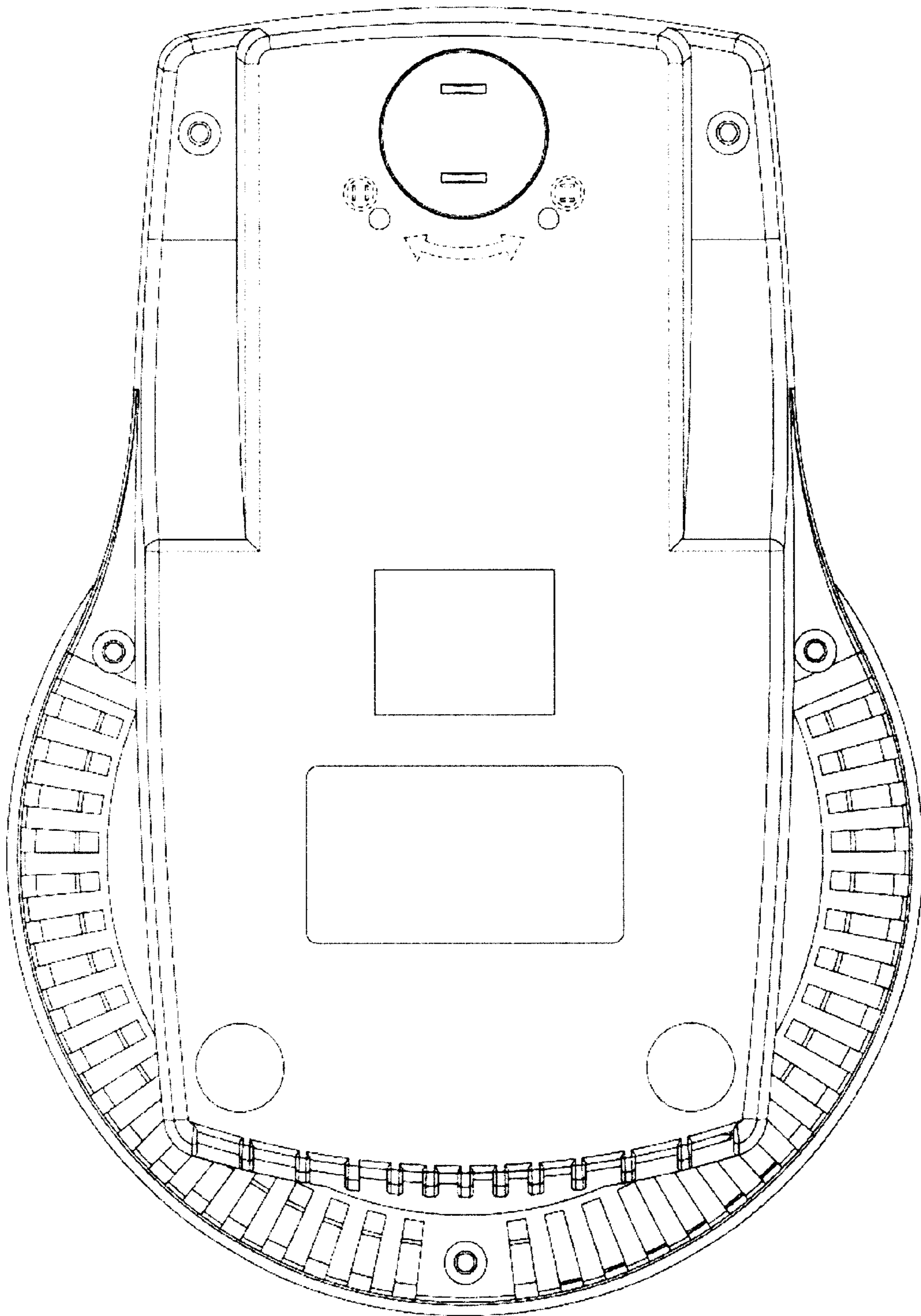

FIG. 4

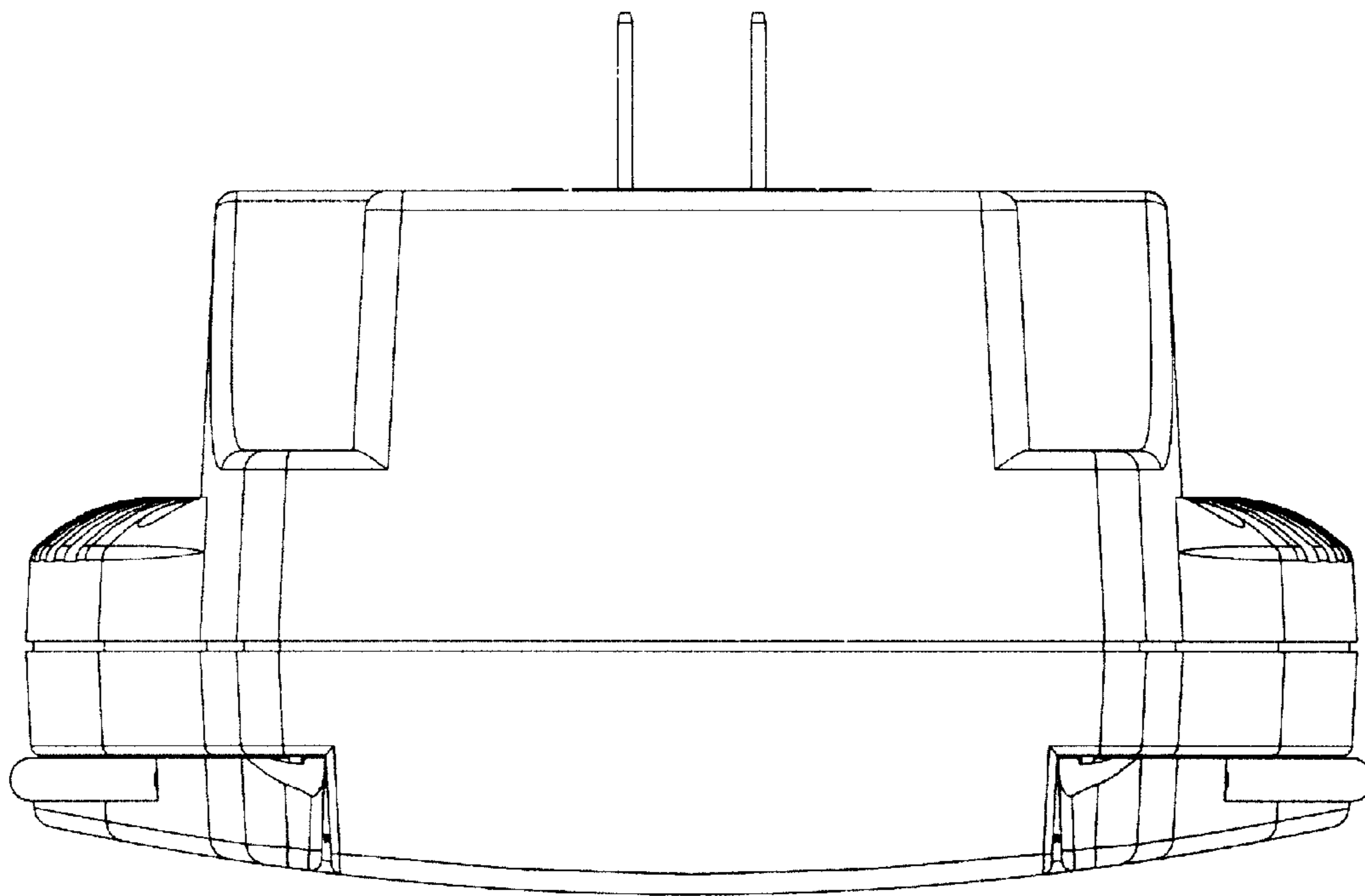

FIG. 5

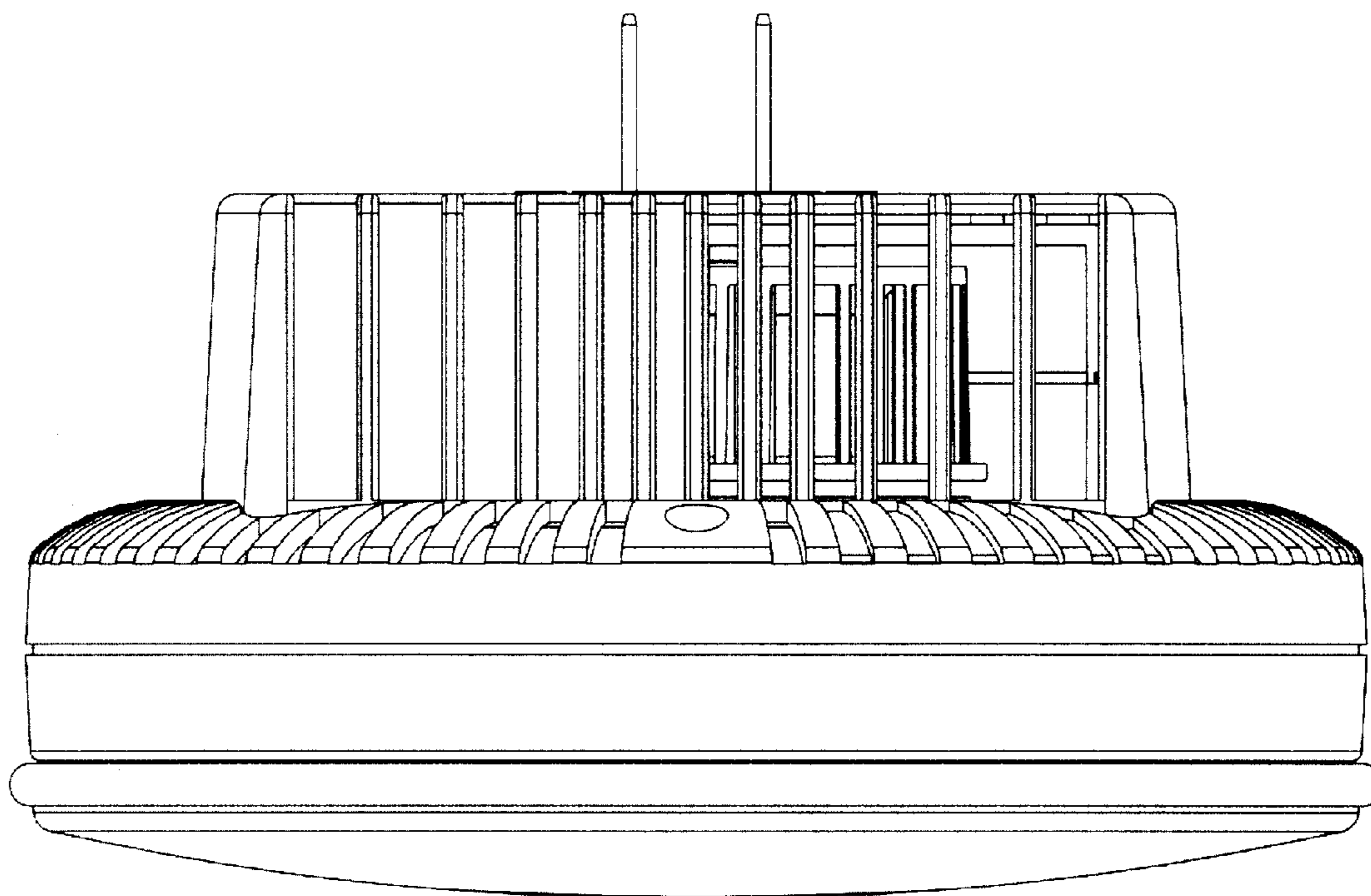

FIG. 6

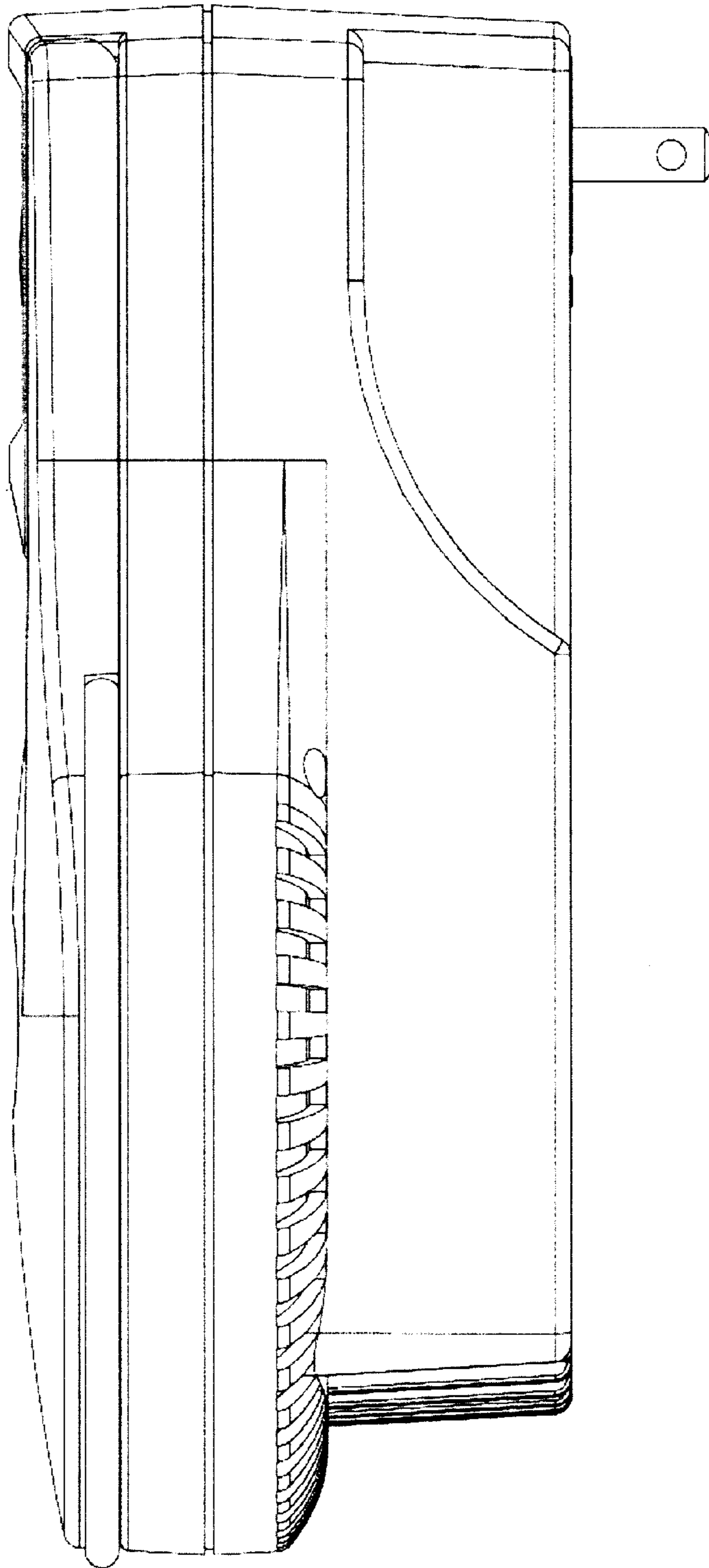

FIG. 7

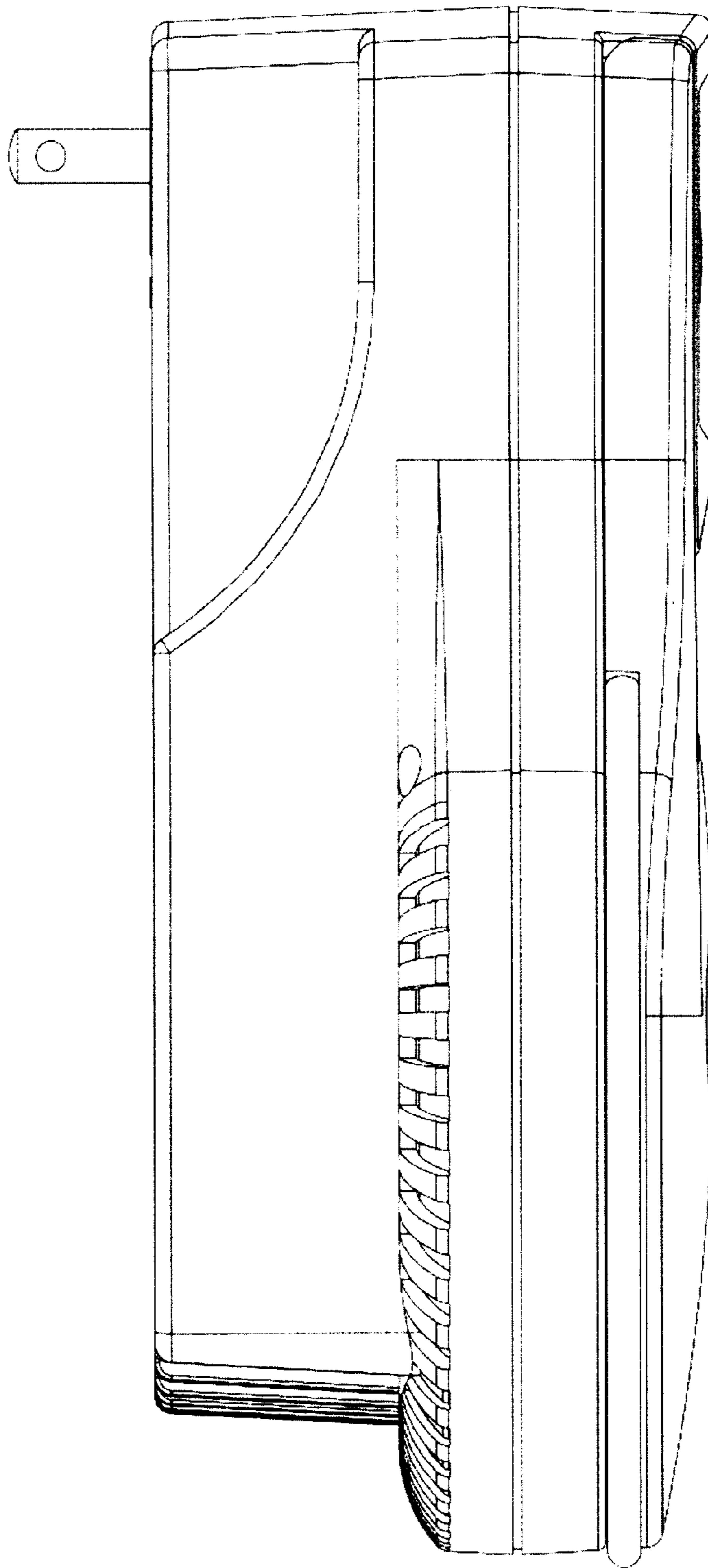

FIG. 8



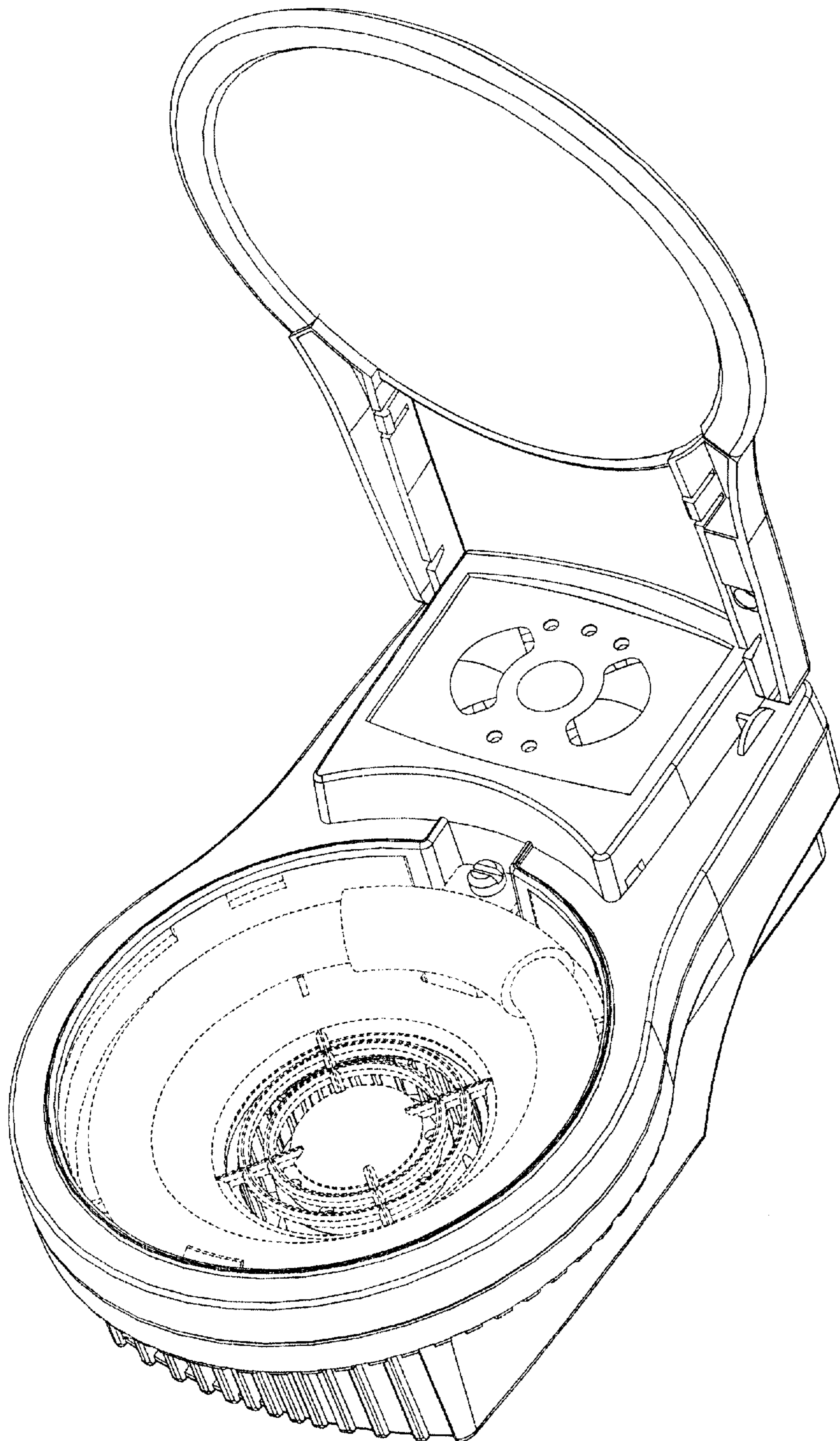

FIG. 9

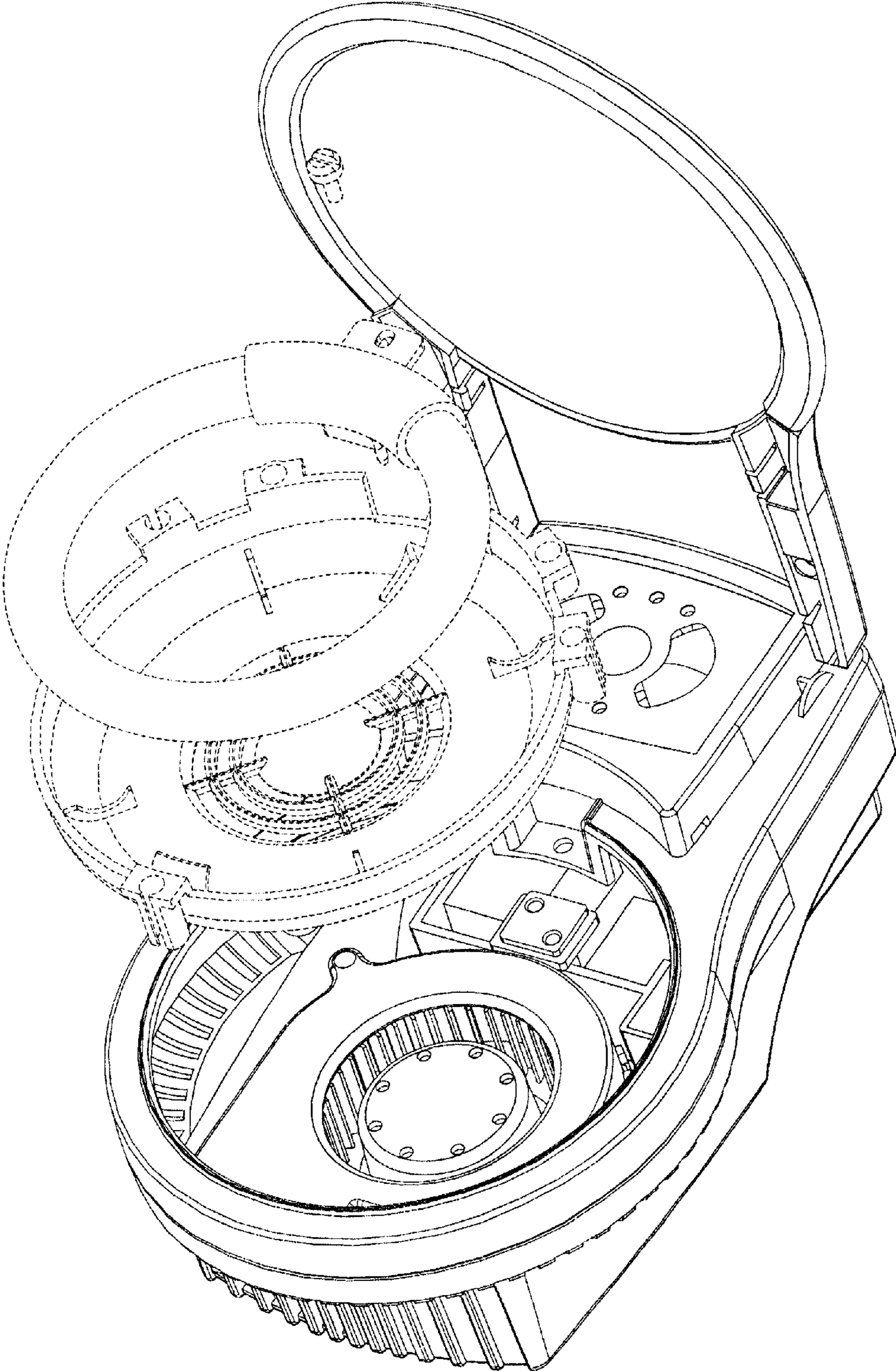

FIG. 10