



US00D528582S

(12) **United States Design Patent**
Flood

(10) **Patent No.:** **US D528,582 S**

(45) **Date of Patent:** **** Sep. 19, 2006**

(54) **SKATEBOARD SHAPED GUITAR**

(76) Inventor: **David Flood**, 1705 S. Maple,
Escondido, CA (US) 92025

(**) Term: **14 Years**

(21) Appl. No.: **29/218,334**

(22) Filed: **Dec. 1, 2004**

(51) **LOC (8) Cl.** **17-03**

(52) **U.S. Cl.** **D17/18**

(58) **Field of Classification Search** D17/14,
D17/15, 18-20; D21/261, 265; 84/267, 291,
84/293, 731, 743

See application file for complete search history.

(56) **References Cited**

U.S. PATENT DOCUMENTS

D246,065 S	*	10/1977	Saul	D21/765
4,616,550 A	*	10/1986	Lacroix et al.	84/267
4,770,079 A	*	9/1988	Mastroianni	84/291
D373,400 S	*	9/1996	Ogata et al.	D21/761
D375,114 S	*	10/1996	Excellente	D17/20
D410,024 S	*	5/1999	Eventoff et al.	D17/14

* cited by examiner

Primary Examiner—Adir Aronovich

(74) *Attorney, Agent, or Firm*—Bryan Cave LLP

(57) **CLAIM**

The ornamental design for a skateboard shaped guitar, as shown and described.

DESCRIPTION

FIG. 1 is a front perspective view of the skateboard shaped guitar showing my new design;

FIG. 2 is a top view of the skateboard shaped guitar showing my new design;

FIG. 3 is a back view of the skateboard shaped guitar showing my new design;

FIG. 4 is a front view of the skateboard shaped guitar showing my new design;

FIG. 5 is a right side view of the skateboard shaped guitar showing my new design; and,

FIG. 6 is a left side view of the skateboard shaped guitar showing my new design.

The portions of the guitar in broken lines are shown for illustrative purposes only and form no part of the claimed design.

1 Claim, 3 Drawing Sheets

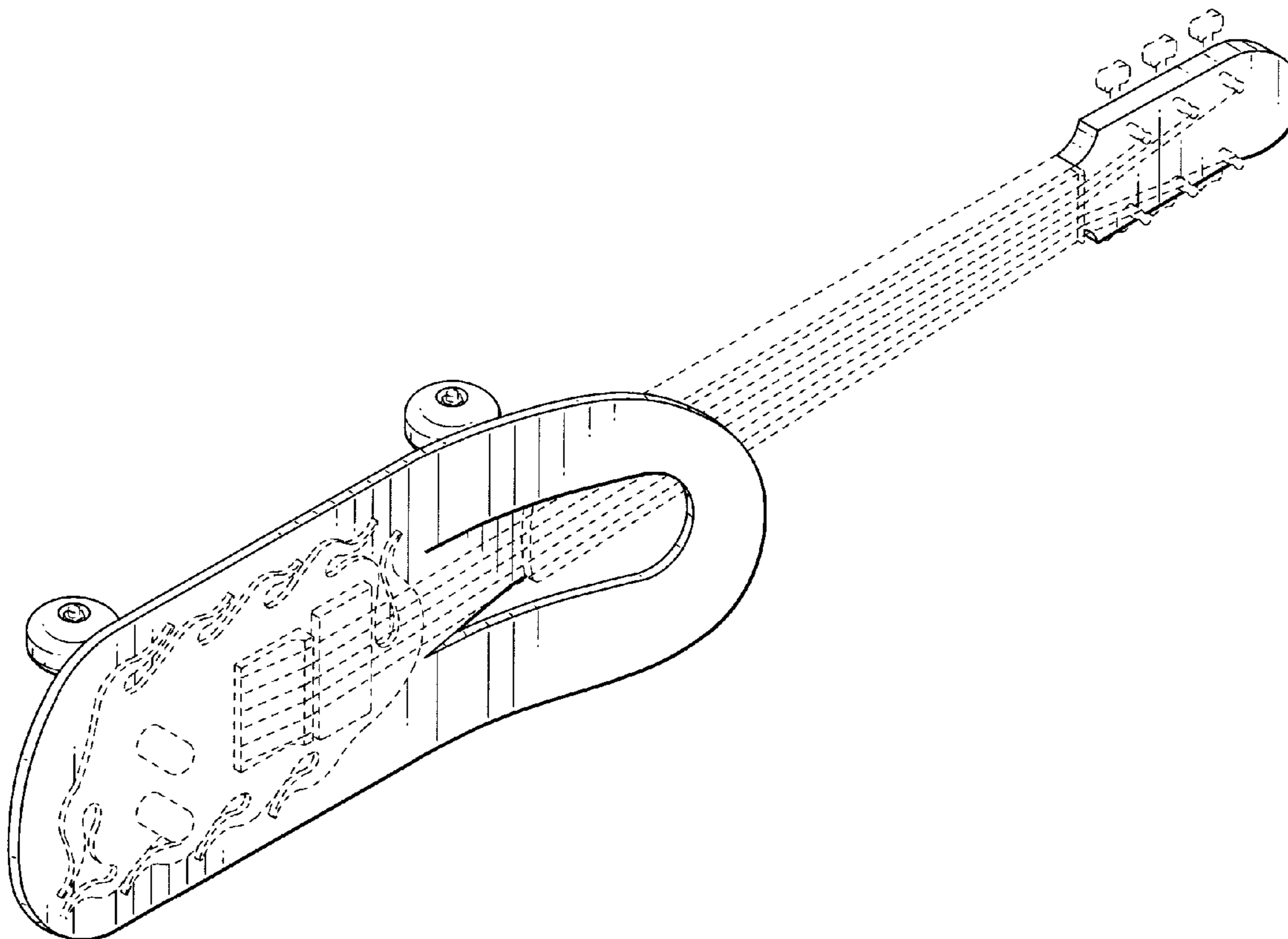

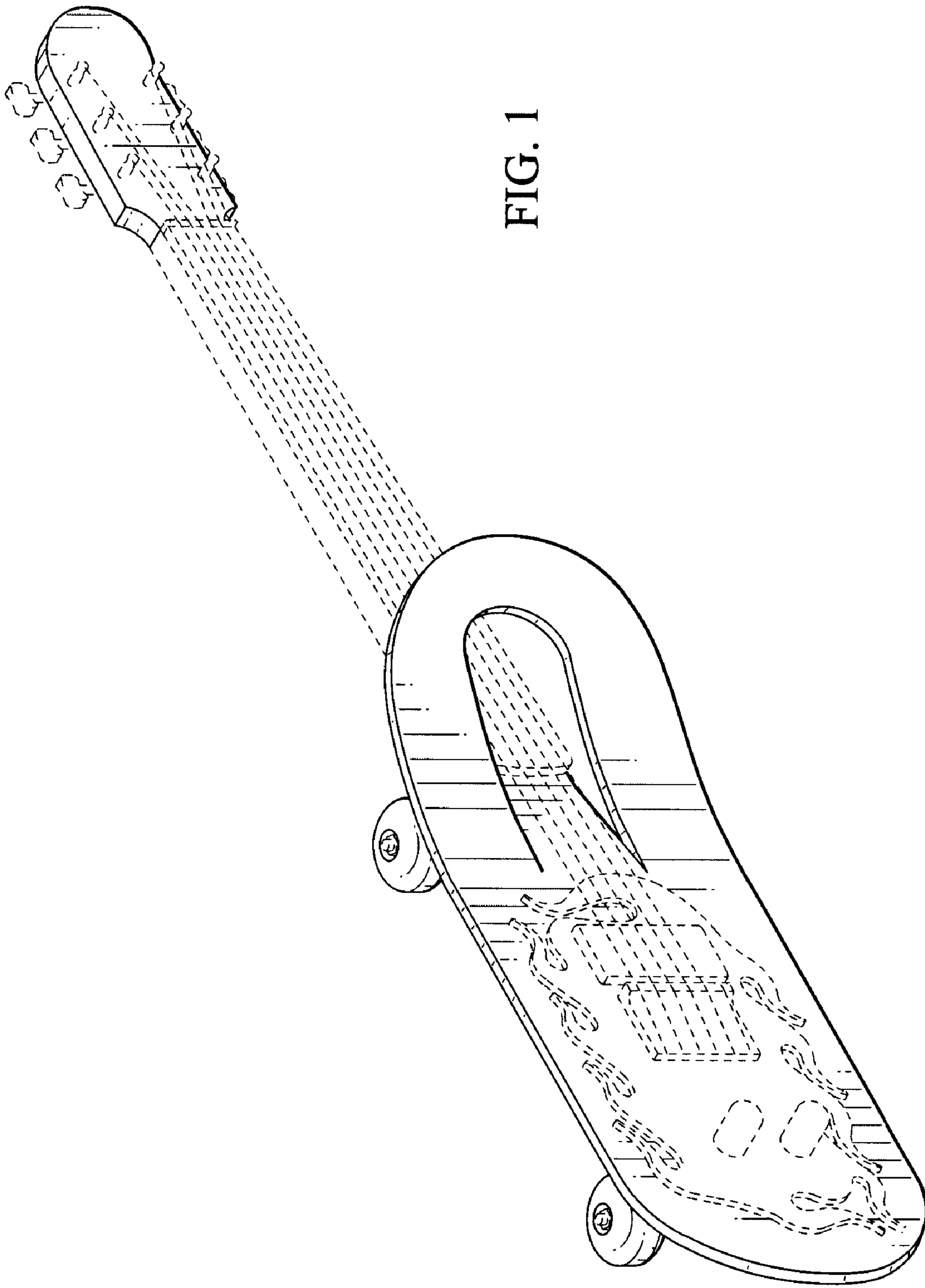

FIG. 1

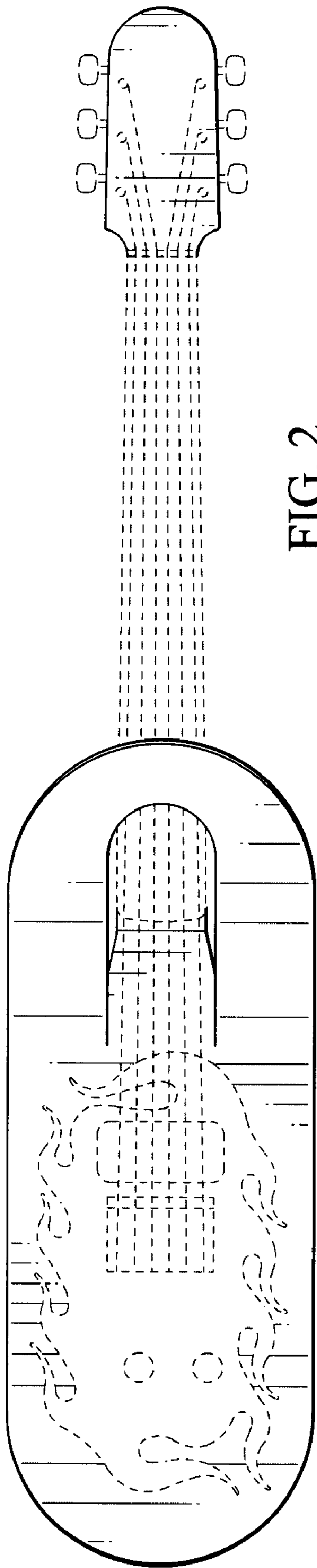

FIG. 2

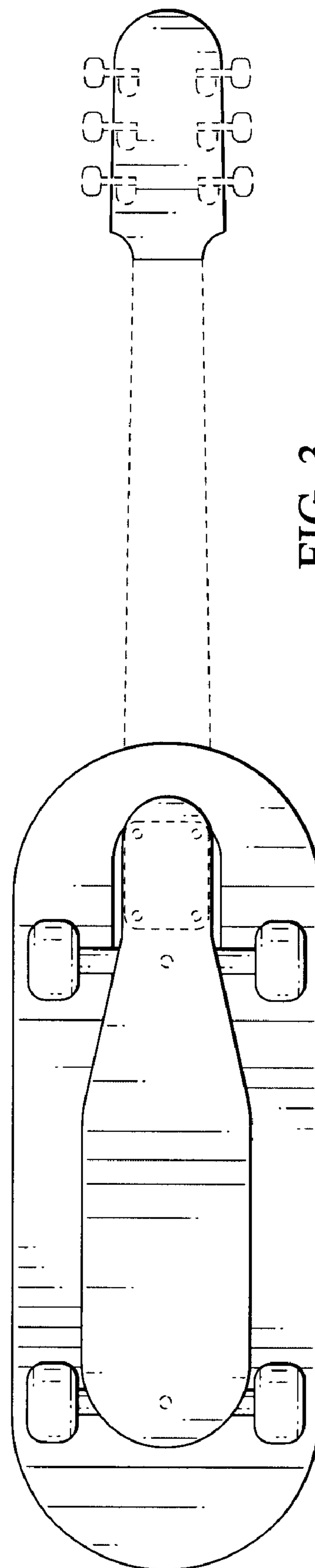

FIG. 3

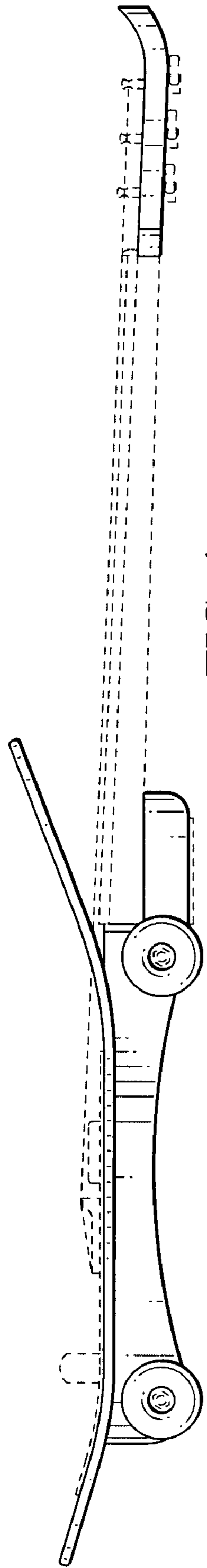

FIG. 4

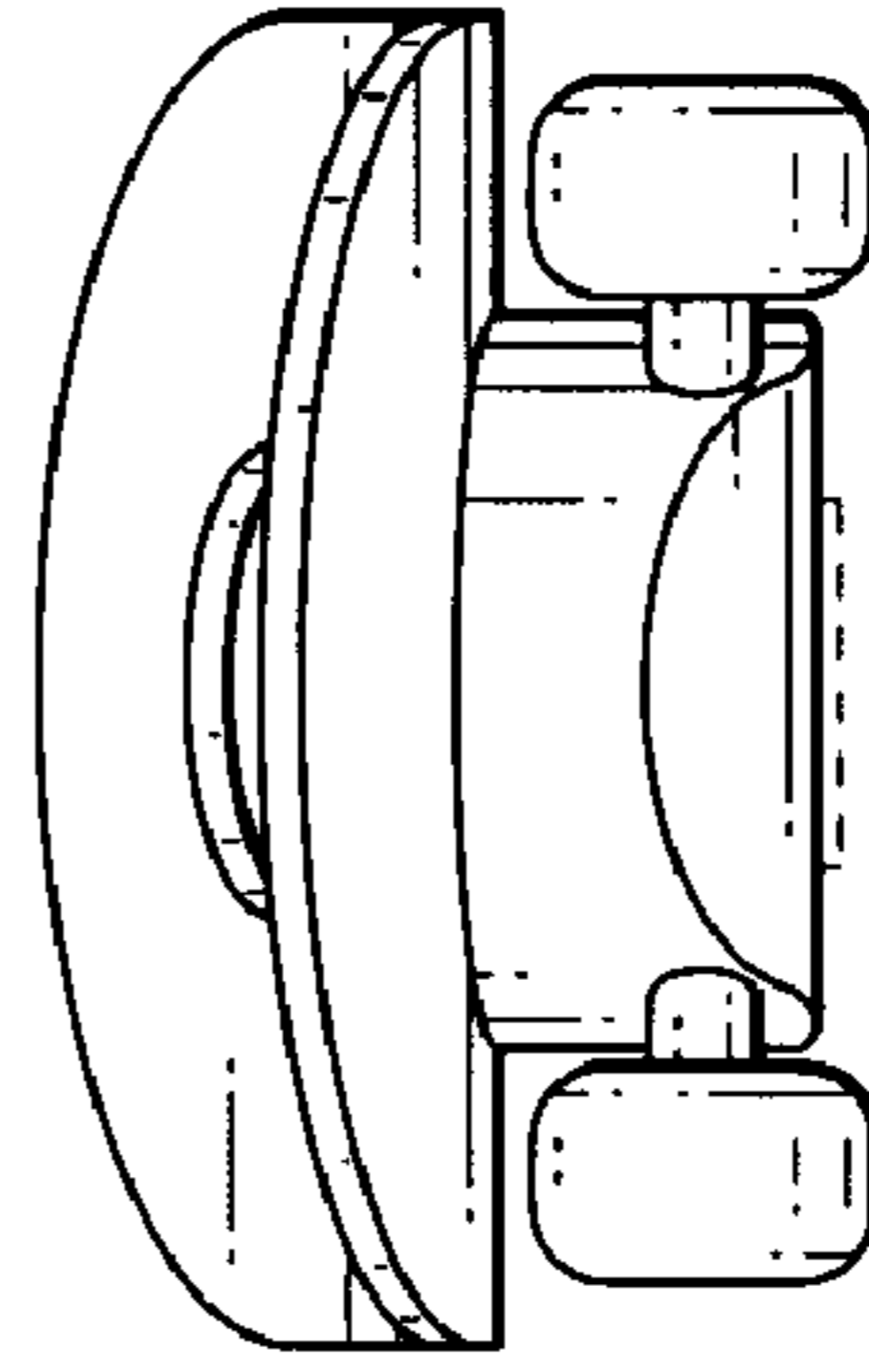

FIG. 6

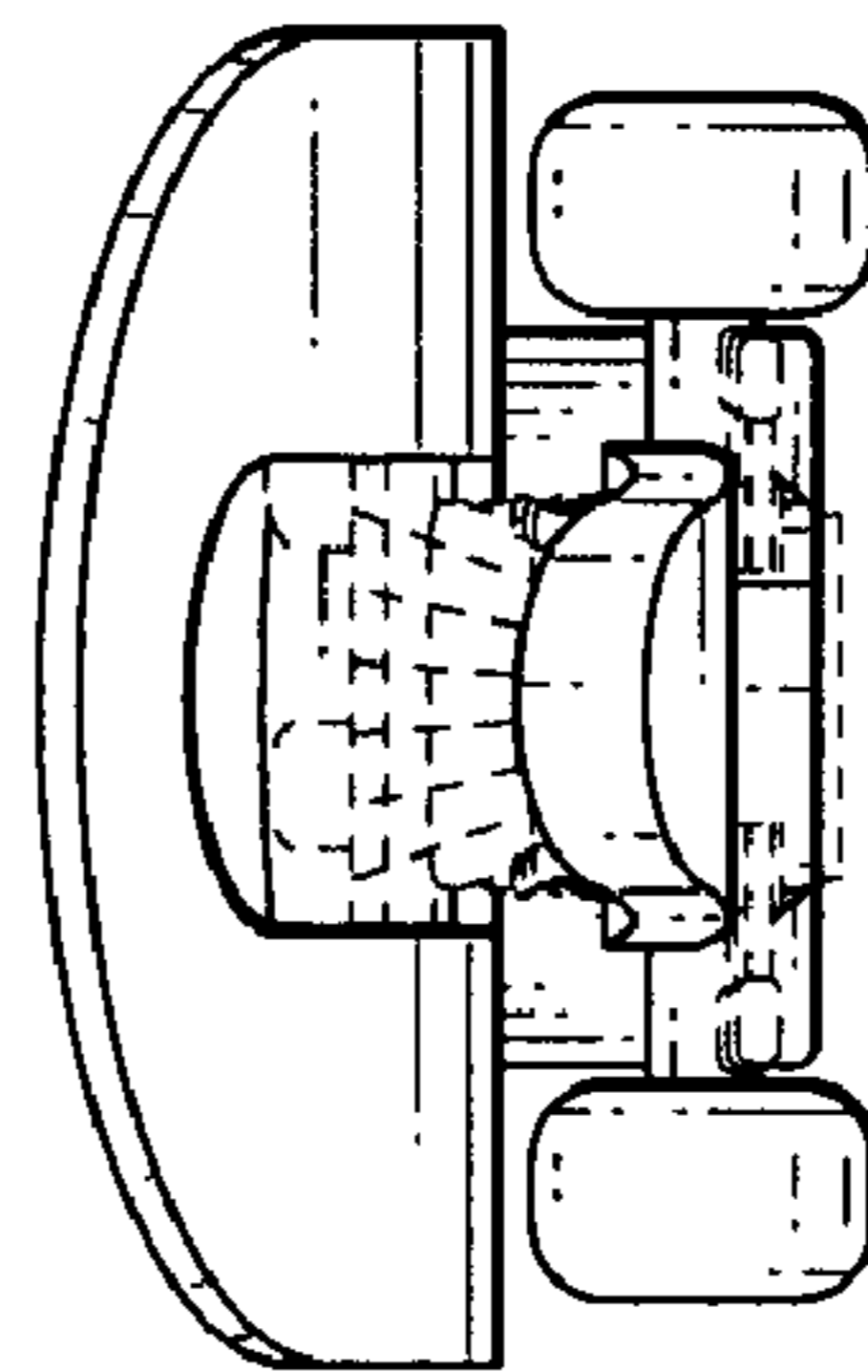

FIG. 5