



US00D528534S

(12) **United States Design Patent**
Farnsworth et al.

(10) **Patent No.:** **US D528,534 S**

(45) **Date of Patent:** **** Sep. 19, 2006**

(54) **AUDIO/VIDEO INTERCOM SYSTEM**

(75) Inventors: **Daniel A. Farnsworth**, Irvine, KY
(US); **Barry E. Royse**, Georgetown,
KY (US)

(73) Assignee: **Audio Authority Corporation**,
Lexington, KY (US)

(**) Term: **14 Years**

(21) Appl. No.: **29/214,151**

(22) Filed: **Sep. 27, 2004**

(51) **LOC (8) Cl.** **14-03**

(52) **U.S. Cl.** **D14/159**

(58) **Field of Classification Search** D14/162,
D14/159, 130, 158, 149, 142, 331, 229, 375,
D14/374; D13/177; 379/176, 167.14, 167.05,
379/156, 155; 248/123.11; 348/156; 455/575.2;
361/681

See application file for complete search history.

(56) **References Cited**

U.S. PATENT DOCUMENTS

D185,798 S	8/1959	Loge	
D210,026 S	1/1968	Kahn	
D211,092 S	5/1968	Kahn	
D224,117 S	* 7/1972	Genaro et al. D14/130
D247,561 S	* 3/1978	Peterson D14/227
D307,587 S	5/1990	Marcune	
D324,864 S	3/1992	Hector	
D327,480 S	6/1992	Soren	
D341,593 S	11/1993	Chang	
D349,284 S	8/1994	Robertus	

D354,952 S	*	1/1995	Rodd	D14/374
D356,791 S	*	3/1995	Desbarats	D14/130
D357,468 S	*	4/1995	Rodd	D14/375
D371,784 S		7/1996	Gertz		
D395,129 S	*	6/1998	Johnson	D99/28
D404,025 S	*	1/1999	Van Horne et al.	D14/331
6,015,120 A	*	1/2000	Sweere et al.	248/123.11
D475,985 S	*	6/2003	Huang et al.	D14/130
6,657,853 B1	*	12/2003	Oba et al.	361/681

OTHER PUBLICATIONS

Photograph of Old Intercom Unit used by Greyfield Industries, undated.

* cited by examiner

Primary Examiner—Cathron C. Brooks

Assistant Examiner—Austin Murphy

(74) *Attorney, Agent, or Firm*—King & Schickli, PLLC

(57) **CLAIM**

The ornamental design for an audio/video intercom system, as shown and described.

DESCRIPTION

FIG. 1 is a perspective view of the audio/video intercom system of the present invention;

FIG. 2 is a front elevational view thereof;

FIG. 3 is a right side elevational view thereof;

FIG. 4 is a rear elevational view thereof;

FIG. 5 is a left side elevational view thereof; and,

FIG. 6 is a top plan view thereof.

The broken lines in the Figures are for illustrative purposes only and form no part of the claimed design.

1 Claim, 6 Drawing Sheets

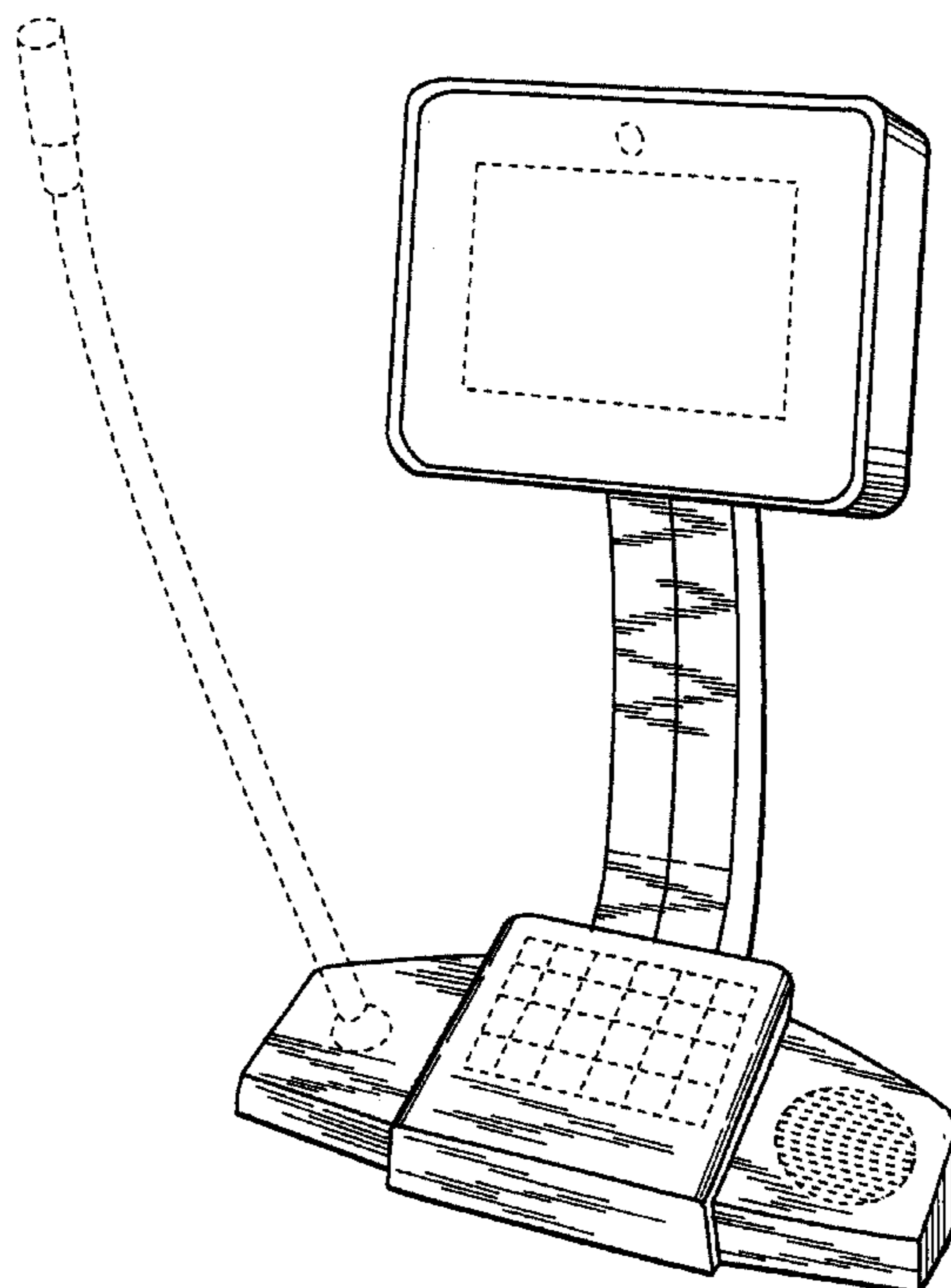

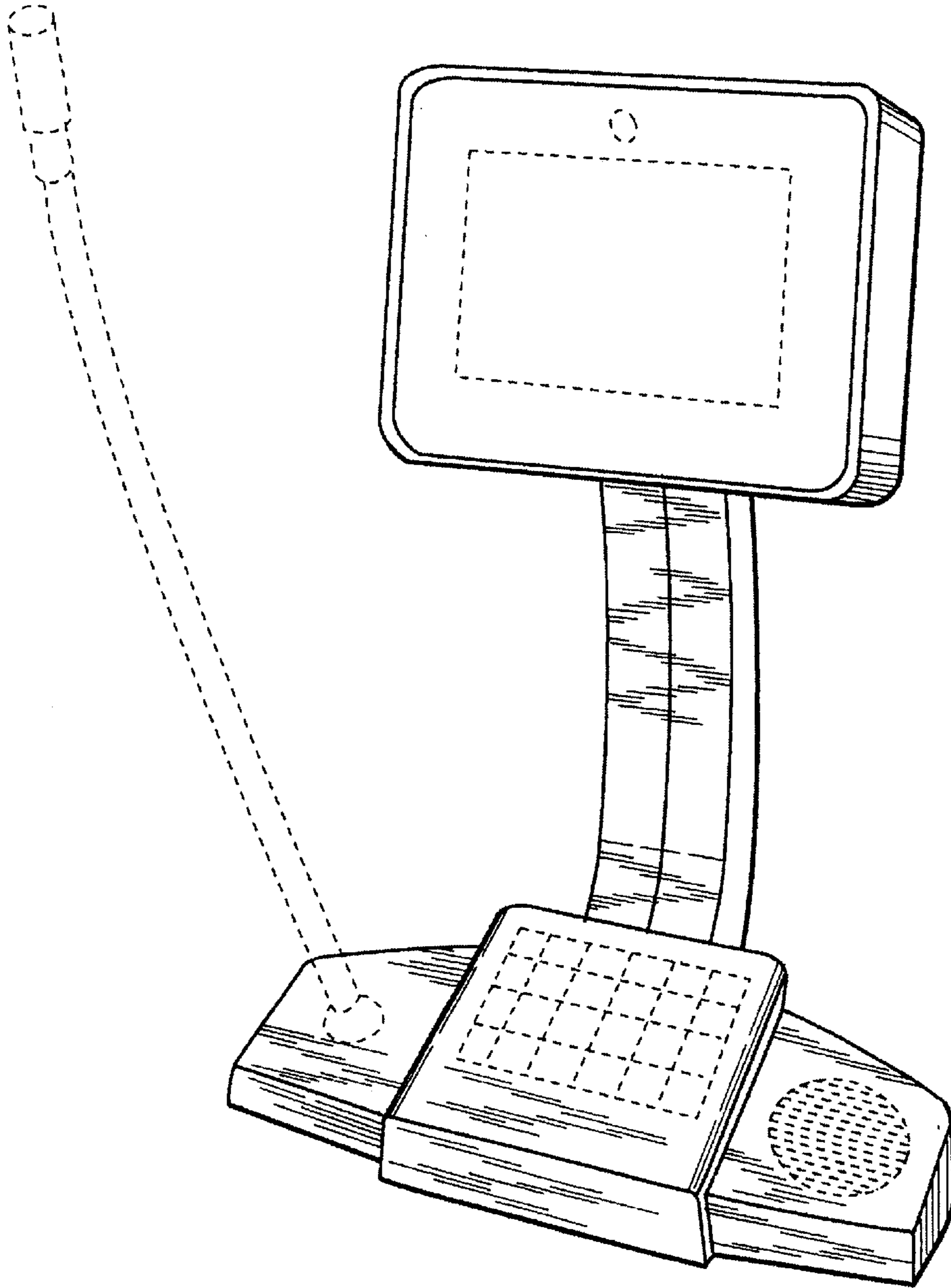

Fig. 1

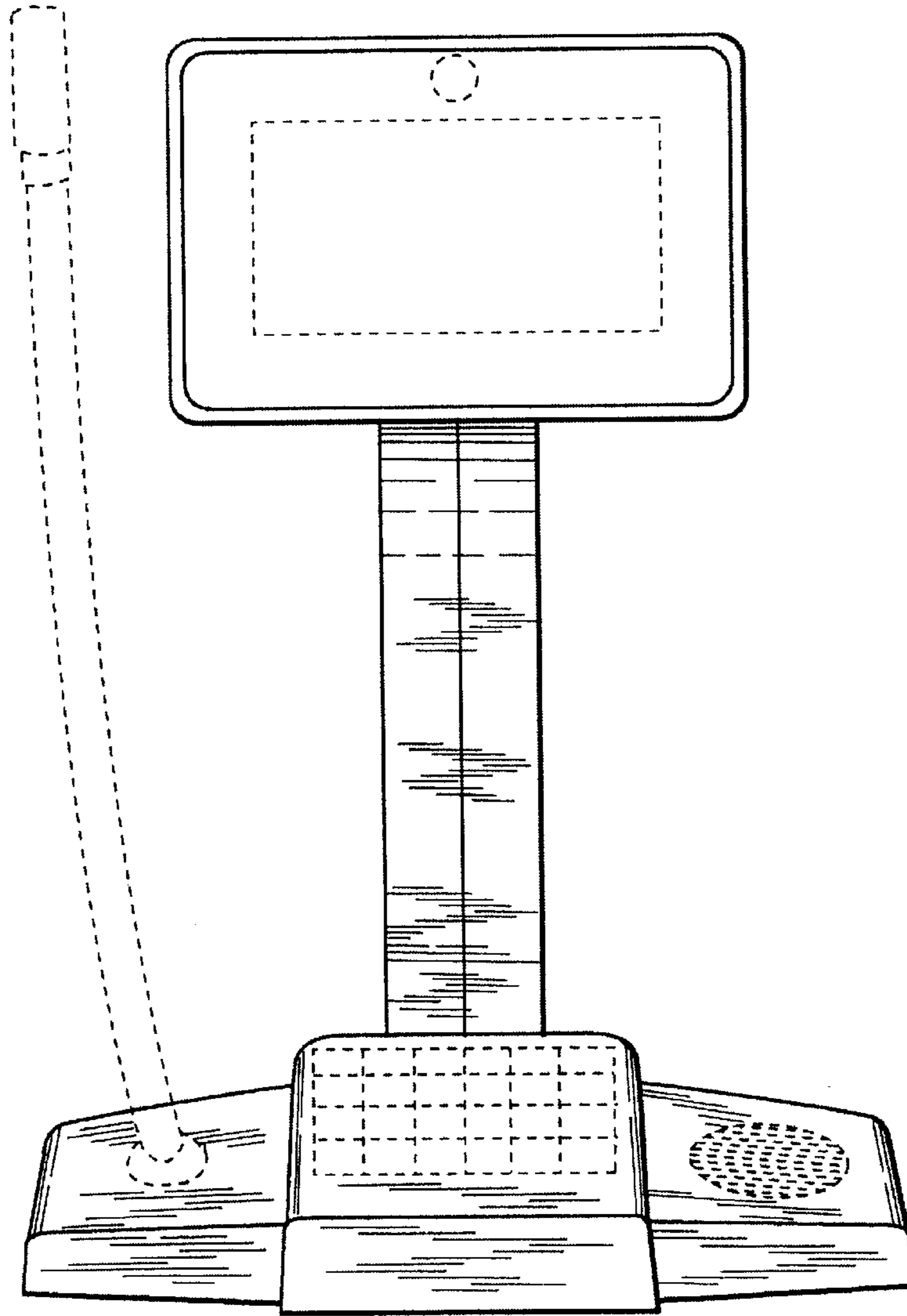

Fig. 2

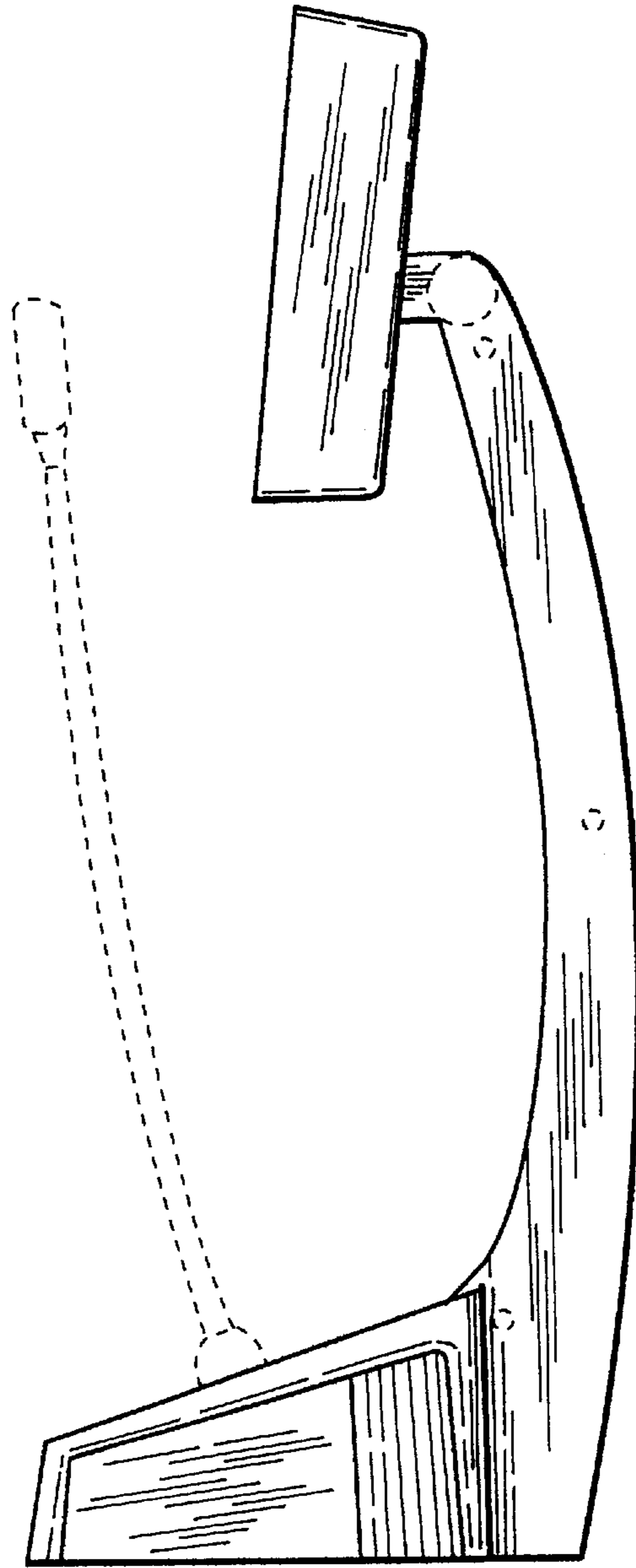

Fig. 3

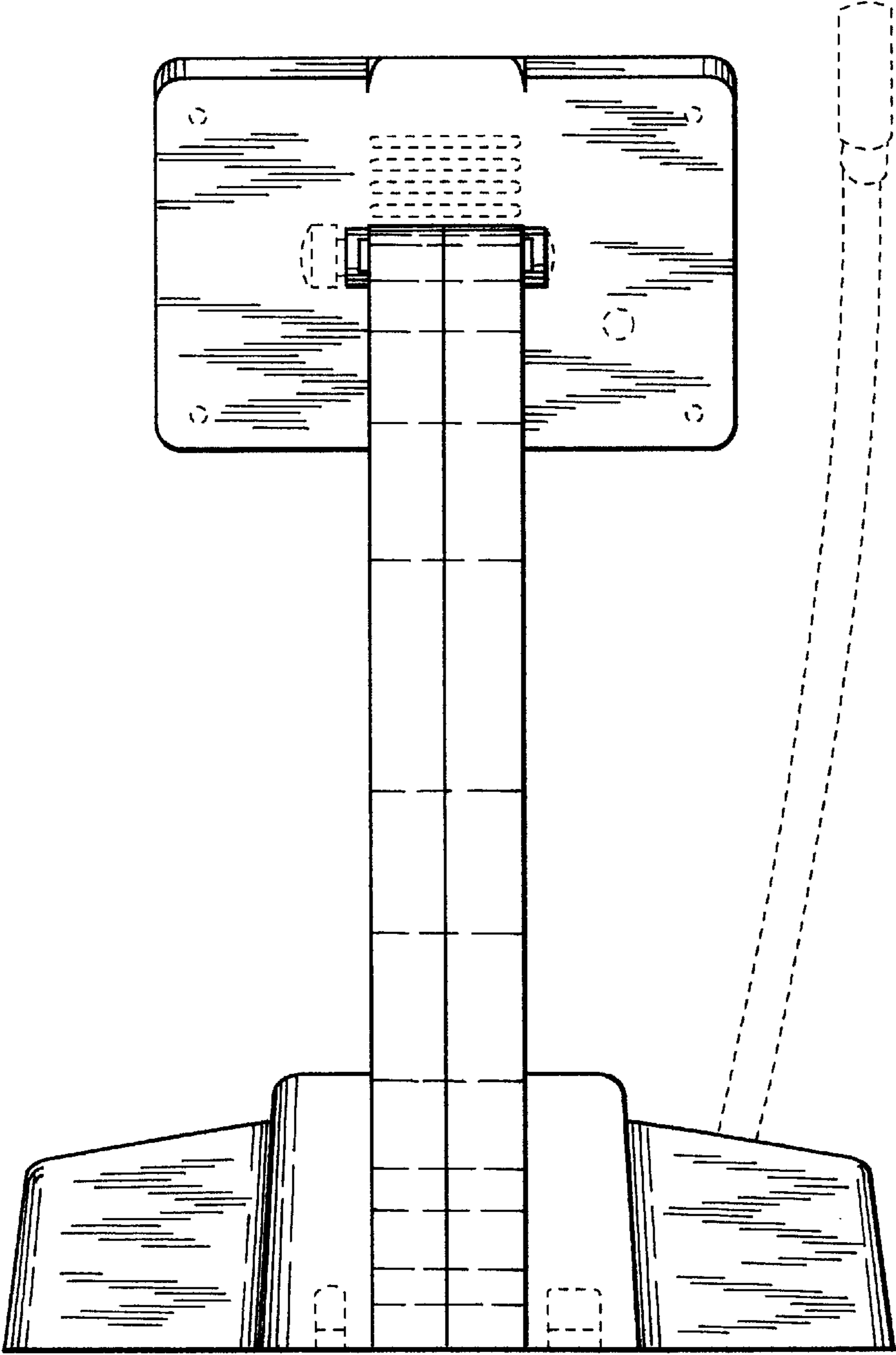

Fig. 4

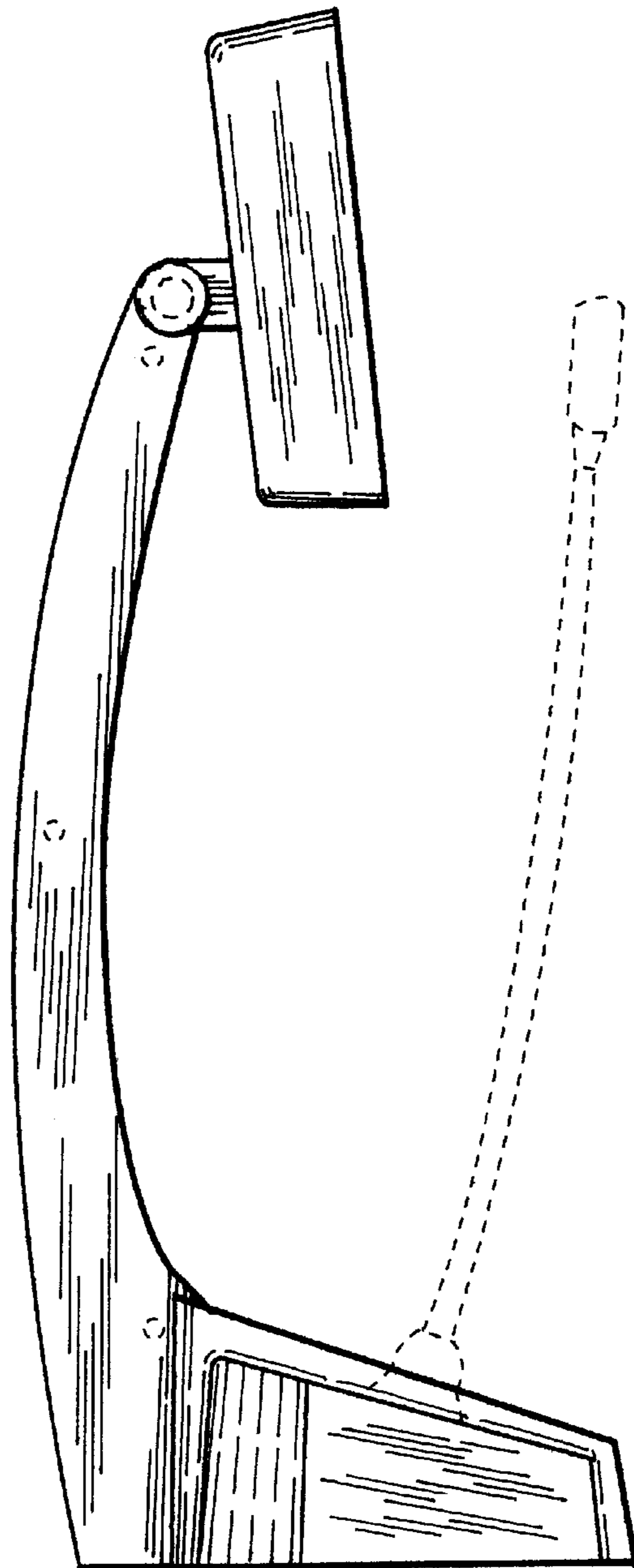

Fig. 5

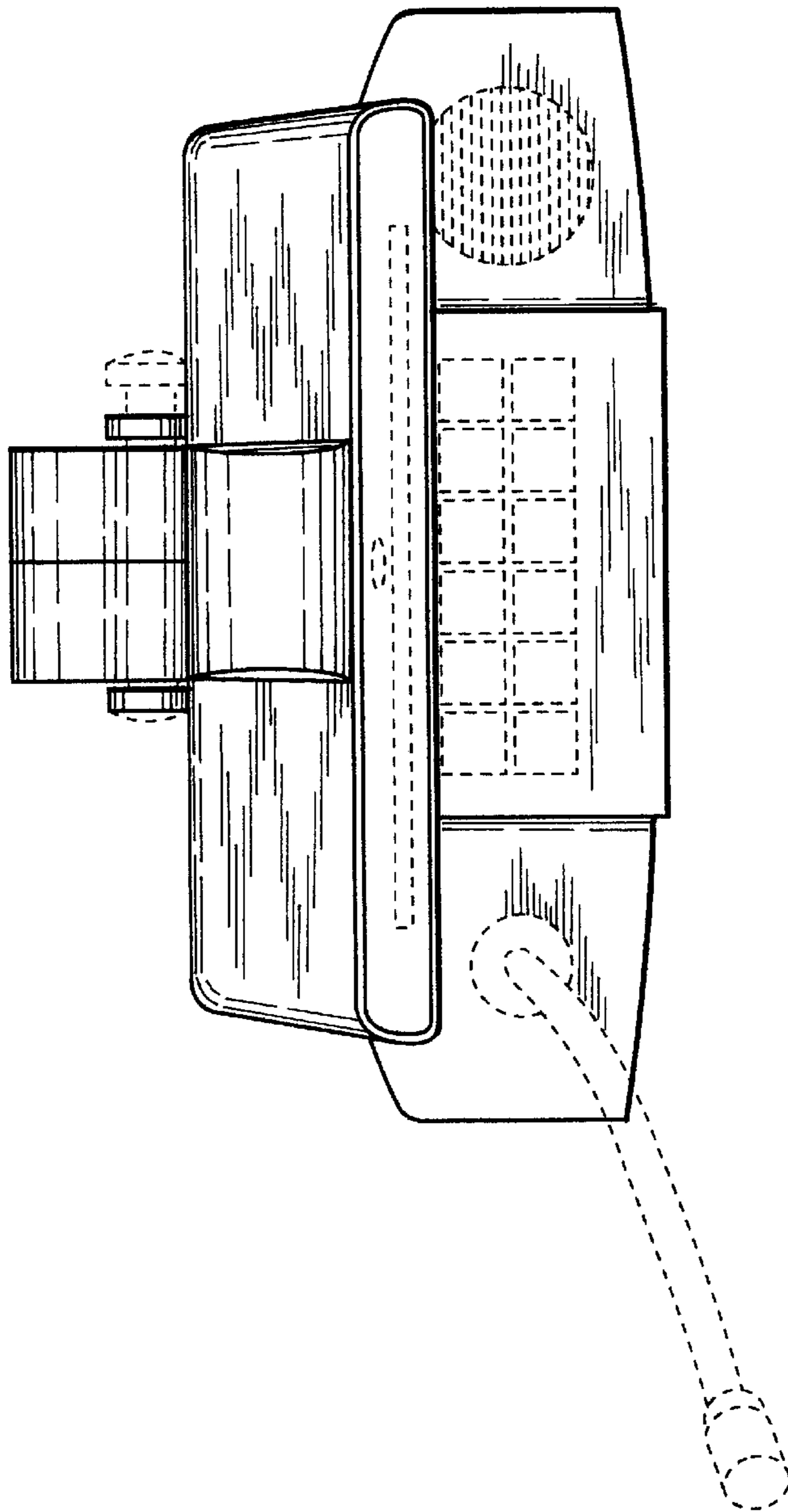

Fig. 6