



US00D528435S

(12) **United States Design Patent**  
**Keberlein**

(10) **Patent No.:** **US D528,435 S**

(45) **Date of Patent:** **\*\* Sep. 19, 2006**

(54) **DISPENSER FOR FOLDED PRODUCTS**

(75) **Inventor:** **Gerald J. Keberlein**, Hortonville, WI  
(US)

(73) **Assignee:** **Trinova Design, LLC**, Appleton, WI  
(US)

(\*\*) **Term:** **14 Years**

(21) **Appl. No.:** **29/231,160**

(22) **Filed:** **Jun. 1, 2005**

(51) **LOC (8) Cl.** ..... **09-03**

(52) **U.S. Cl.** ..... **D9/734**

(58) **Field of Classification Search** ..... D9/414–416,  
D9/418, 730, 430–433, 733, 734; D6/515,  
D6/518, 522; 206/806, 499, 494, 762, 45.26,  
206/438; 221/45, 305, 309, 33, 311; 229/122.1,  
229/122.2, 158, 164, 104, 122, 100  
See application file for complete search history.

(56) **References Cited**

**U.S. PATENT DOCUMENTS**

846,683	A	3/1907	Moore et al.	
1,217,682	A *	2/1917	Baldwin	221/63
1,683,641	A	9/1928	Whitney	
2,701,089	A *	2/1955	Fischer	206/775
3,002,651	A	10/1961	Gauld	221/34
3,239,097	A *	3/1966	Bates et al.	221/48
3,568,883	A	3/1971	Reynolds	221/305
D257,830	S *	1/1981	Card	D9/432
D259,024	S *	4/1981	Roccaforte et al.	D9/432
D277,169	S *	1/1985	Ito et al.	D9/734
D321,134	S *	10/1991	Toinet	D9/415

D321,647	S *	11/1991	Oldorf	D9/734
D332,214	S *	1/1993	Mulder et al.	D9/733
D333,781	S *	3/1993	Kobel	D9/734
D411,104	S *	6/1999	Simile-Gravina et al.	D9/416
D446,451	S *	8/2001	Roemer et al.	D9/433
6,415,949	B1 *	7/2002	Tramontina	221/45
6,575,329	B1	6/2003	Clark	221/45
D484,047	S *	12/2003	Hirschey	D9/433
D492,594	S *	7/2004	Nash	D9/415
6,866,185	B1	3/2005	Harrelson	229/104
2004/0124207	A1	7/2004	Tramontina et al.	221/305

\* cited by examiner

*Primary Examiner*—Stella Reid

*Assistant Examiner*—Mark Goodwin

(74) *Attorney, Agent, or Firm*—Whyte Hirschboeck Dudek  
SC

(57) **CLAIM**

The ornamental design for a dispenser for folded products,  
as shown and described.

**DESCRIPTION**

FIG. 1 is a perspective view of a dispenser for folded products illustrating my new design;  
FIG. 2 is a top plan view thereof;  
FIG. 3 is a front view thereof;  
FIG. 4 is a right side view thereof;  
FIG. 5 is a left side view thereof;  
FIG. 6 is a bottom plan view thereof; and,  
FIG. 7 is a rear view thereof.  
The broken line showing in FIGS. 1 and 6 is for illustrative purposes only and forms no part of the claimed design.

**1 Claim, 4 Drawing Sheets**

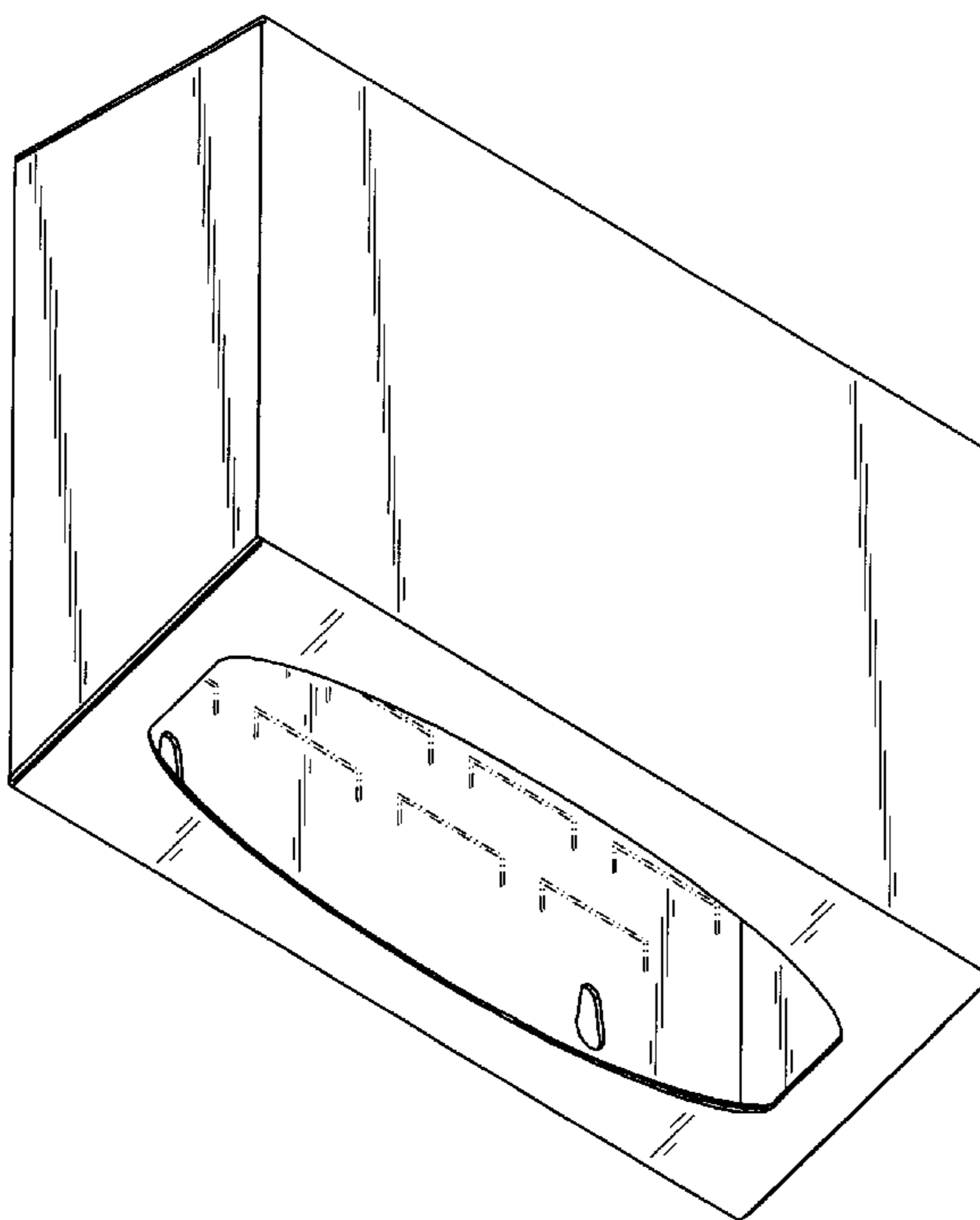

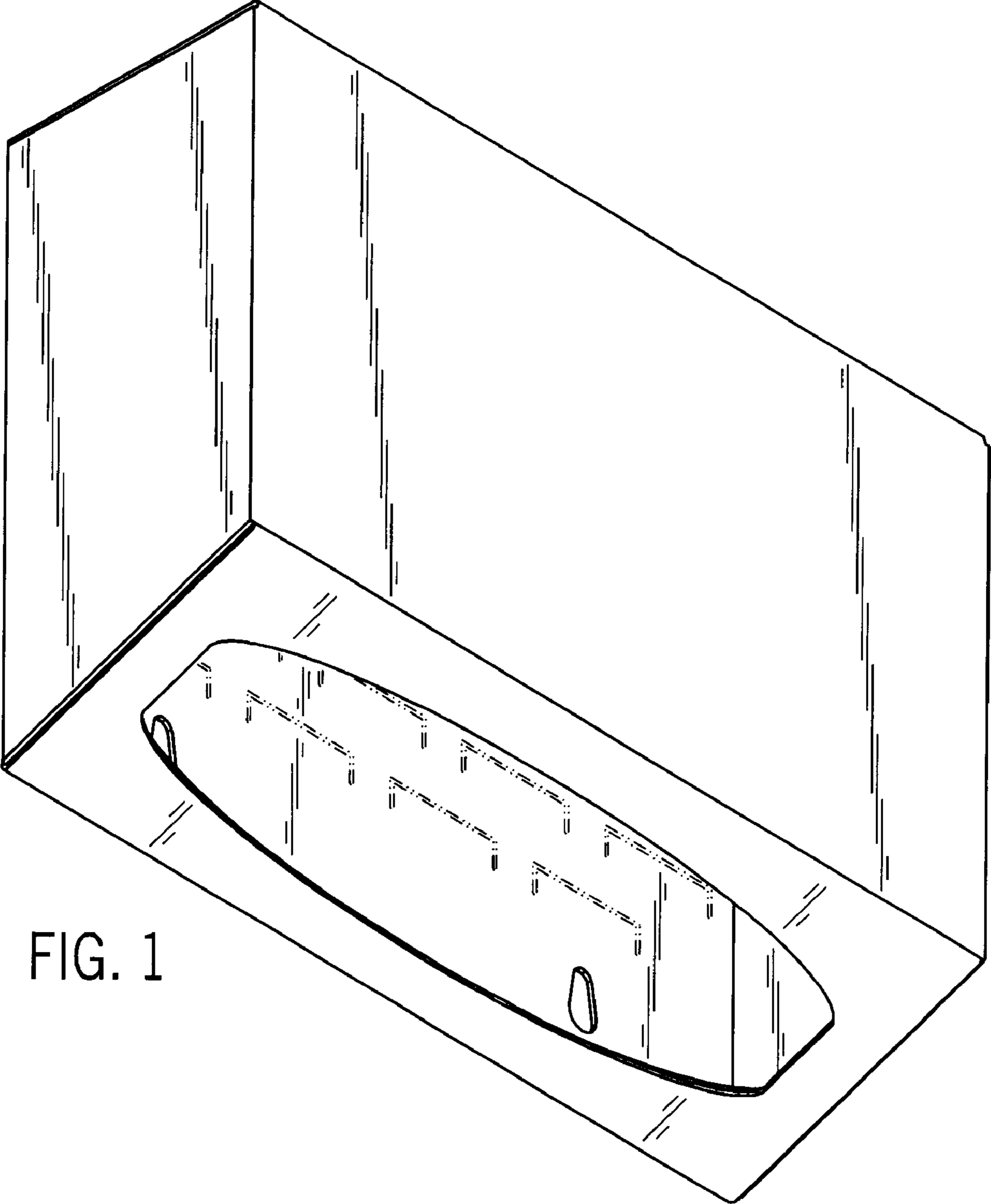

FIG. 1

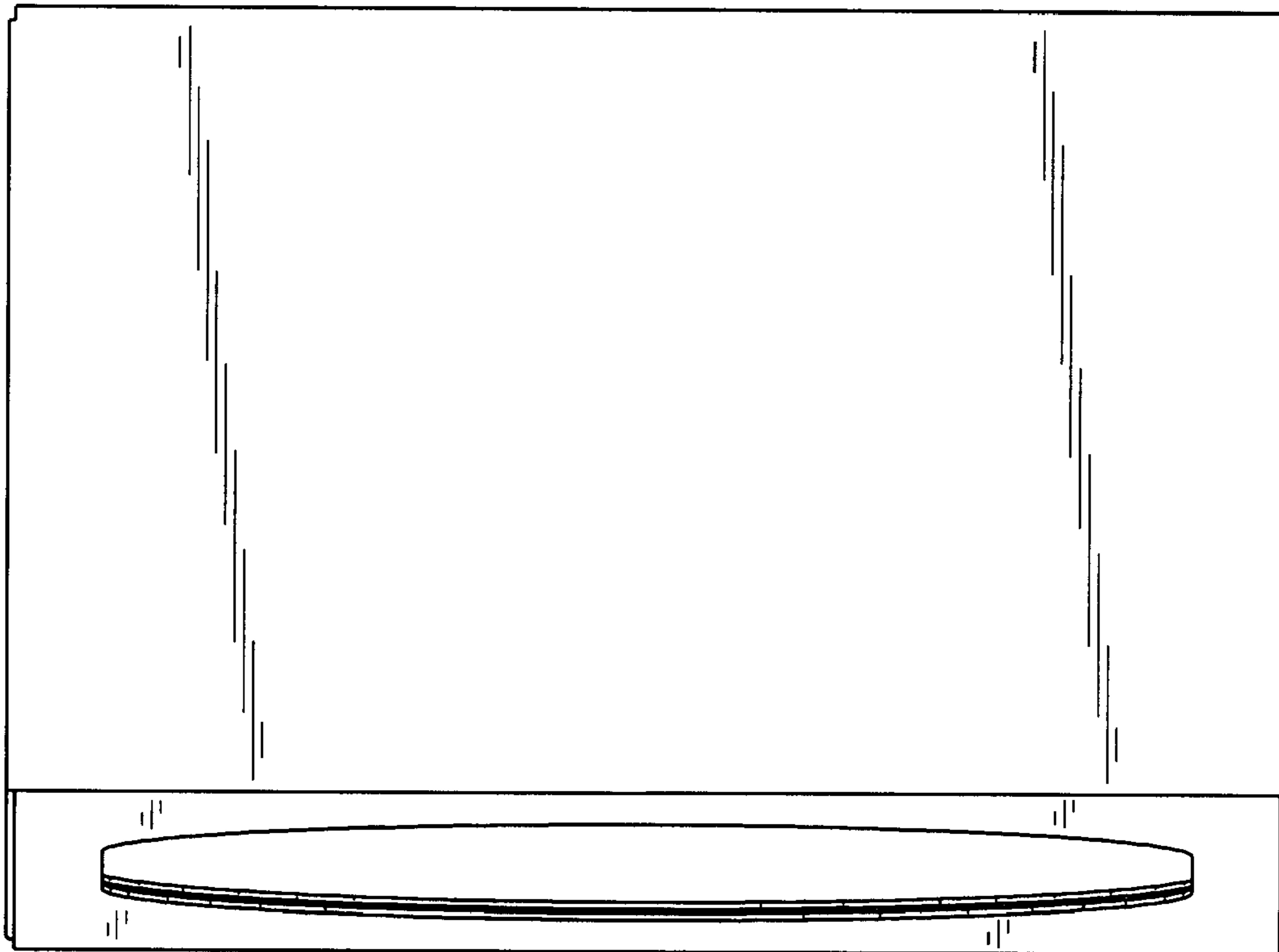

FIG. 2

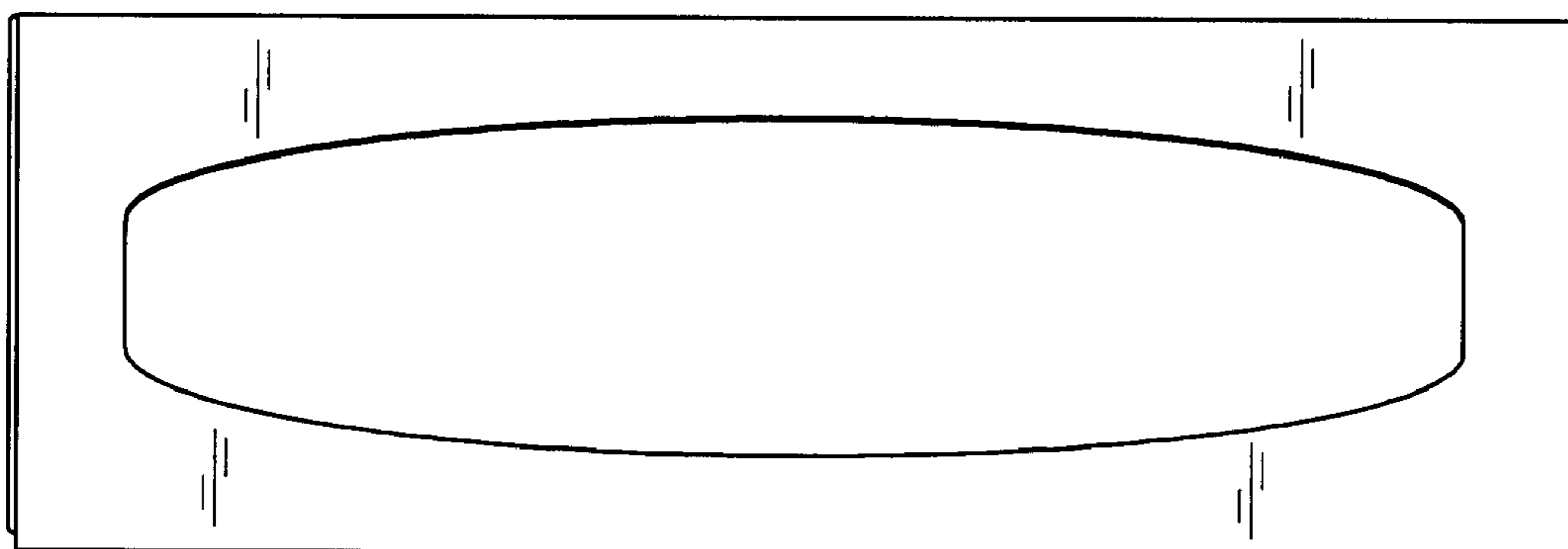

FIG. 3

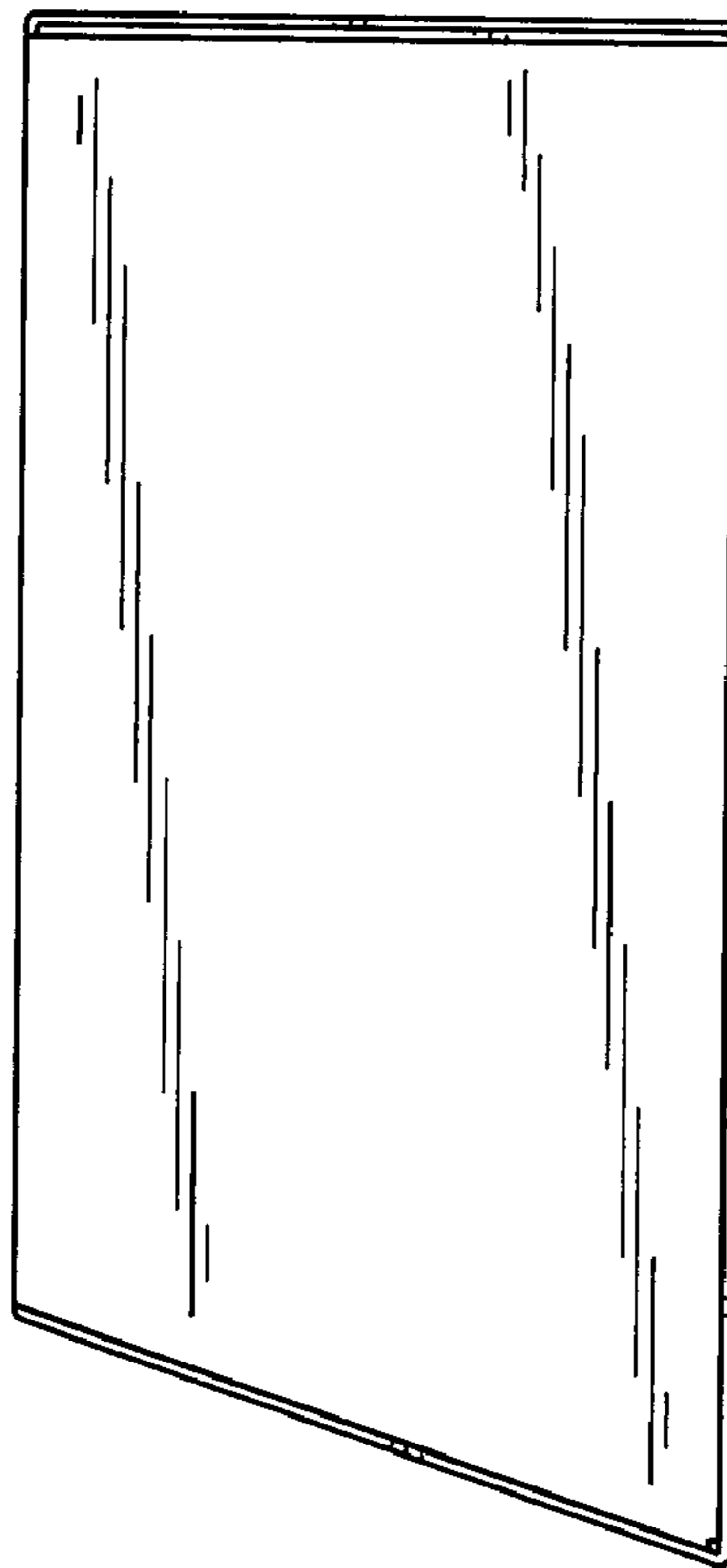

FIG. 4

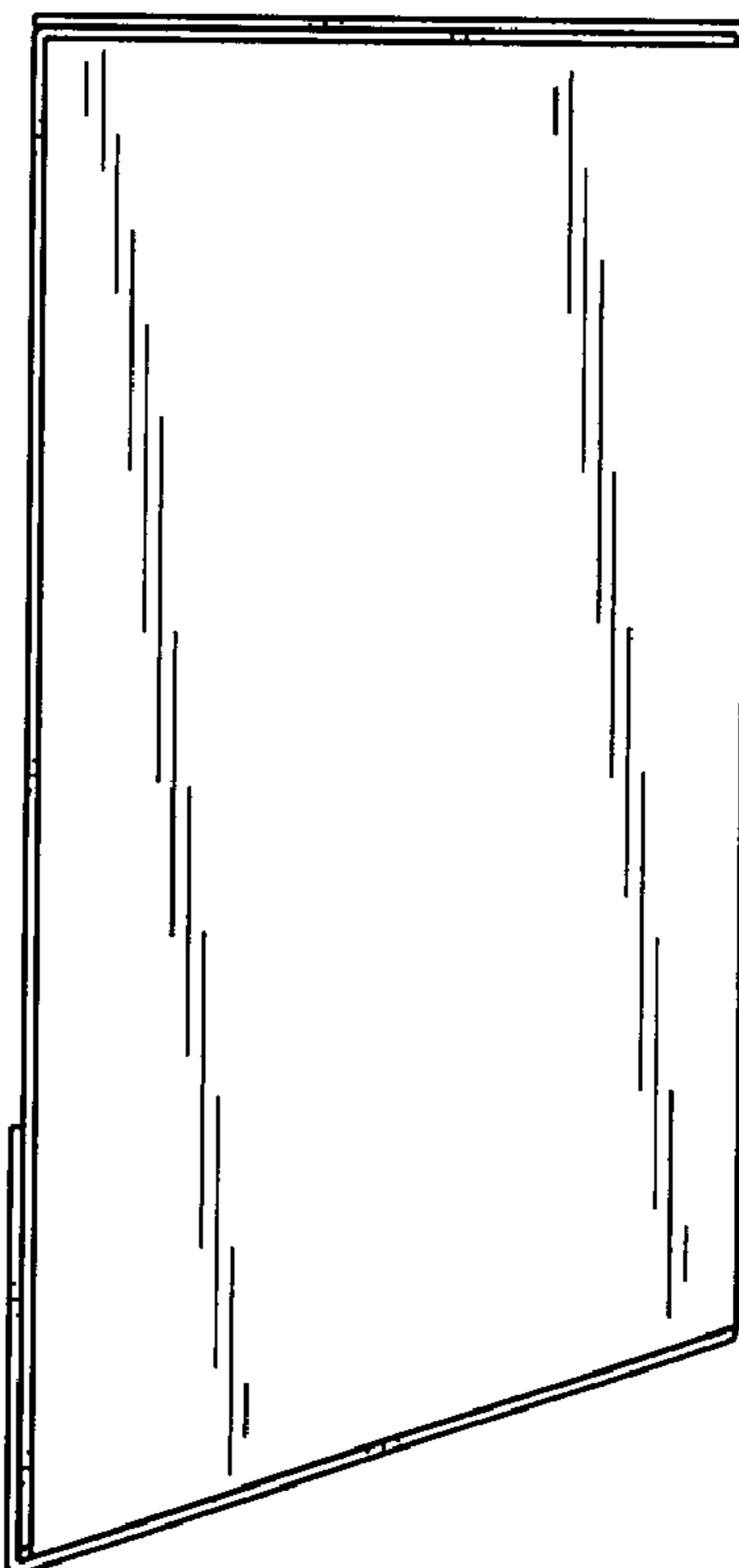

FIG. 5

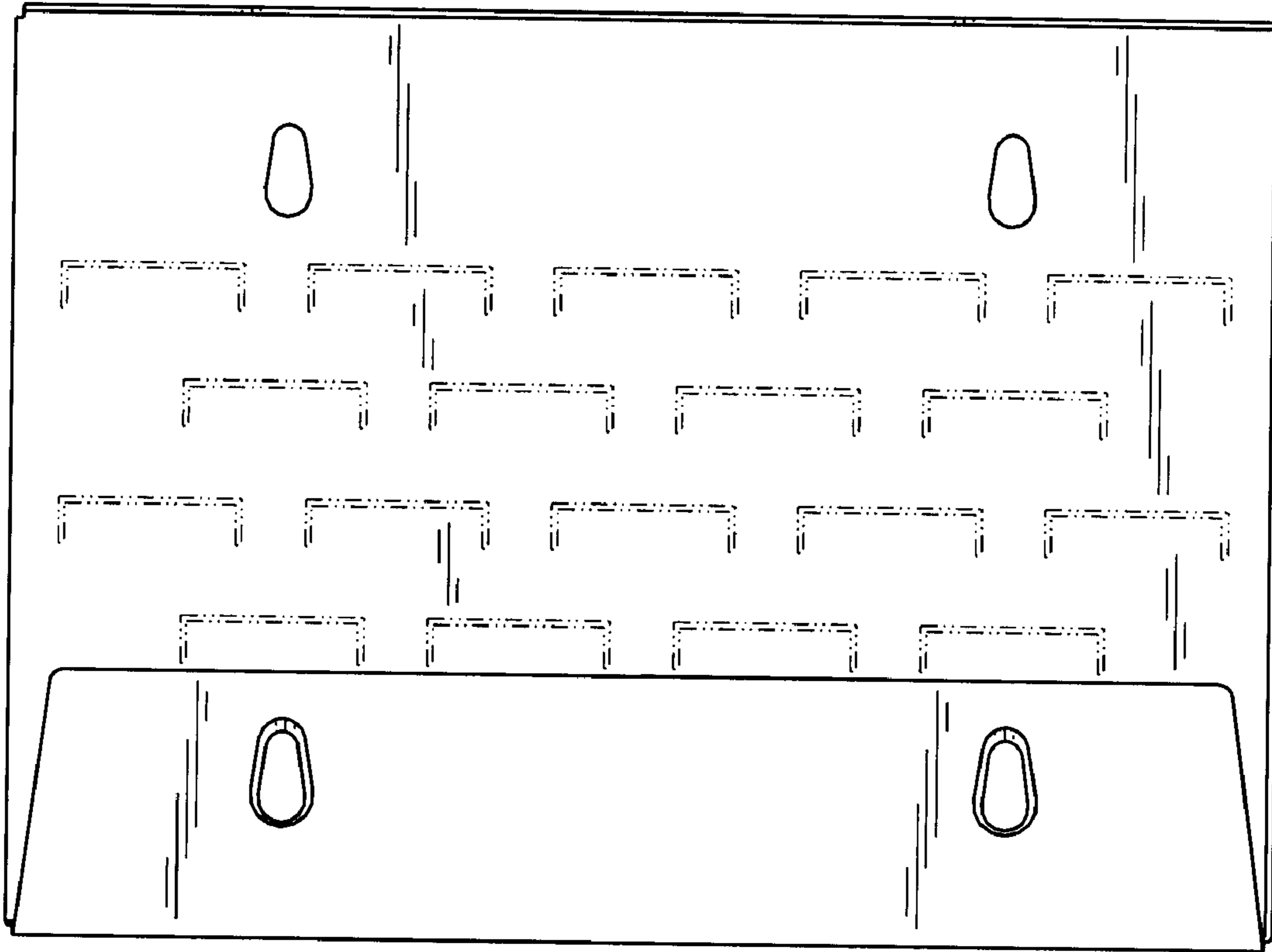

FIG. 6

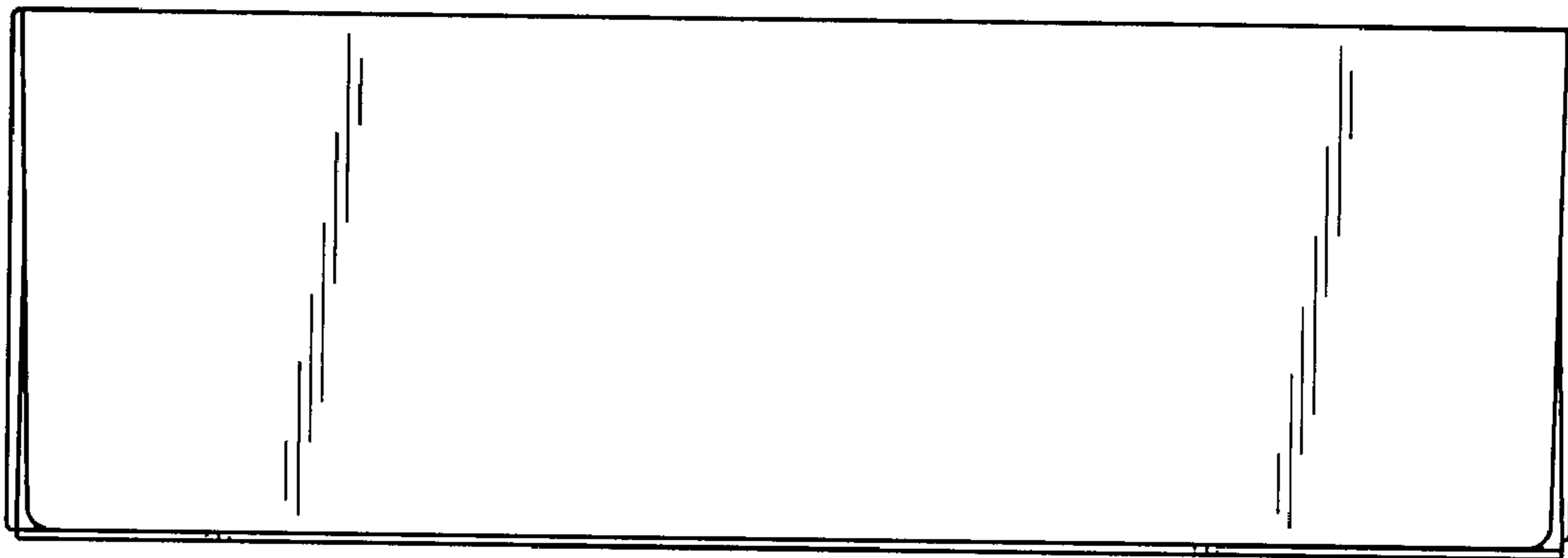

FIG. 7