

US00D528370S

(12) **United States Design Patent**
Cooper

(10) **Patent No.:** **US D528,370 S**

(45) **Date of Patent:** **** Sep. 19, 2006**

(54) **COLLAPSIBLE AND FOLDABLE ROLLING COOLER**

D432,871 S * 10/2000 Nottingham et al. D7/607
6,182,981 B1 * 2/2001 Kuo 280/47.17

(75) Inventor: **Sandra Cooper**, Milford, CT (US)

* cited by examiner

(73) Assignee: **Garden Meadow, Inc.**, Milford, CT (US)

Primary Examiner—Terry A. Wallace

(74) *Attorney, Agent, or Firm*—Melvin I. Stoltz

(**) Term: **14 Years**

(57) **CLAIM**

The ornamental design for a collapsible and foldable rolling cooler, as shown and described.

(21) Appl. No.: **29/229,557**

(22) Filed: **May 9, 2005**

DESCRIPTION

(51) **LOC (8) Cl.** **07-01**

(52) **U.S. Cl.** **D7/607; D3/279**

(58) **Field of Classification Search** D7/603–608;
D3/273, 274, 276, 279, 289, 301, 303; 62/371,
62/372, 239, 530, 457.1–457.8; 220/915.1,
220/915.2, 592.03, 592.09, 592.16, 592.2;
383/109, 110, 113; 280/47.17, 47.371; 190/18 A,
190/100, 109, 110–113, 127, 900

See application file for complete search history.

FIG. 1 is a perspective view of the collapsible and foldable rolling cooler of my design, showing in its fully open position;

FIG. 2 is a front elevational view thereof, shown in its collapsed position with the cover flap folded inwardly;

FIG. 3 is a side elevational view thereof, looking from the left side of FIG. 2, the opposite side being a mirror image thereof;

FIG. 4 is a rear elevational view thereof;

FIG. 5 is a top plan view thereof;

FIG. 6 is a bottom plan view thereof;

FIG. 7 is a front elevational view thereof in an alternate configuration, the cover flap is folded outwardly;

FIG. 8 is a side view of FIG. 7;

FIG. 9 is a top plan view of FIG. 7; and,

FIG. 10 is a bottom plan view of FIG. 7.

(56) **References Cited**

U.S. PATENT DOCUMENTS

- 4,724,681 A * 2/1988 Bartholomew et al. 62/239
- D347,971 S * 6/1994 Krugman D7/607
- D354,397 S * 1/1995 Berman D3/276
- D357,354 S * 4/1995 Marchwiak et al. D3/279
- D387,249 S * 12/1997 Mogil D7/607
- D387,625 S * 12/1997 Kai Fai D7/605

1 Claim, 5 Drawing Sheets

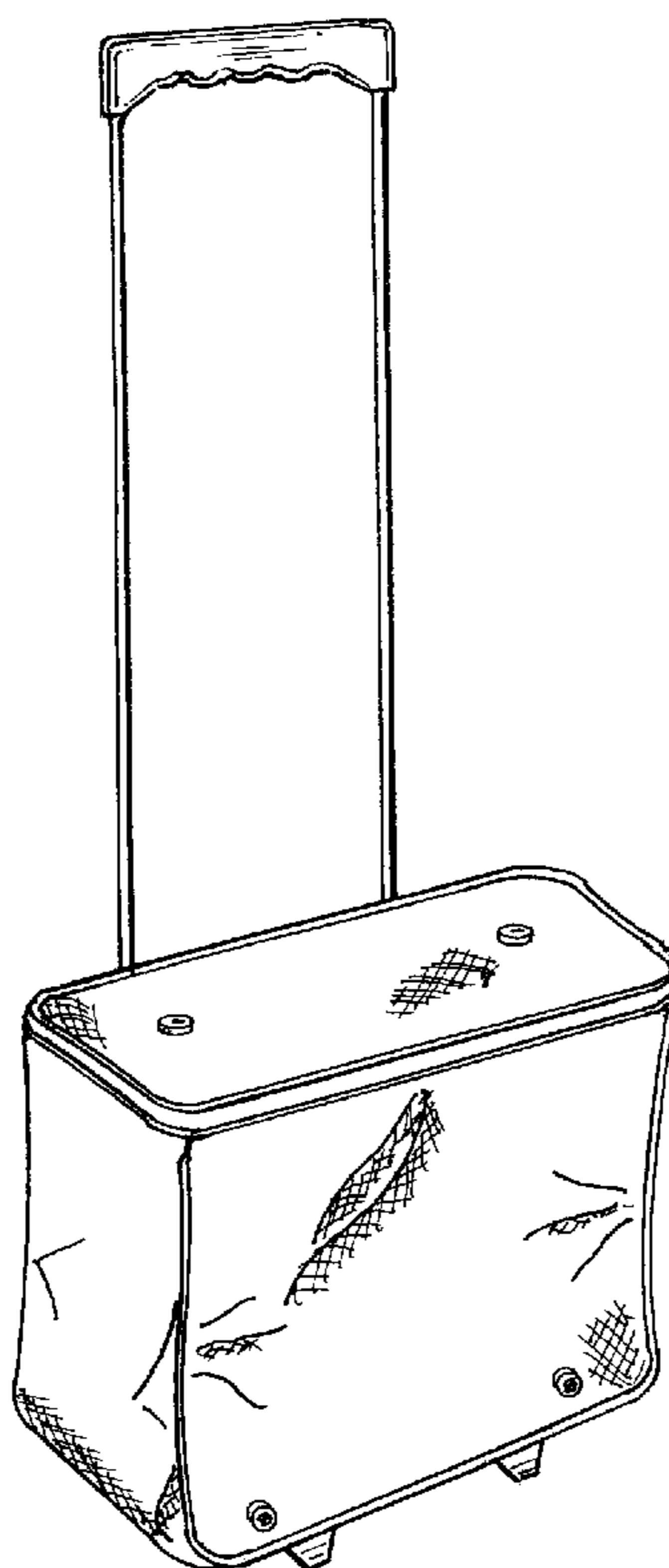

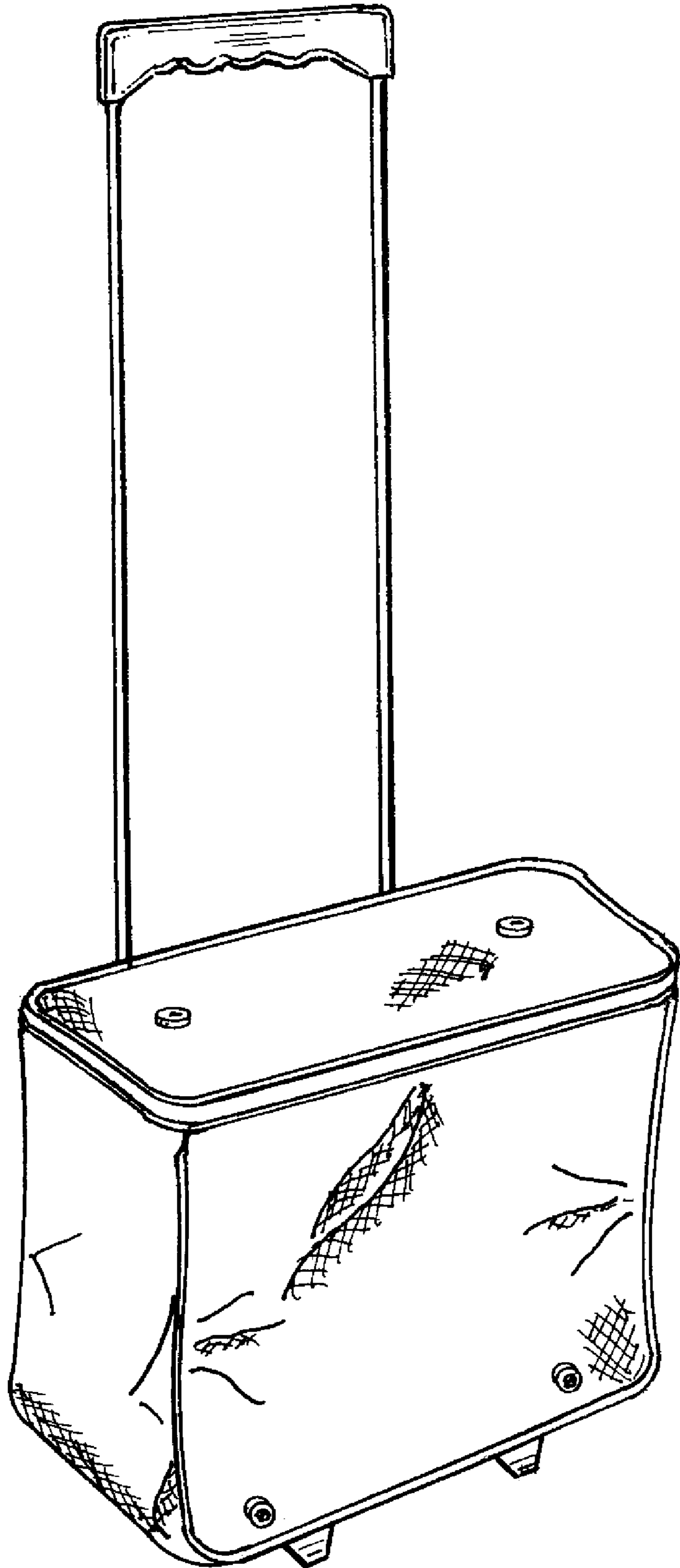

FIG. 1

FIG. 2

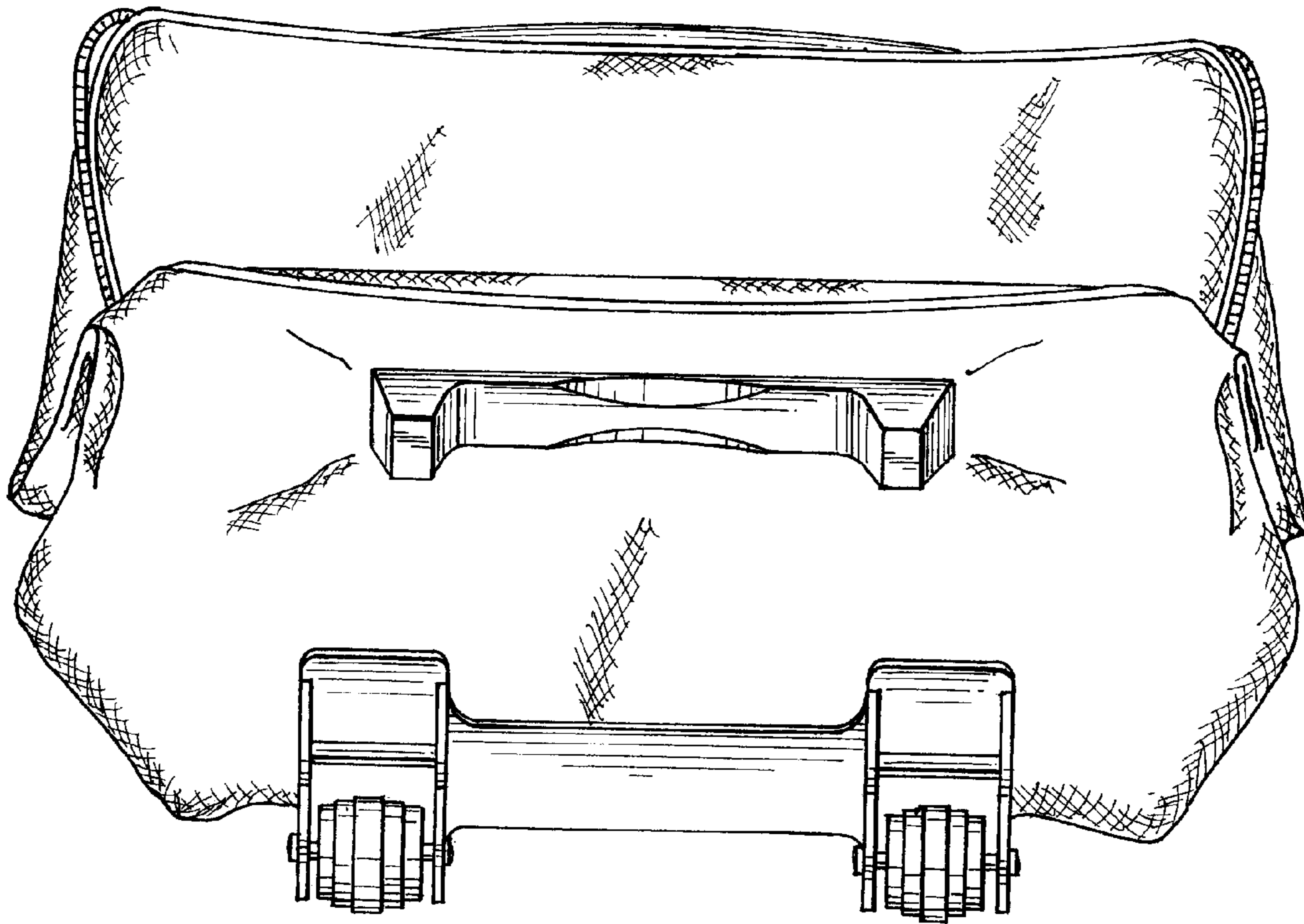

FIG. 6

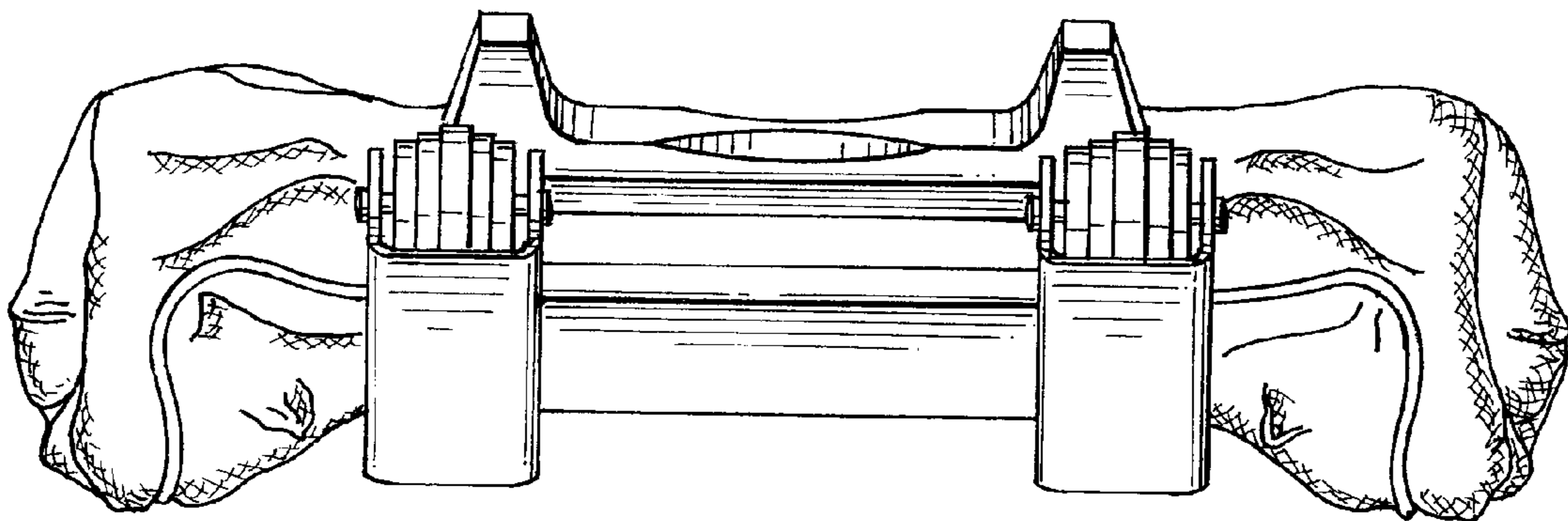

FIG. 3

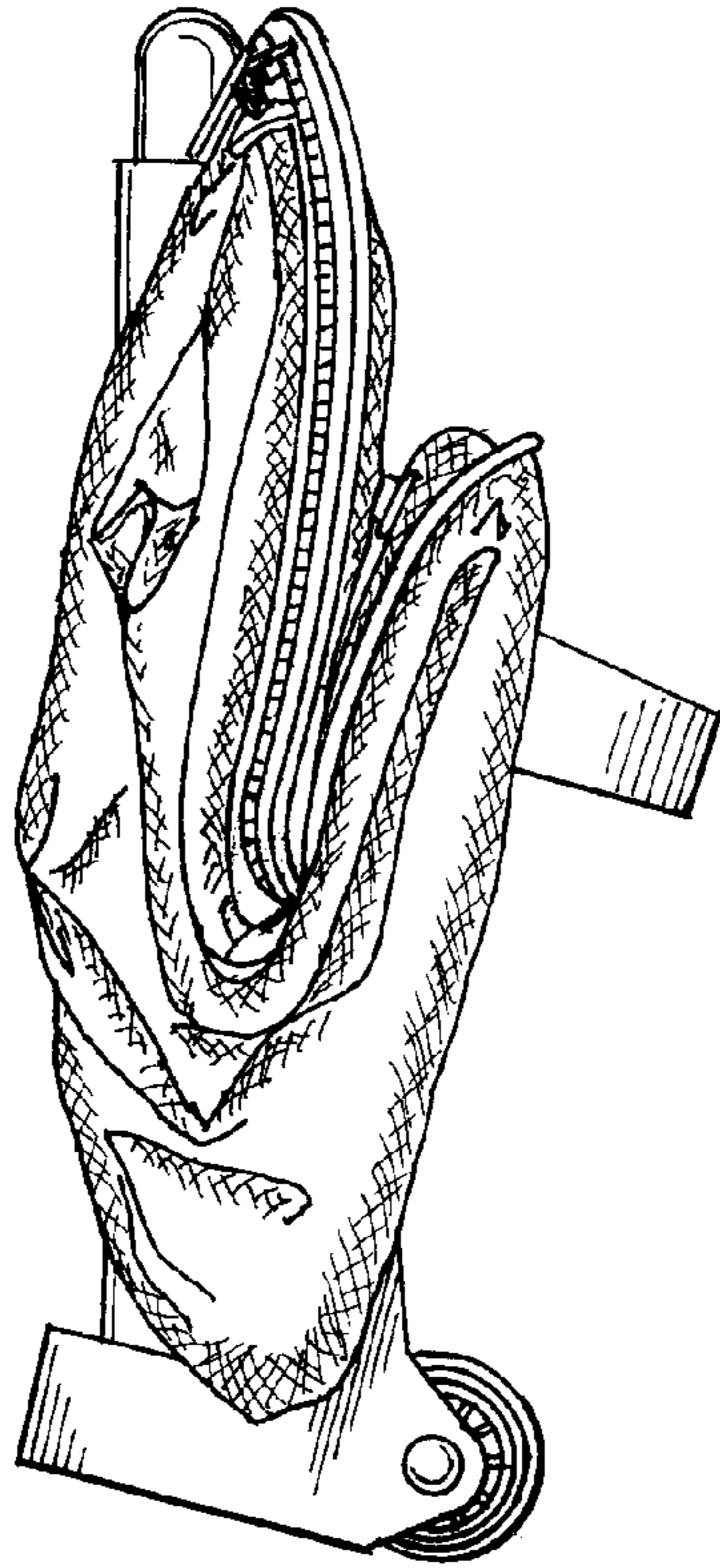

FIG. 8



FIG. 7

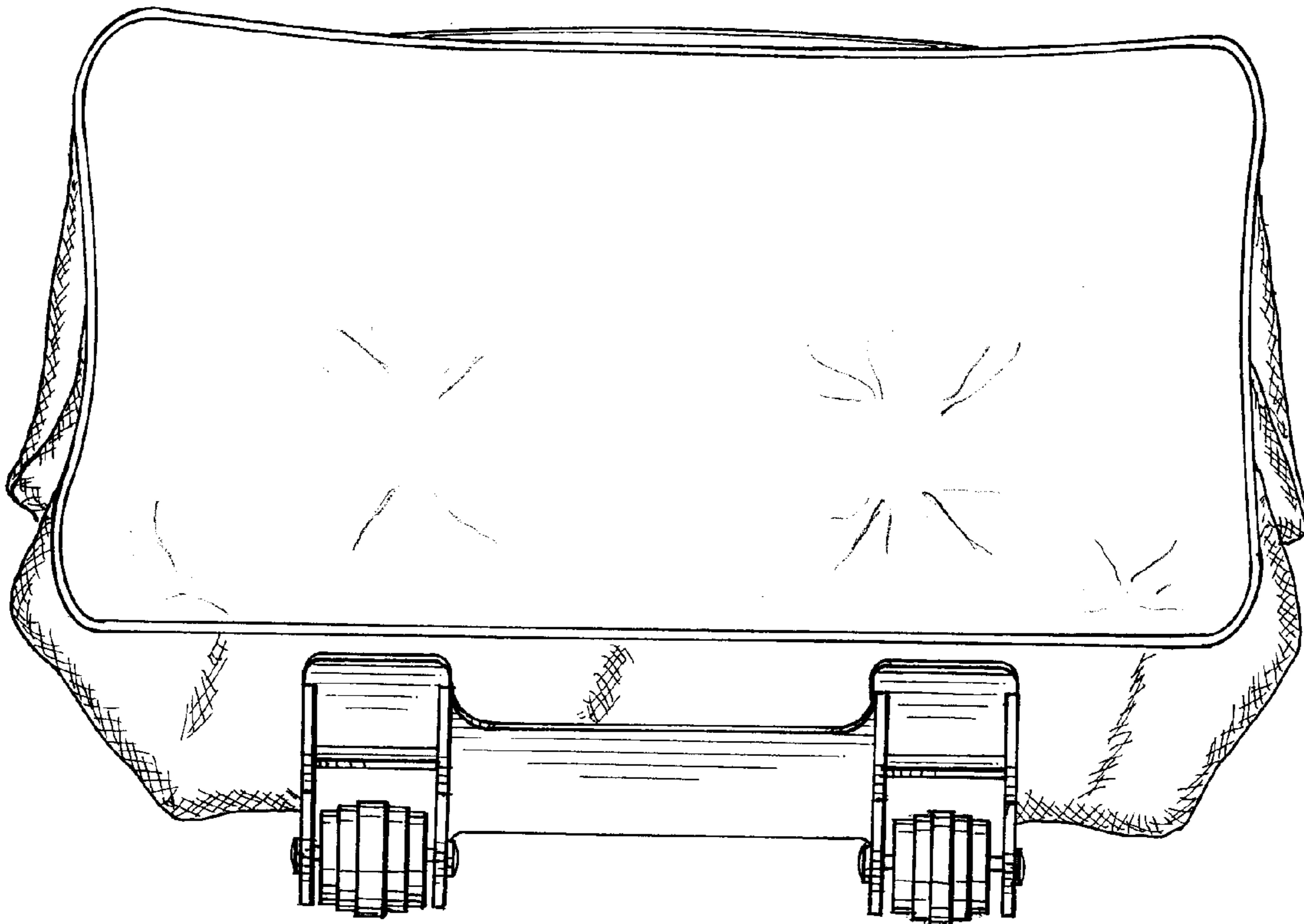

FIG. 4

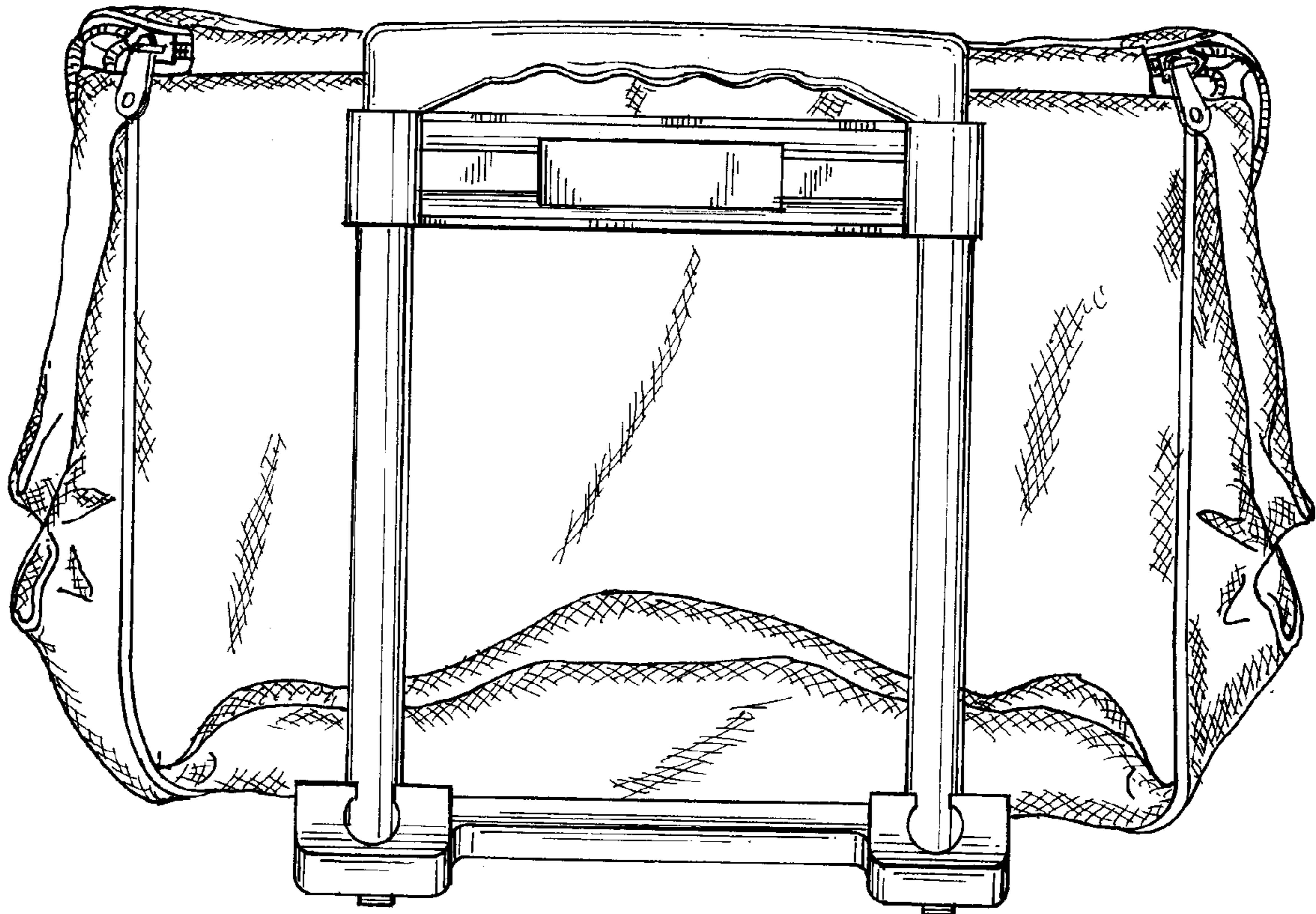

FIG. 5

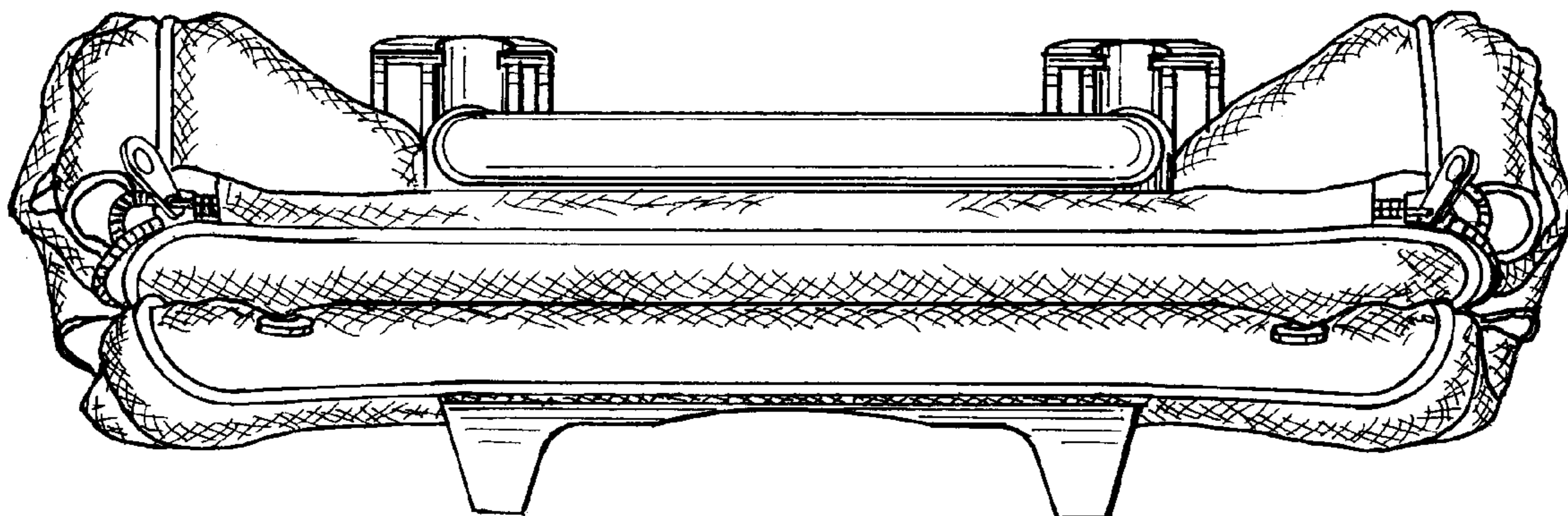

FIG. 9

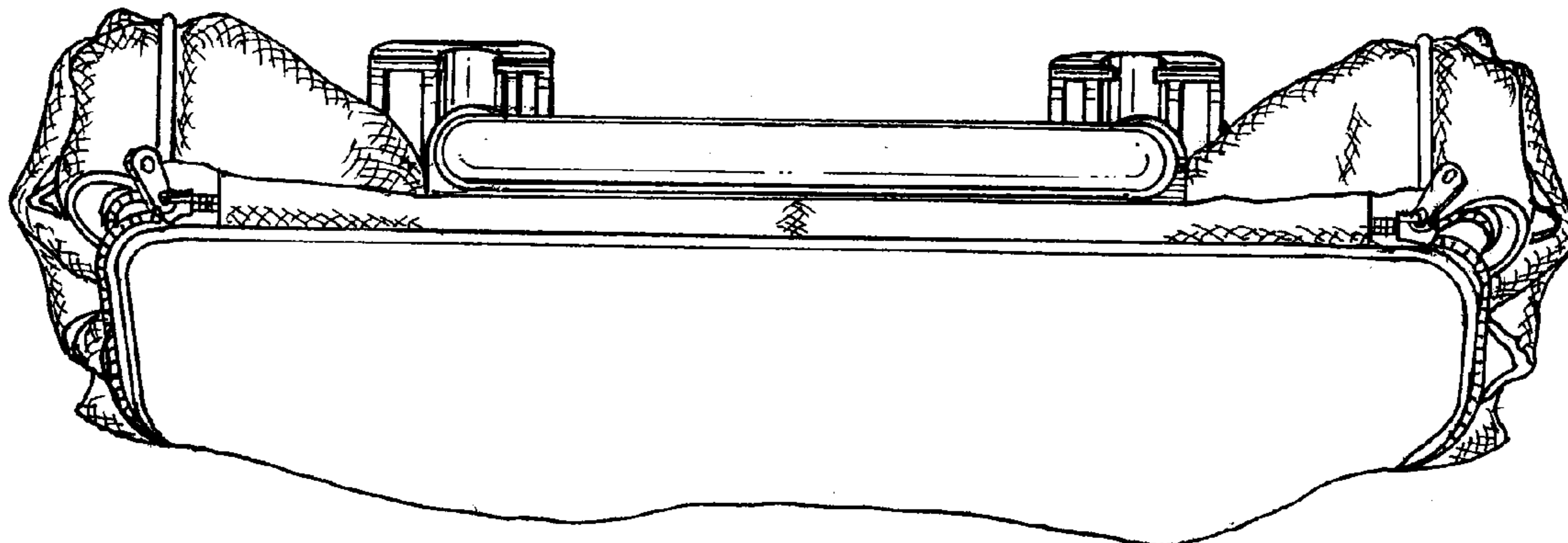

FIG. 10

