

US00D528350S

(12) **United States Design Patent**  
**McHutchison**

(10) **Patent No.:** **US D528,350 S**  
(45) **Date of Patent:** **\*\* Sep. 19, 2006**

(54) **COMPACT TOASTER GRILL**

FOREIGN PATENT DOCUMENTS

(75) Inventor: **Bryan McHutchison**, Sydney (AU)

GB 2002484 \* 4/1990

(73) Assignee: **Breville Pty Limited**, Botany (AU)

GB 2092049 \* 4/2000

(\*\*) Term: **14 Years**

GB 2387531 A \* 10/2003

(21) Appl. No.: **29/196,036**

\* cited by examiner

(22) Filed: **Dec. 22, 2003**

*Primary Examiner*—Caron D. Veynar

*Assistant Examiner*—Ricky Pham

(30) **Foreign Application Priority Data**

(74) *Attorney, Agent, or Firm*—Moils & Co.

Jul. 2, 2003 (AU) ..... 2281/03

(57) **CLAIM**

The ornamental design for a compact toaster grill, as shown and described.

(51) **LOC (8) Cl.** ..... **07-02**

**DESCRIPTION**

(52) **U.S. Cl.** ..... **D7/352**

(58) **Field of Classification Search** ..... D7/323,  
D7/328-332, 334-339, 352-363; 99/425,  
99/444, 466, 219, 618, 620, 601, 386, 385,  
99/369, 331, 339, 349, 372, 389, 446; 219/620-622;  
222/33

See application file for complete search history.

FIG. 1 is a front perspective view of a compact toaster grill showing my new design.

FIG. 2 is a rear perspective view thereof;

FIG. 3 is a front elevation view thereof;

FIG. 4 is a rear elevation view thereof;

FIG. 5 is a left side elevation view thereof;

FIG. 6 is a right side elevation view thereof;

FIG. 7 is a top plan view thereof; and,

FIG. 8 is a bottom plan view thereof.

The article is depicted with a front located and separate drip tray, which does not form part of the design.

The broken lines showing a drip tray in FIGS. 1-3 and FIGS. 5-8 is for illustrative purposes only and form no part of the claimed design.

(56) **References Cited**

U.S. PATENT DOCUMENTS

D213,931 S \* 4/1969 Bardeau ..... D7/352

D232,012 S \* 7/1974 Bardeau ..... D7/352

D436,794 S \* 1/2001 McClean ..... D7/352

D452,109 S \* 12/2001 Hensel ..... D7/352

6,363,835 B1 \* 4/2002 Wu ..... 99/331

6,439,108 B1 \* 8/2002 Wu ..... 99/349

D479,665 S \* 9/2003 Barker ..... D7/352

D509,703 S \* 9/2005 Barker ..... D7/352

**1 Claim, 6 Drawing Sheets**

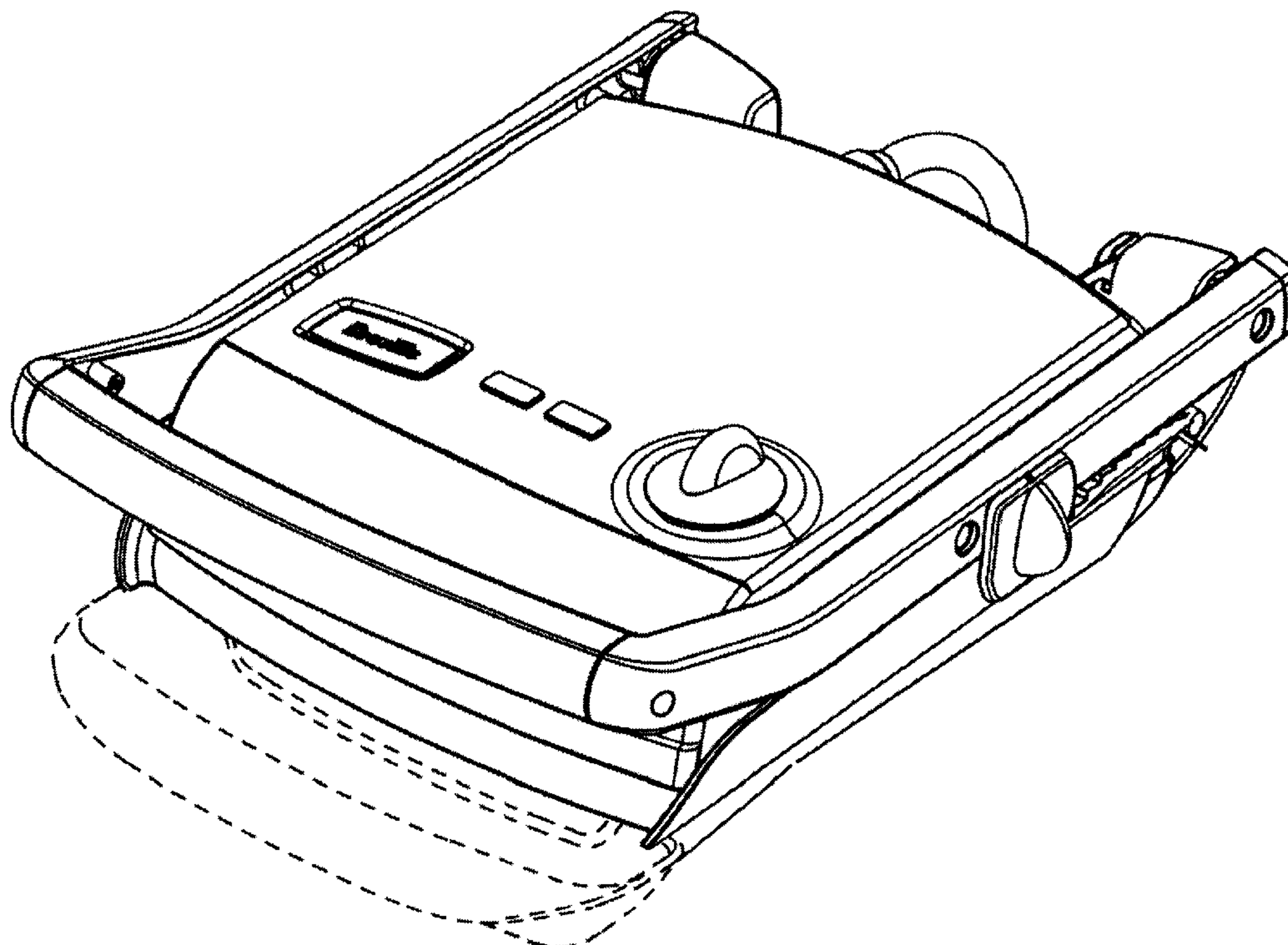

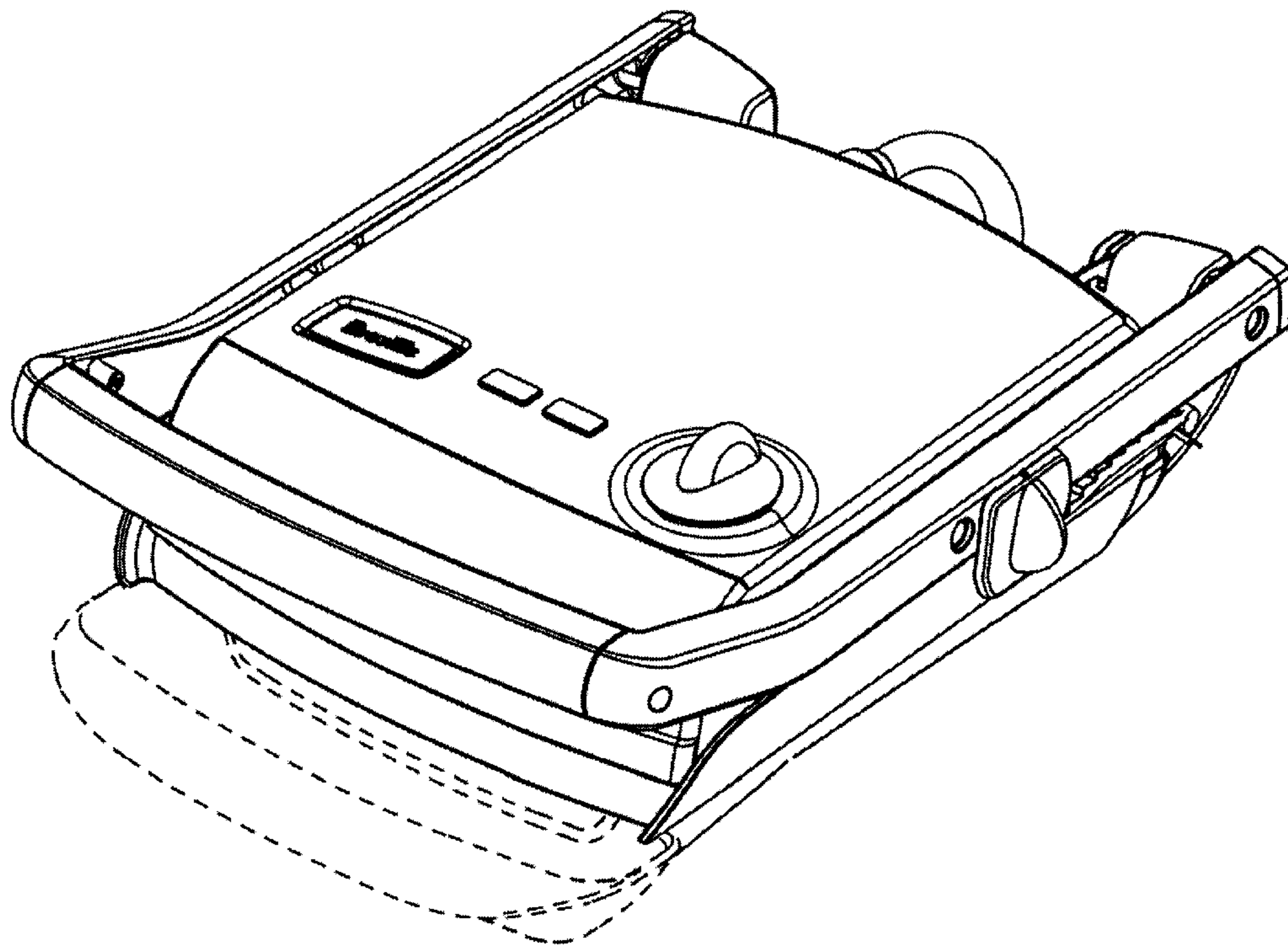

FIG. 1

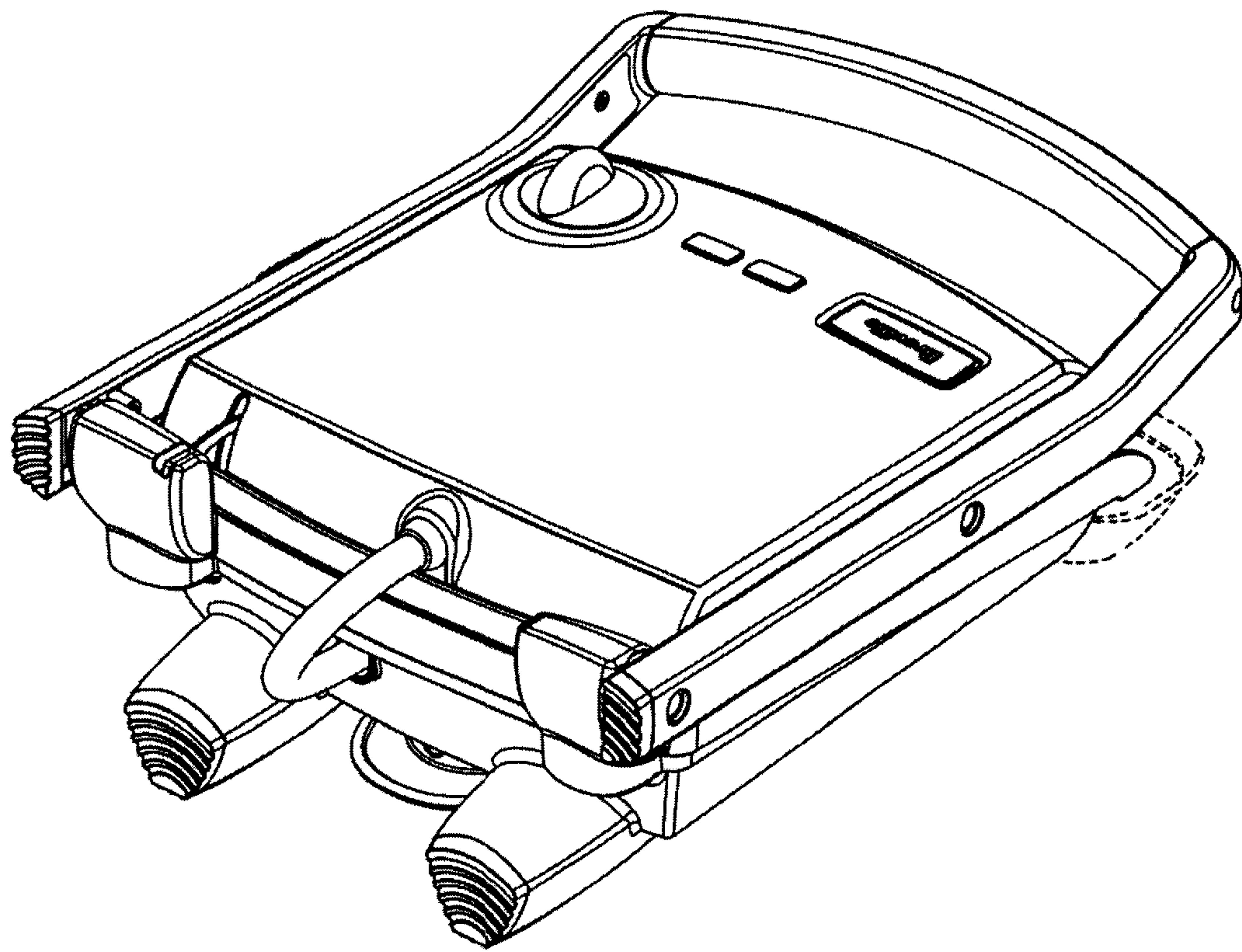

FIG. 2



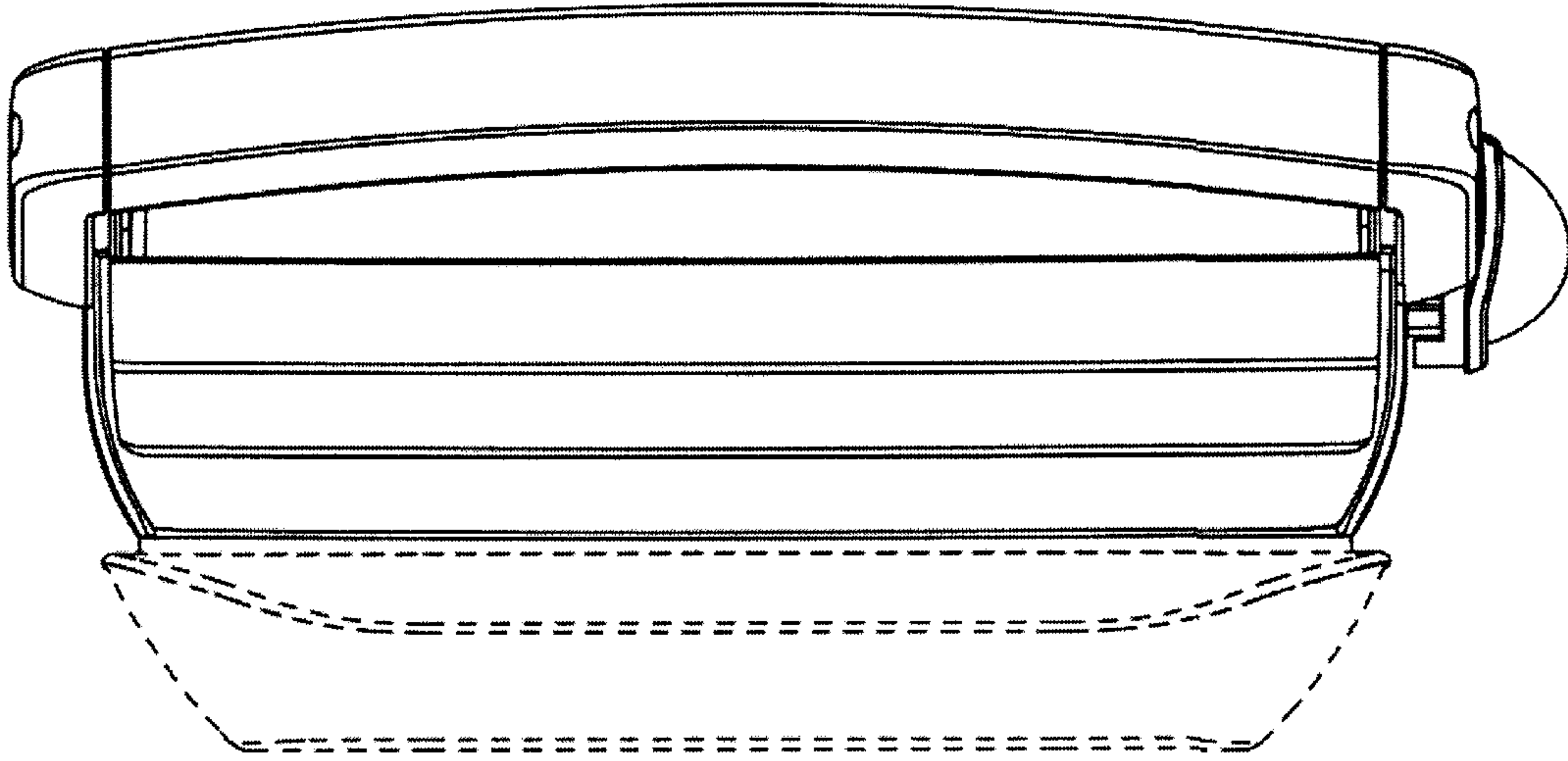

FIG. 3

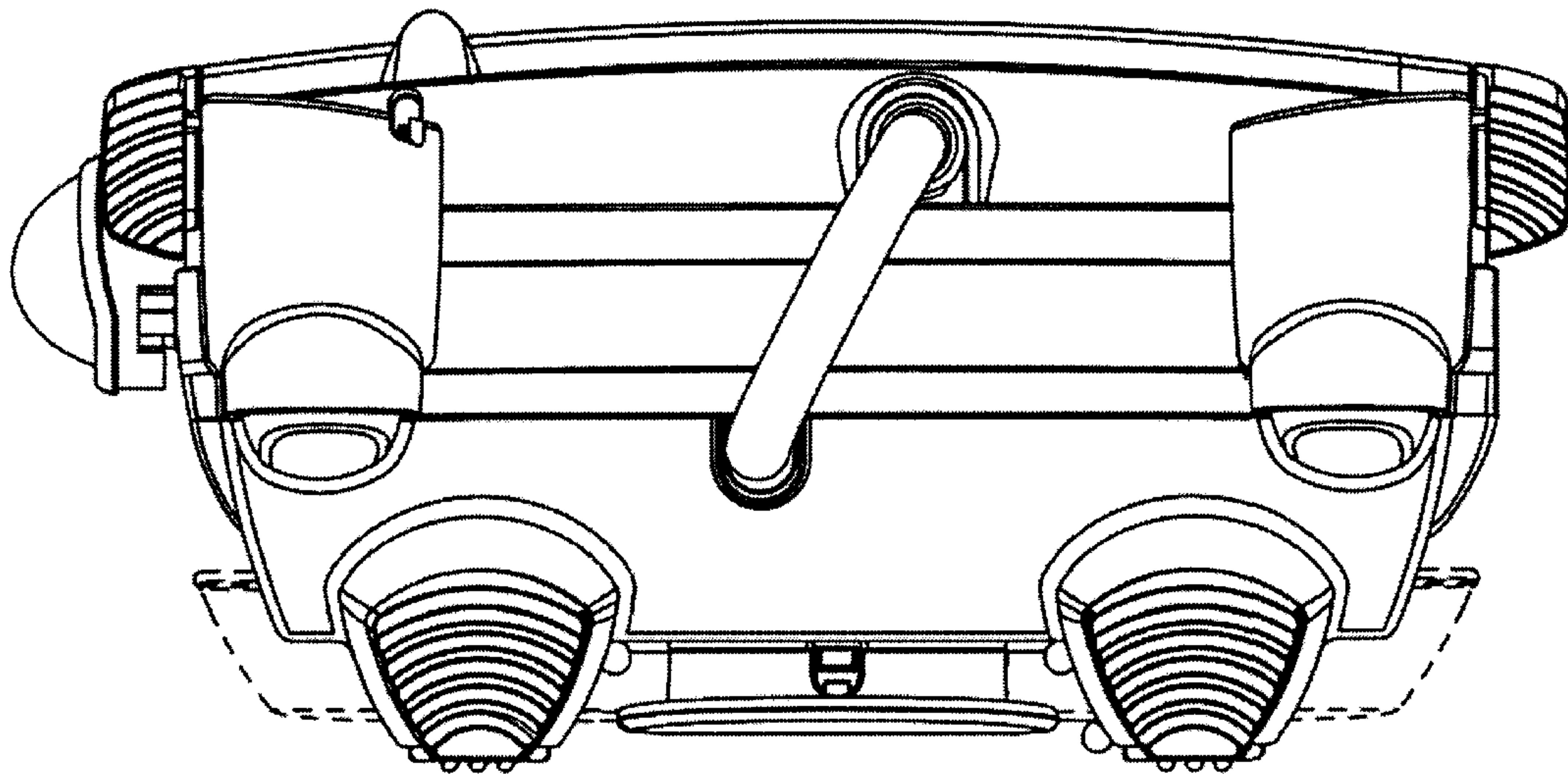

FIG. 4

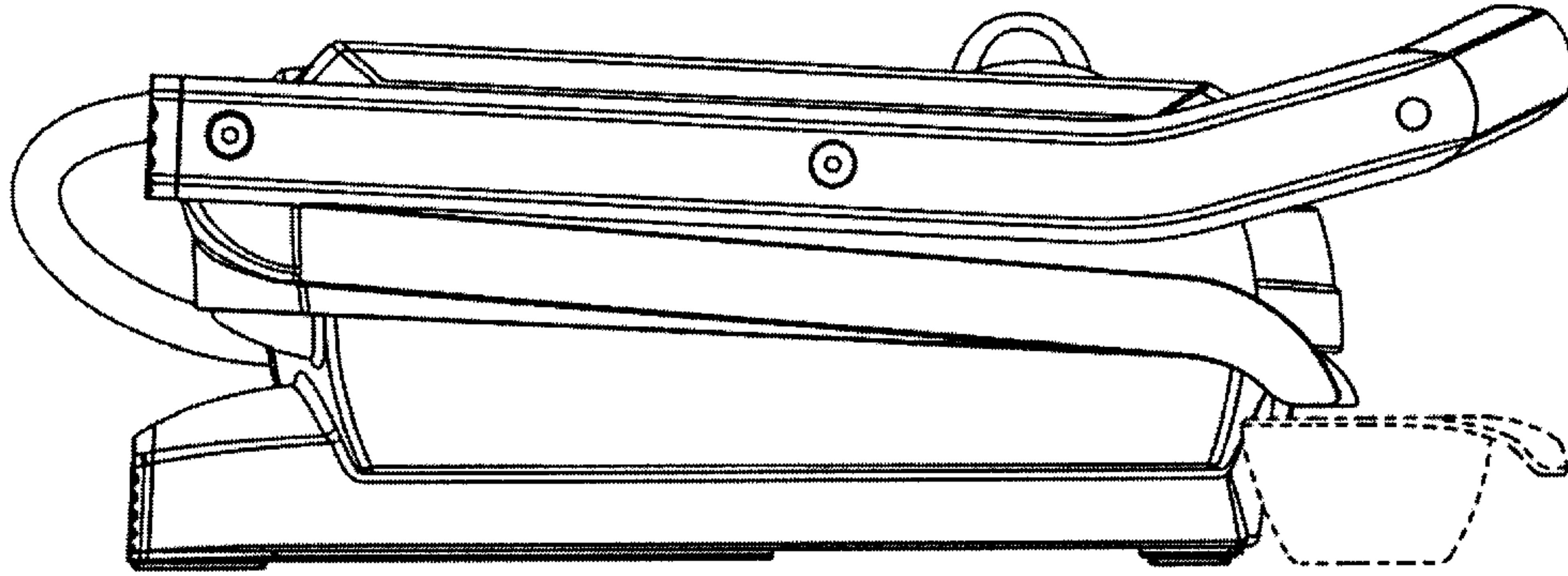

FIG. 5

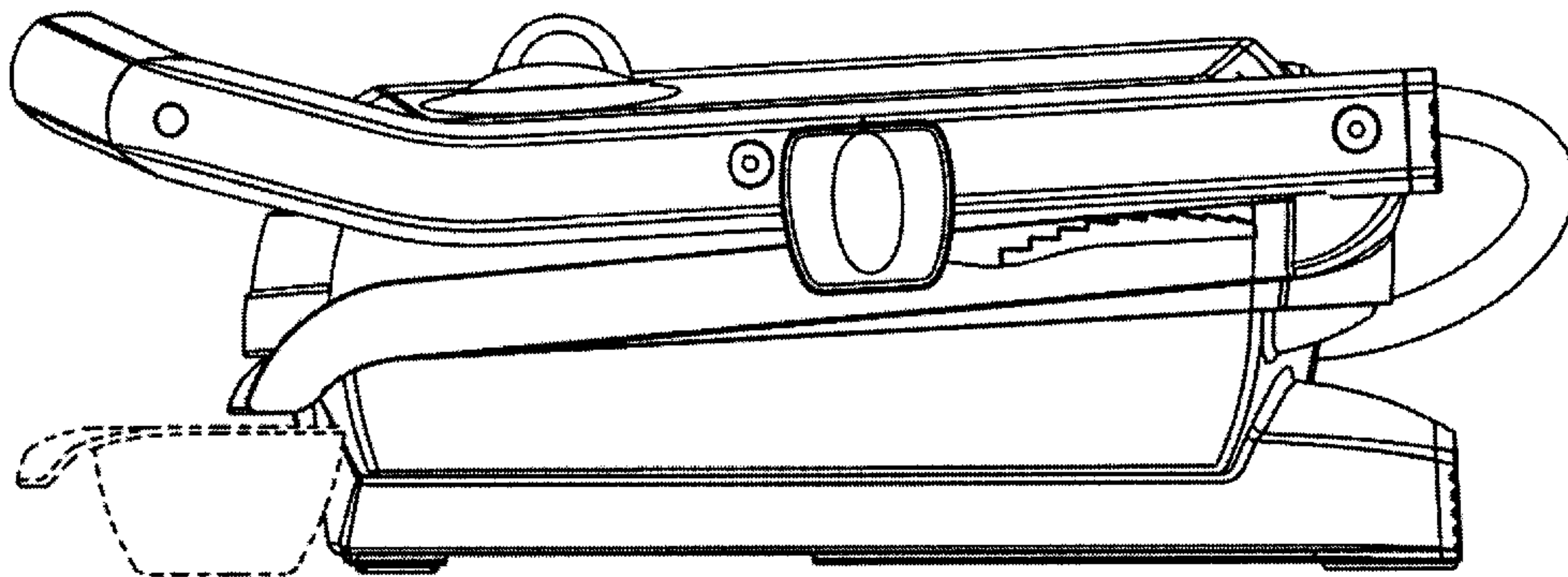

FIG. 6

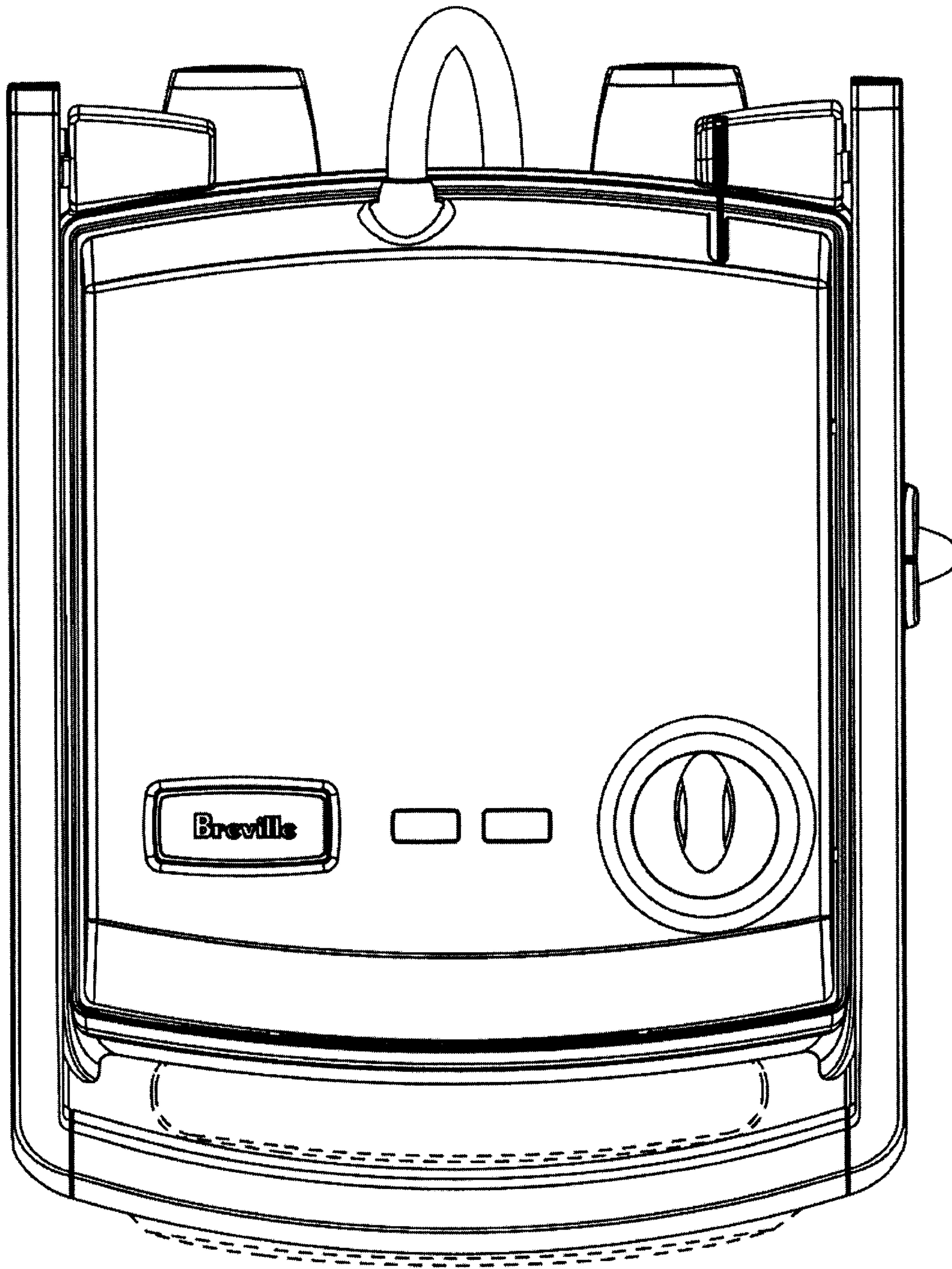

FIG. 7



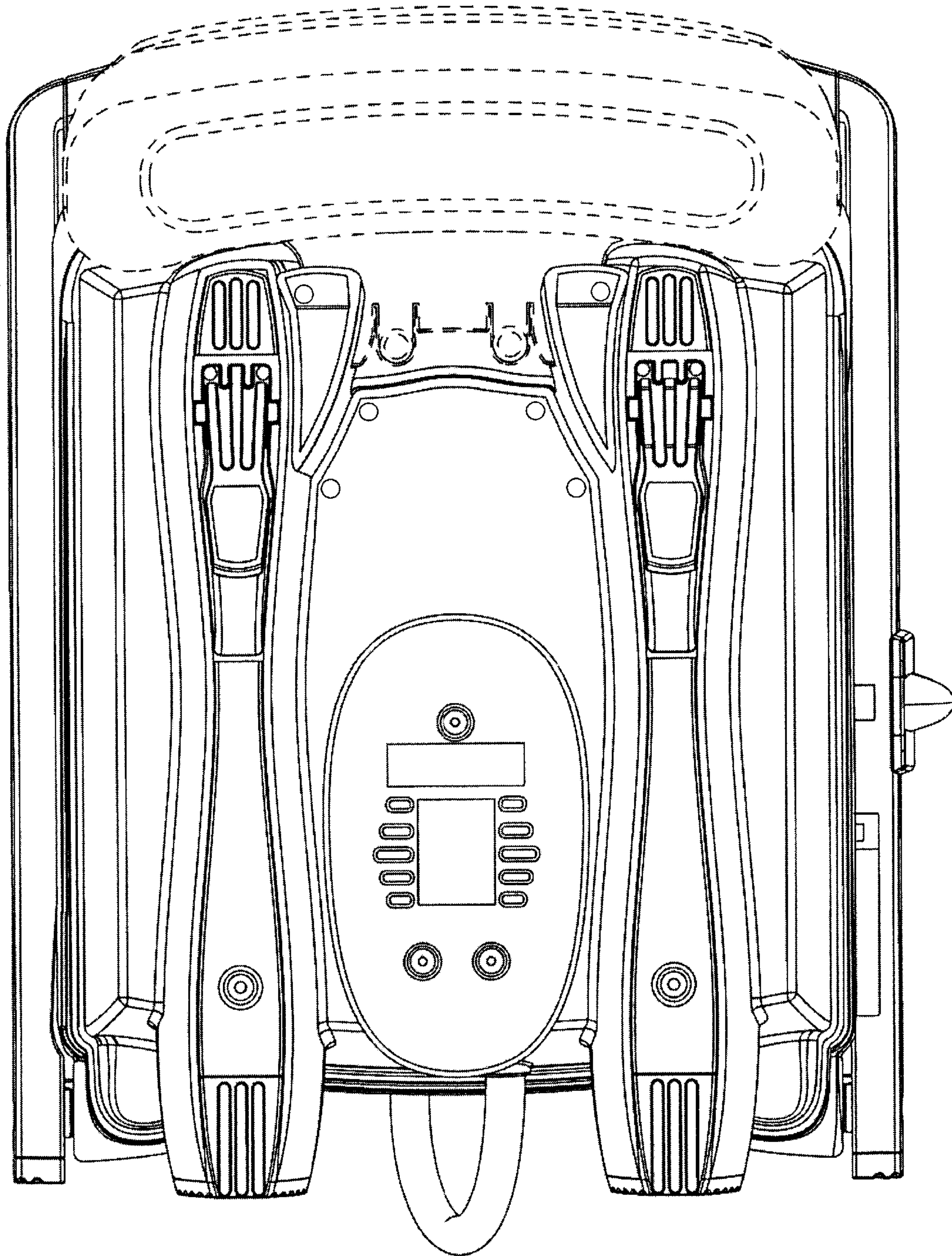

FIG. 8