

US00D528202S

(12) **United States Design Patent**  
**Shapiro**

(10) **Patent No.:** **US D528,202 S**

(45) **Date of Patent:** **\*\* Sep. 12, 2006**

(54) **BODY FOR A VERTICAL FAN**

D483,851 S \* 12/2003 Fok ..... D23/378

(75) Inventor: **Barry Shapiro**, Doylestown, PA (US)

\* cited by examiner

(73) Assignee: **Lasko Holdings, Inc.**, Wilmington, DE (US)

*Primary Examiner*—Lisa Lichtenstein

(74) *Attorney, Agent, or Firm*—RatnerPrestia

(\*\*) Term: **14 Years**

(57) **CLAIM**

The ornamental design for a body for a vertical fan, as shown and described.

(21) Appl. No.: **29/233,785**

(22) Filed: **Jul. 8, 2005**

**DESCRIPTION**

(51) **LOC (8) Cl.** ..... **23-04**

(52) **U.S. Cl.** ..... **D23/411**

(58) **Field of Classification Search** ..... D23/378,  
D23/370, 411, 381; 416/244 R, 247 R; 415/53.1–53.3;  
392/365, 367

See application file for complete search history.

FIG. 1 is a right side front perspective view of a body for a vertical fan showing my new design;

FIG. 2 is a rear perspective view thereof;

FIG. 3 is a front elevation view thereof;

FIG. 4 is a side elevation view thereof, the opposite side being a mirror image of that shown;

FIG. 5 is a rear elevation view thereof; and,

FIG. 6 is an enlarged top plan view thereof.

The broken line showing of environmental structure in FIGS. 1–6 is for illustrative purposes only and forms no part of the claimed design.

(56) **References Cited**

U.S. PATENT DOCUMENTS

D271,132 S \* 10/1983 Boldt et al. .... D23/336

D468,414 S \* 1/2003 Fok ..... D23/328

**1 Claim, 6 Drawing Sheets**

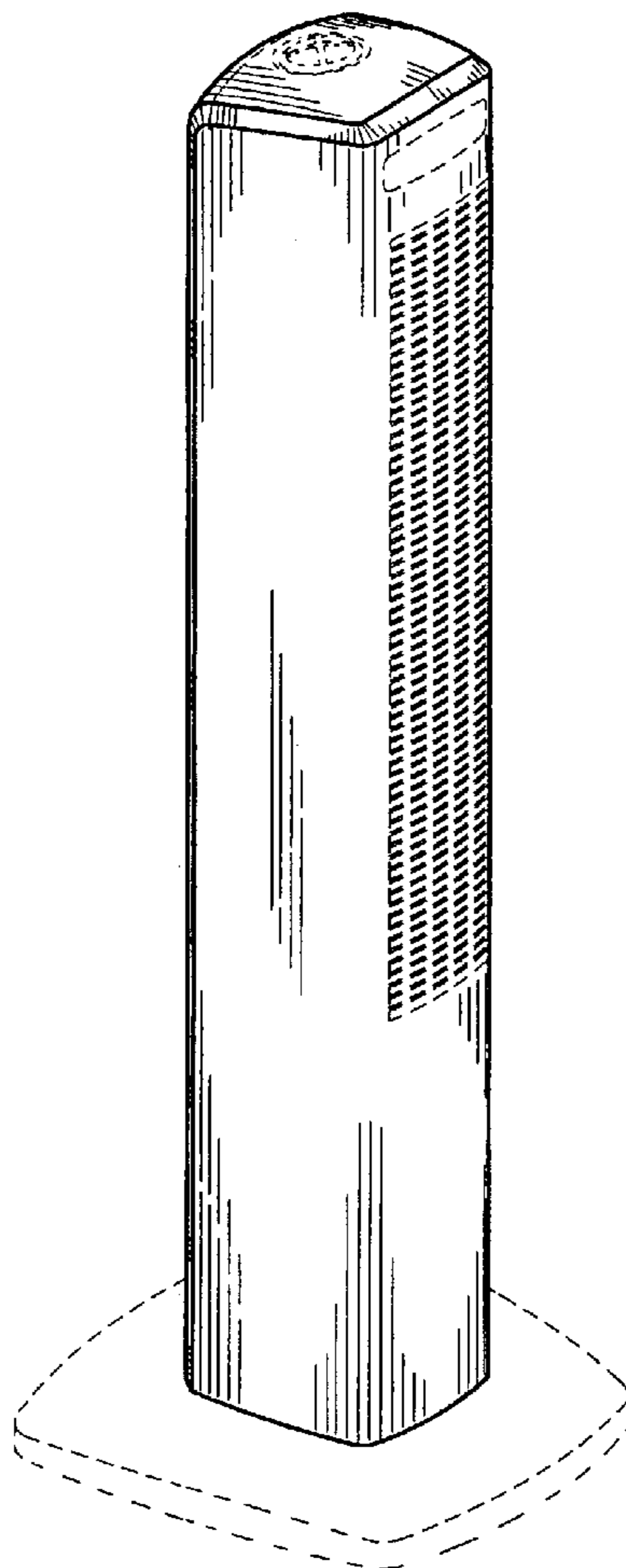

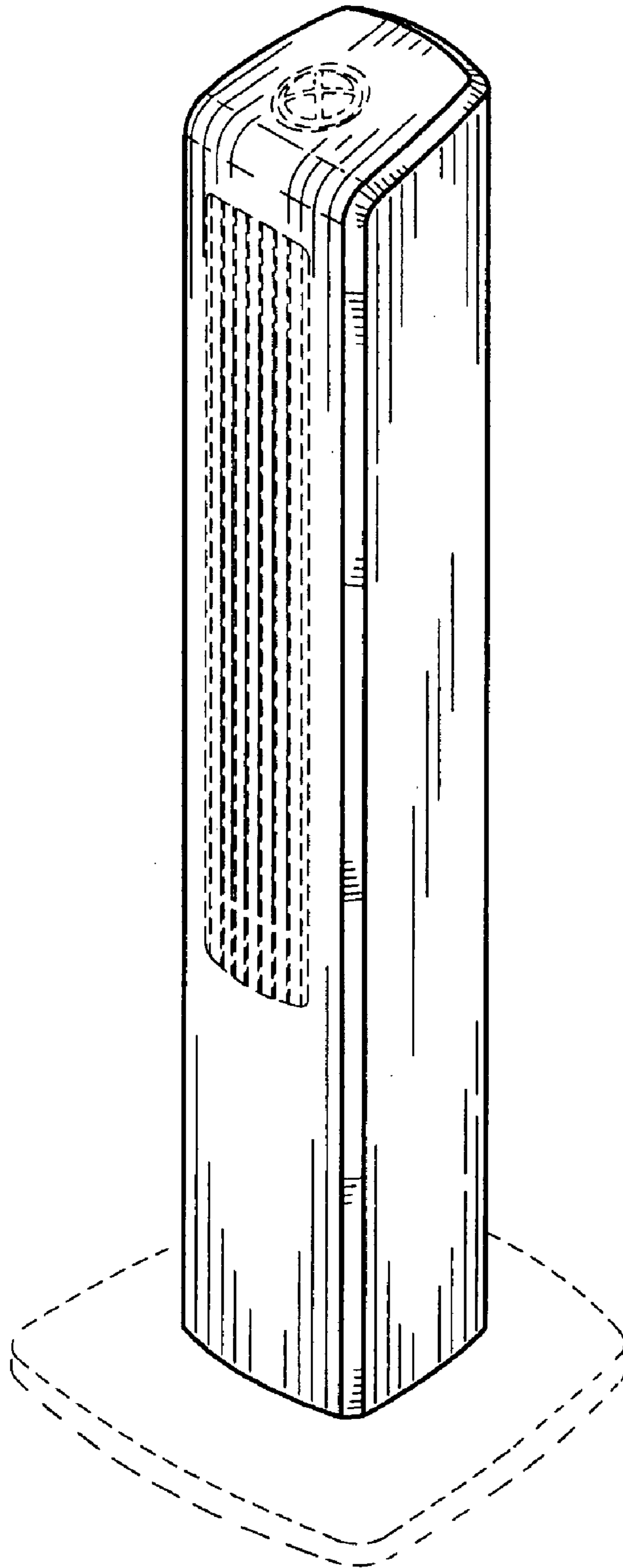

FIG. 1

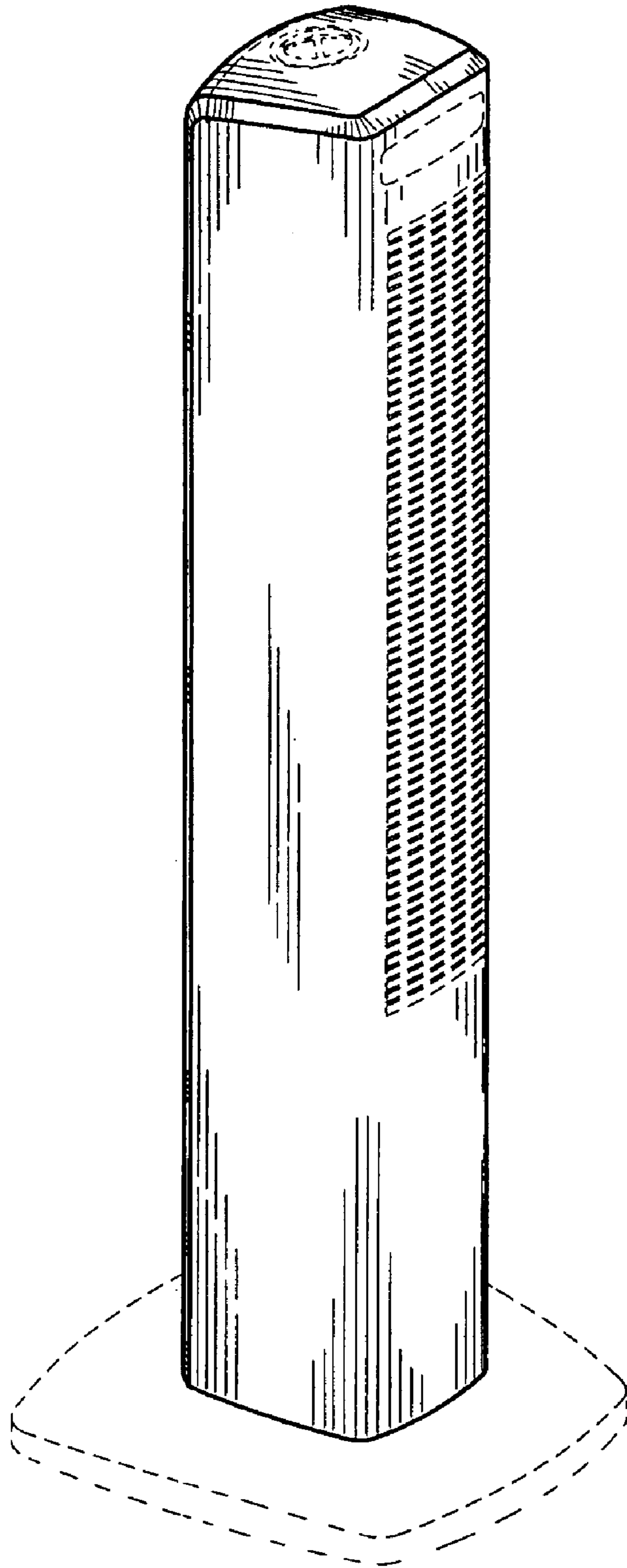

FIG. 2

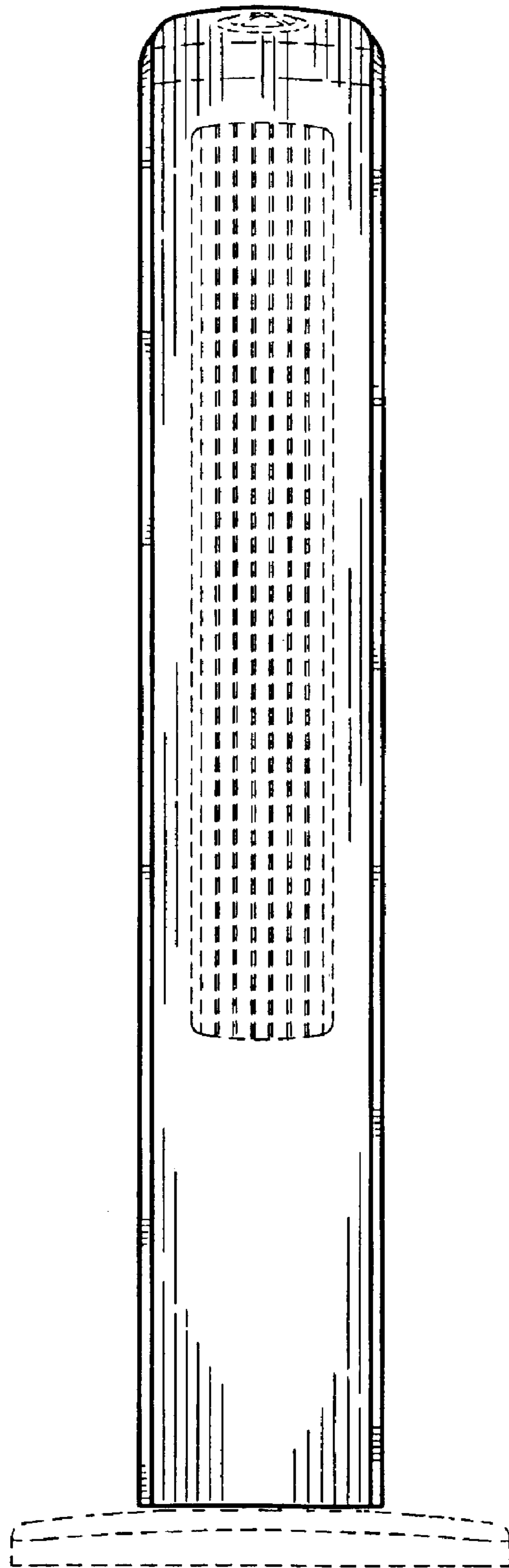

FIG. 3

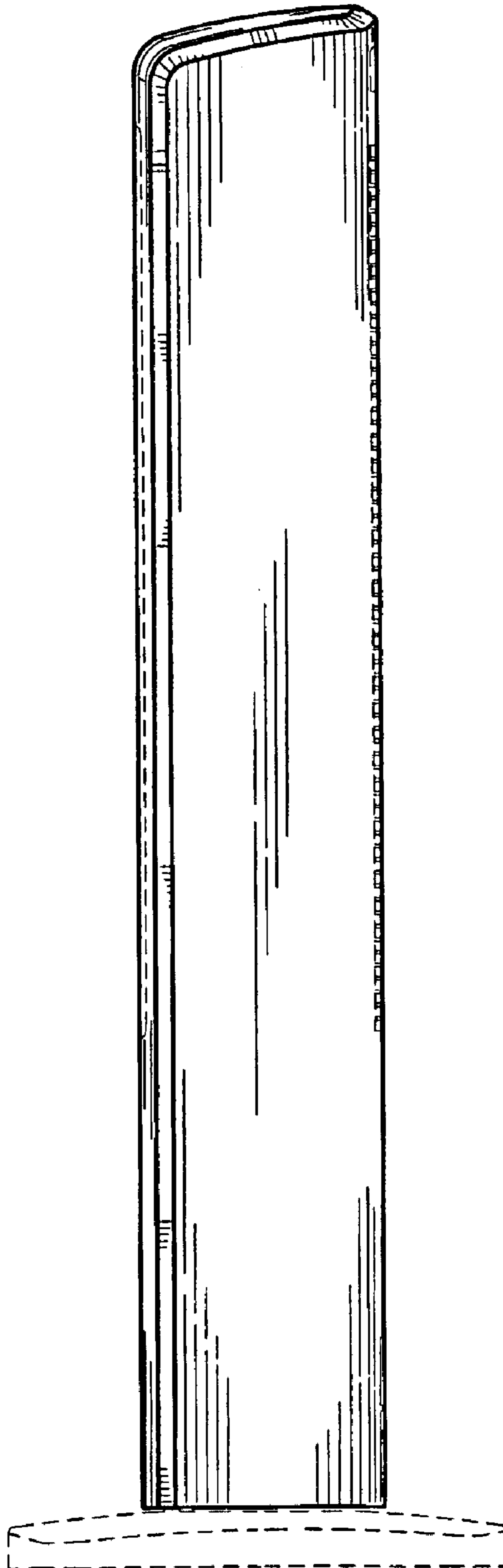

FIG. 4

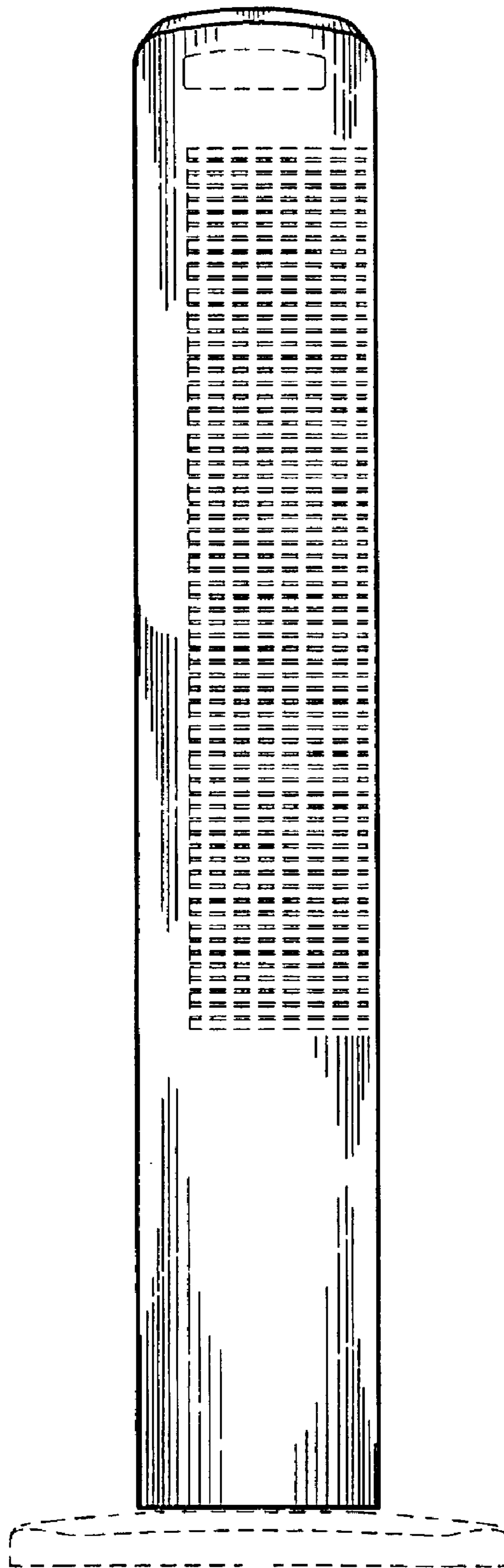

FIG. 5

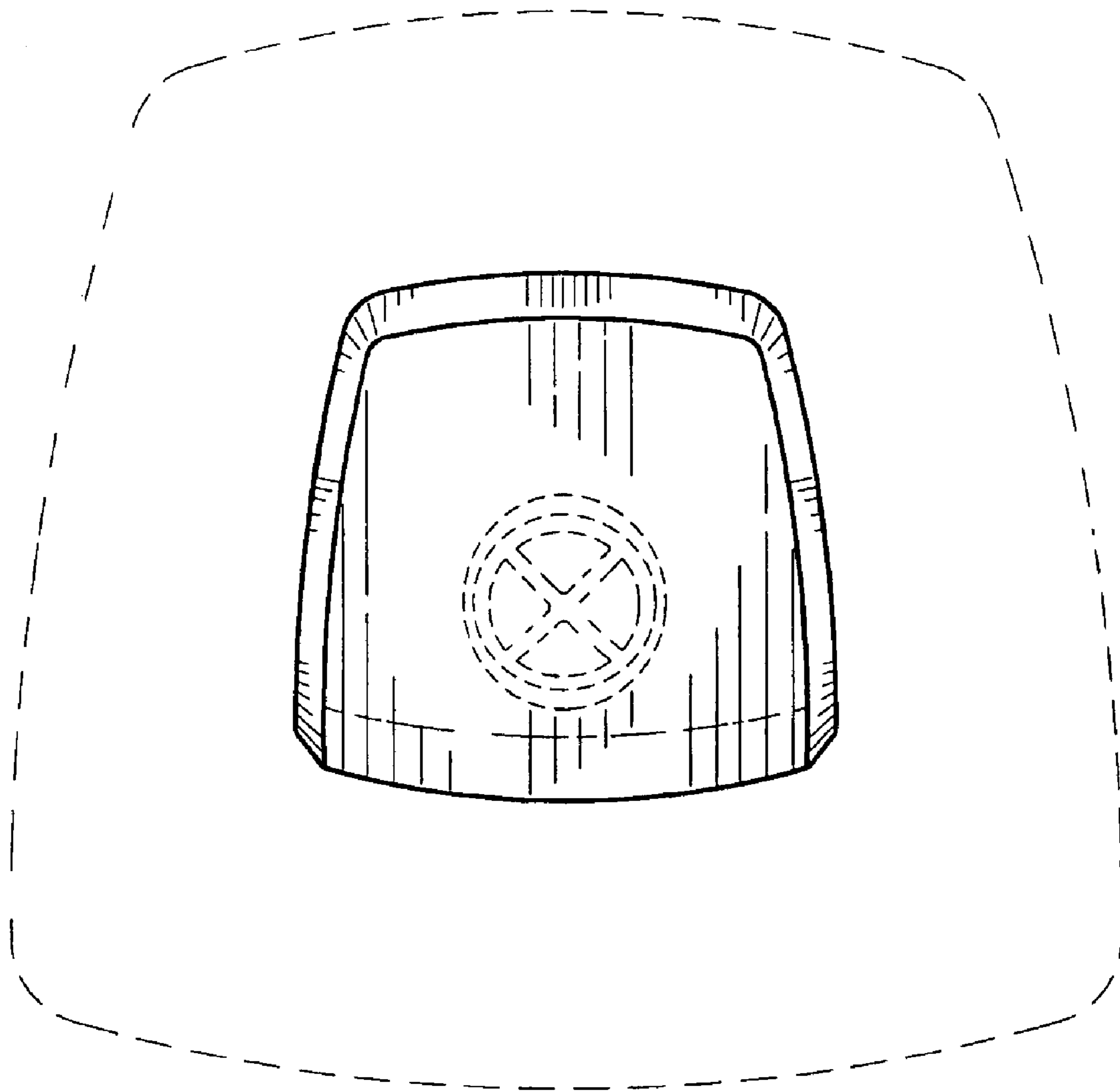

FIG. 6