



US00D528180S

(12) **United States Design Patent**
Rathbun

(10) **Patent No.:** **US D528,180 S**

(45) **Date of Patent:** **** Sep. 12, 2006**

(54) **HOME PLATE**

(76) Inventor: **William J. Rathbun**, 5433 Willow
Bridge La., Fuquay-Varina, NC (US)
27526

(**) Term: **14 Years**

(21) Appl. No.: **29/230,096**

(22) Filed: **May 17, 2005**

Related U.S. Application Data

(63) Continuation-in-part of application No. 10/216,690, filed on
Aug. 12, 2002, now Pat. No. 6,893,365.

(51) **LOC (8) Cl.** **21-02**

(52) **U.S. Cl.** **D21/780**

(58) **Field of Classification Search** D21/698,
D21/699, 706, 715, 717, 719, 780, 686, 687,
D21/694, 695, 797, 798, 803, 804, 809; D10/46.1,
D10/71, 72; D6/502, 585, 595, 596, 601,
D6/610, 611; 473/415-417, 451-456, 468,
473/476, 490, 499, 500, 501
See application file for complete search history.

(56) **References Cited**

U.S. PATENT DOCUMENTS

3,668,781	A	6/1972	Teter	33/1
3,971,558	A	7/1976	Gardetto	273/25
4,160,324	A	7/1979	Dunn	33/137 R
4,227,691	A	* 10/1980	Lefebvre et al.	473/417
4,267,637	A	5/1981	Paull	33/1 G
4,381,607	A	5/1983	Place	33/1 G
4,830,371	A	* 5/1989	Lay	473/423
4,880,232	A	11/1989	Lang	273/32 B
4,978,121	A	12/1990	Larkey	273/26 A
5,371,949	A	12/1994	Delaurier	33/1 G
5,401,016	A	* 3/1995	Heglund et al.	473/476
5,556,090	A	9/1996	Coleman	273/25
5,613,678	A	* 3/1997	McKee et al.	473/397
5,642,880	A	7/1997	Wiseman et al.	473/417
5,657,984	A	8/1997	Leo	124/20.1
5,772,536	A	* 6/1998	Wang	473/417
5,803,841	A	9/1998	Daskoski	473/454
6,026,585	A	2/2000	Li	33/767
D451,159	S	* 11/2001	Rojas et al.	D21/680

6,413,175	B1	* 7/2002	Mooney, Jr.	473/417
6,430,819	B1	8/2002	Aldstadt et al.	33/1 G
6,440,004	B1	8/2002	Rodriguez	473/218
D479,290	S	* 9/2003	DeChenne	D21/717
2003/0032506	A1	* 2/2003	Chi	473/417

OTHER PUBLICATIONS

SPORTIME(R) Fall 2002 Catalog, scooters shown on p.
86.*

* cited by examiner

Primary Examiner—Catherine Tuttle

(74) *Attorney, Agent, or Firm*—Withrow & Terranova,
PLLC

(57) **CLAIM**

The ornamental design for a home plate, as shown and
described.

DESCRIPTION

FIG. 1 is a back top perspective view of a first embodiment
of the home plate showing my new design.

FIG. 2 is a bottom front perspective view of the home plate
of FIG. 1.

FIG. 3 is a top plan view of the home plate of FIG. 1.

FIG. 4 is a bottom plan view of the home plate of FIG. 1.

FIG. 5 is a front elevational view of the home plate of FIG.
1.

FIG. 6 is a back elevational view of the home plate of FIG.
1.

FIG. 7 is a right side elevational view of the home plate of
FIG. 1.

FIG. 8 is a left side elevational view of the home plate of
FIG. 1.

FIG. 9 is a back top perspective view of a second embodi-
ment of the home plate design.

FIG. 10 is a front bottom perspective view of the home plate
of FIG. 9.

FIG. 11 is a top plan view of the home plate FIG. 9; and,
FIG. 12 is a bottom plan view of the home plate of FIG. 9;
the side elevational views of the second embodiment being
identical to FIGS. 5-8.

The broken lines in the drawings are for illustrative purposes
only, and do not form part of the claimed design.

1 Claim, 7 Drawing Sheets

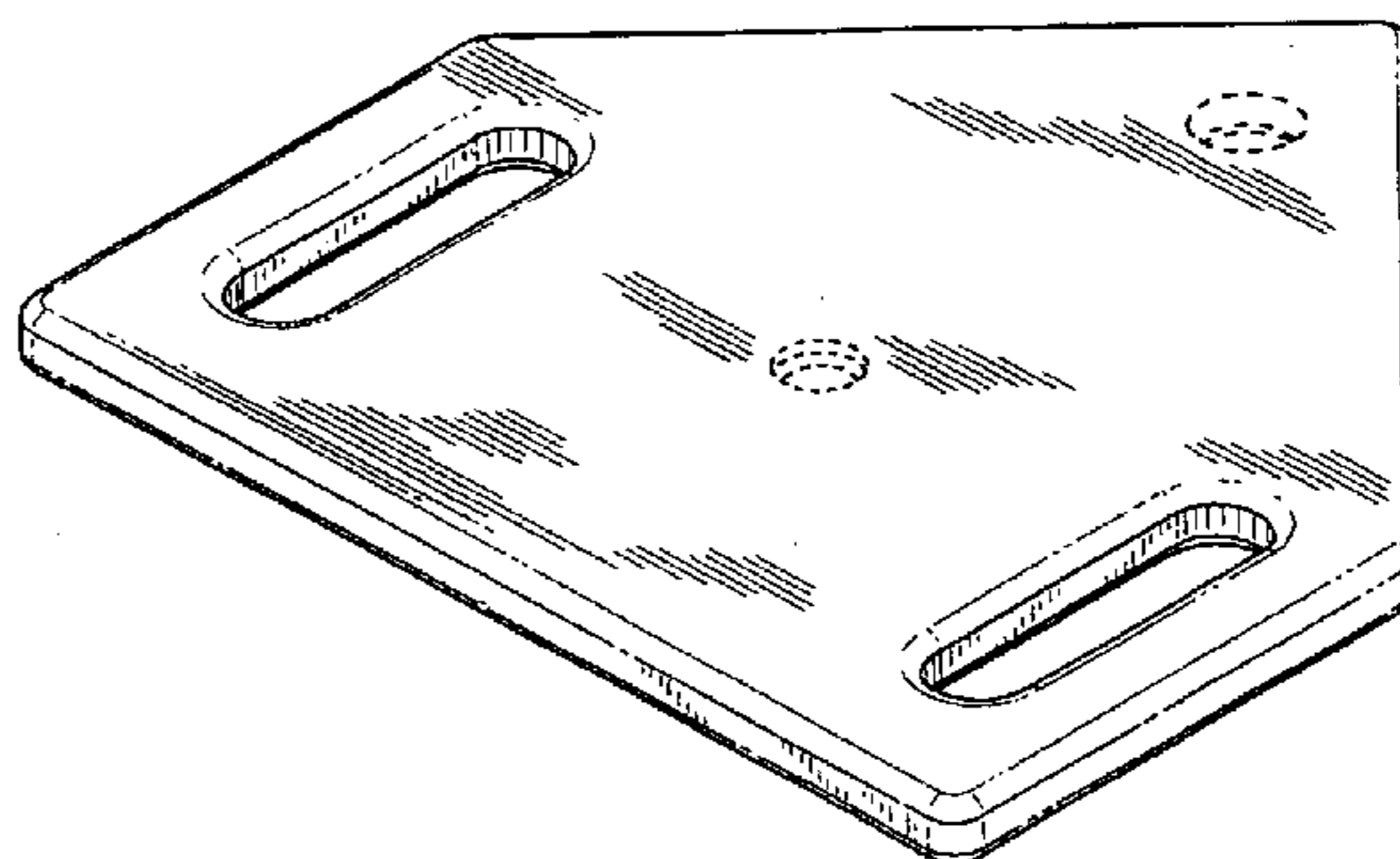
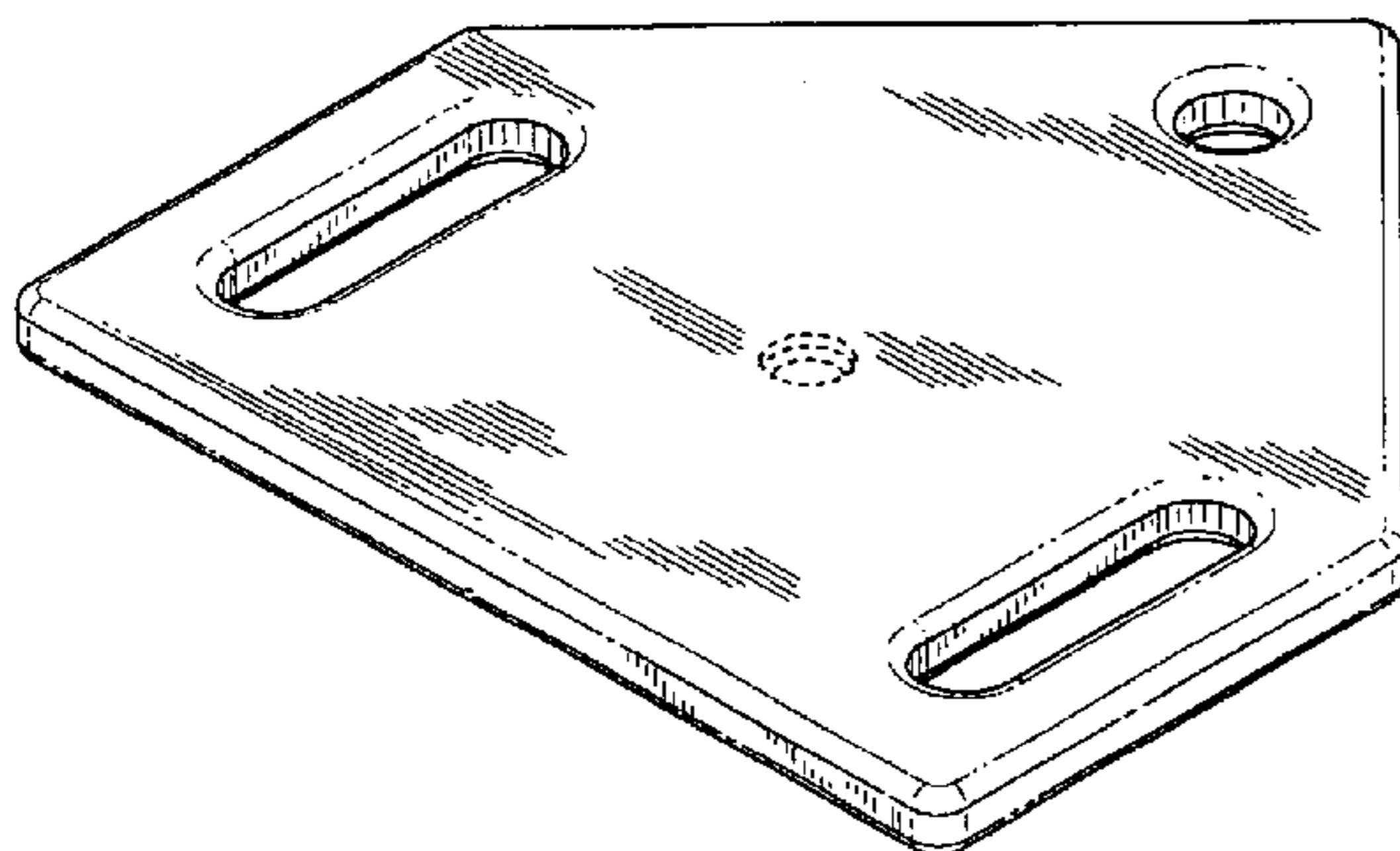

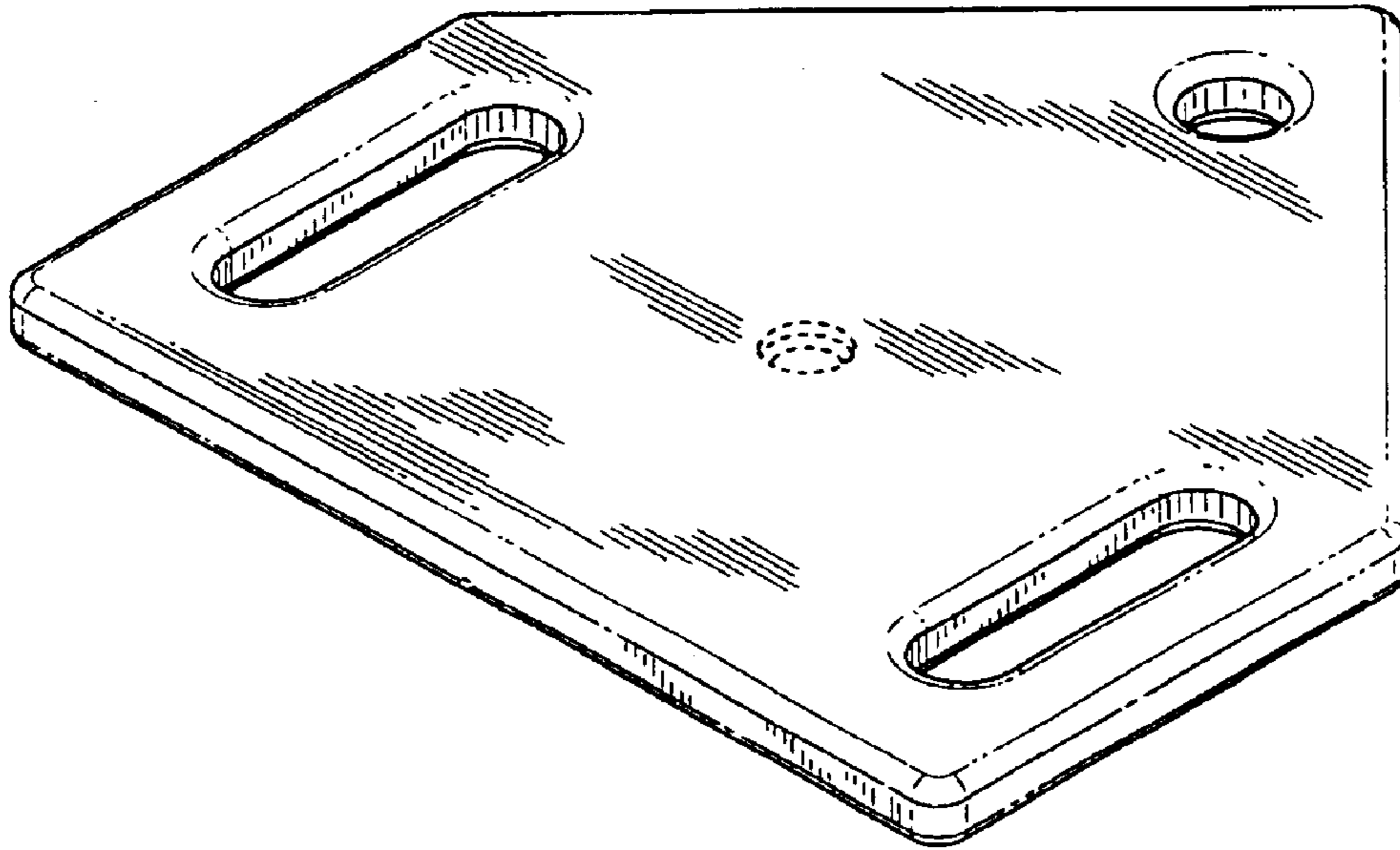

FIG. 1

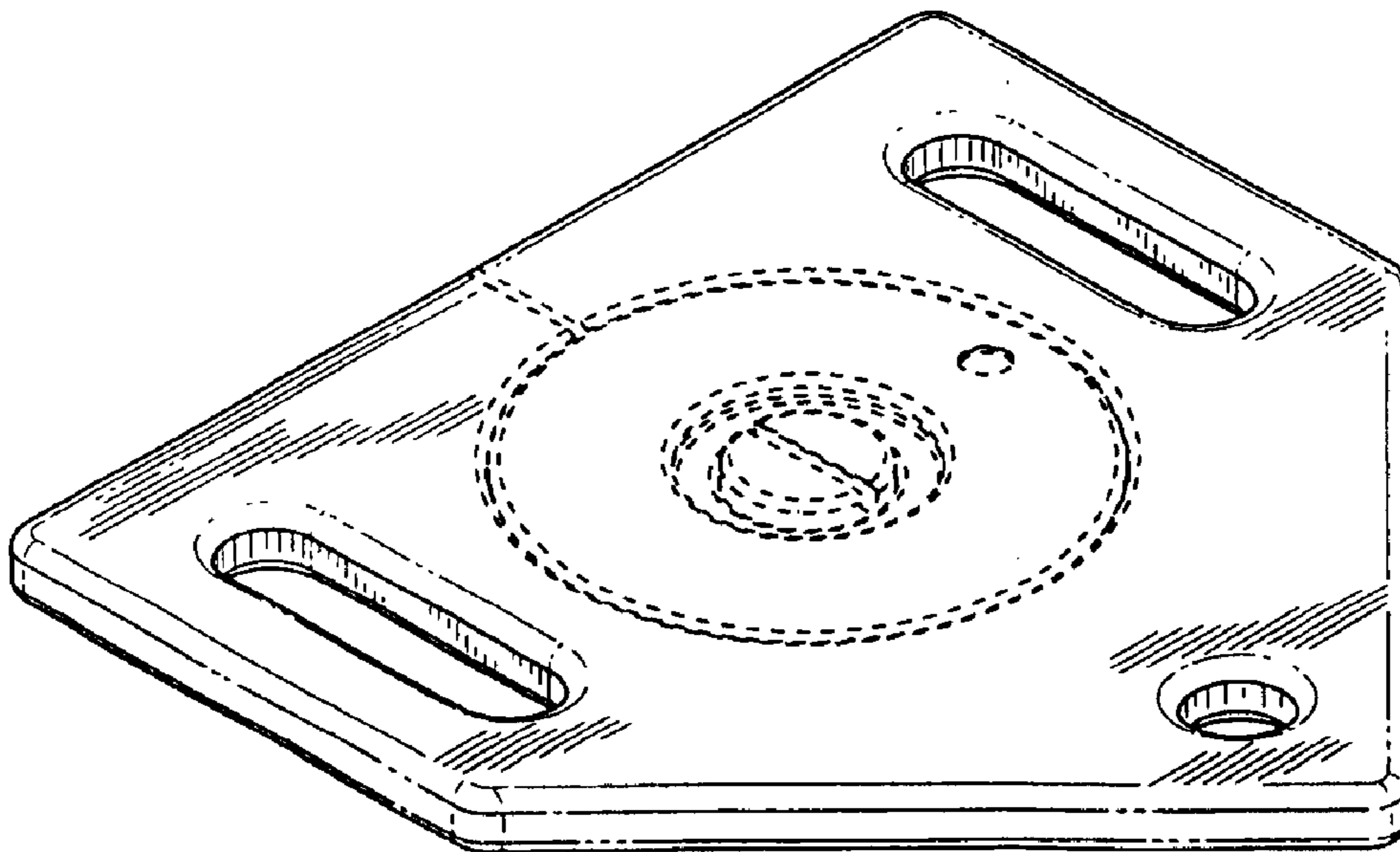

FIG. 2

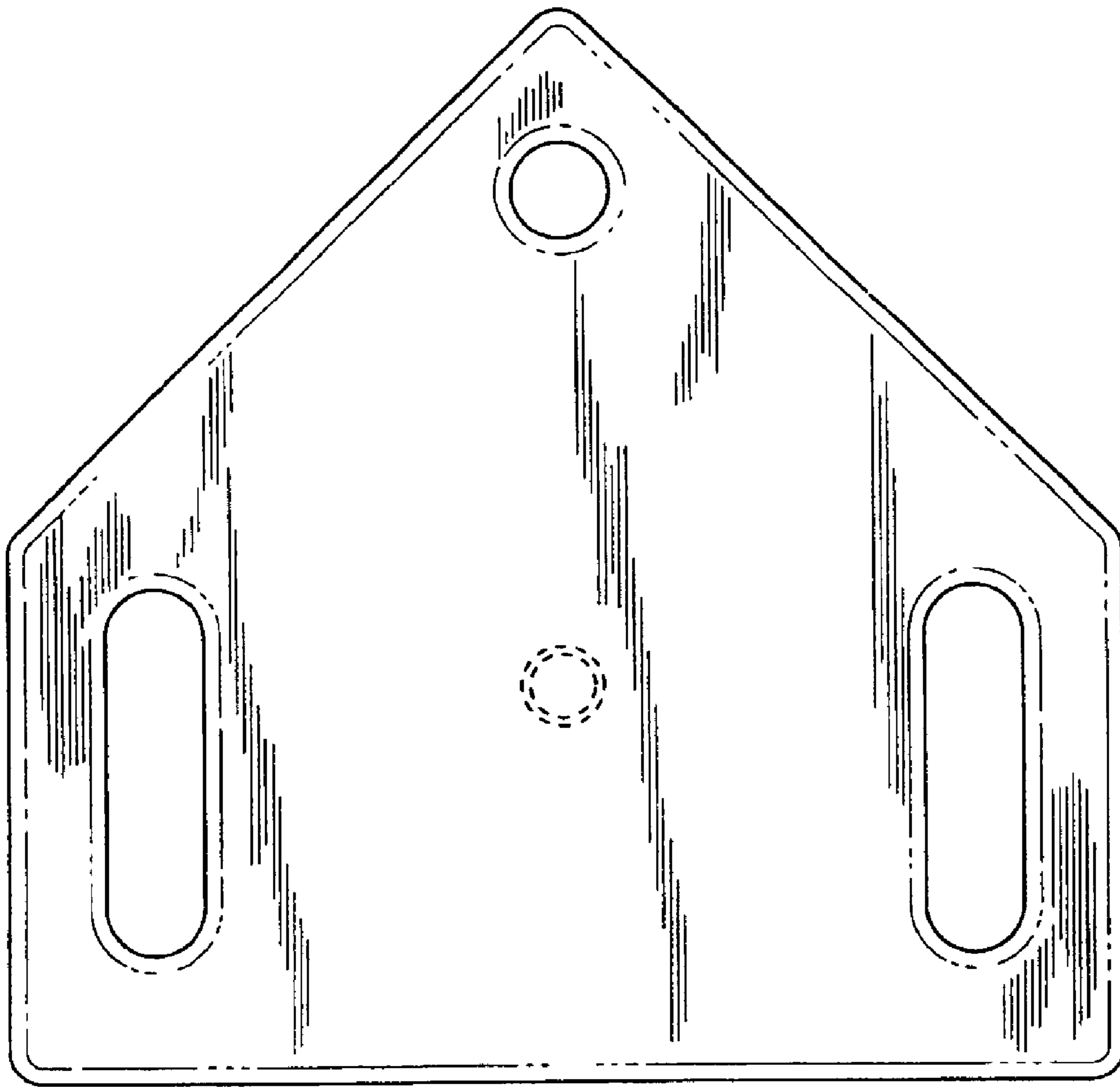

FIG. 3

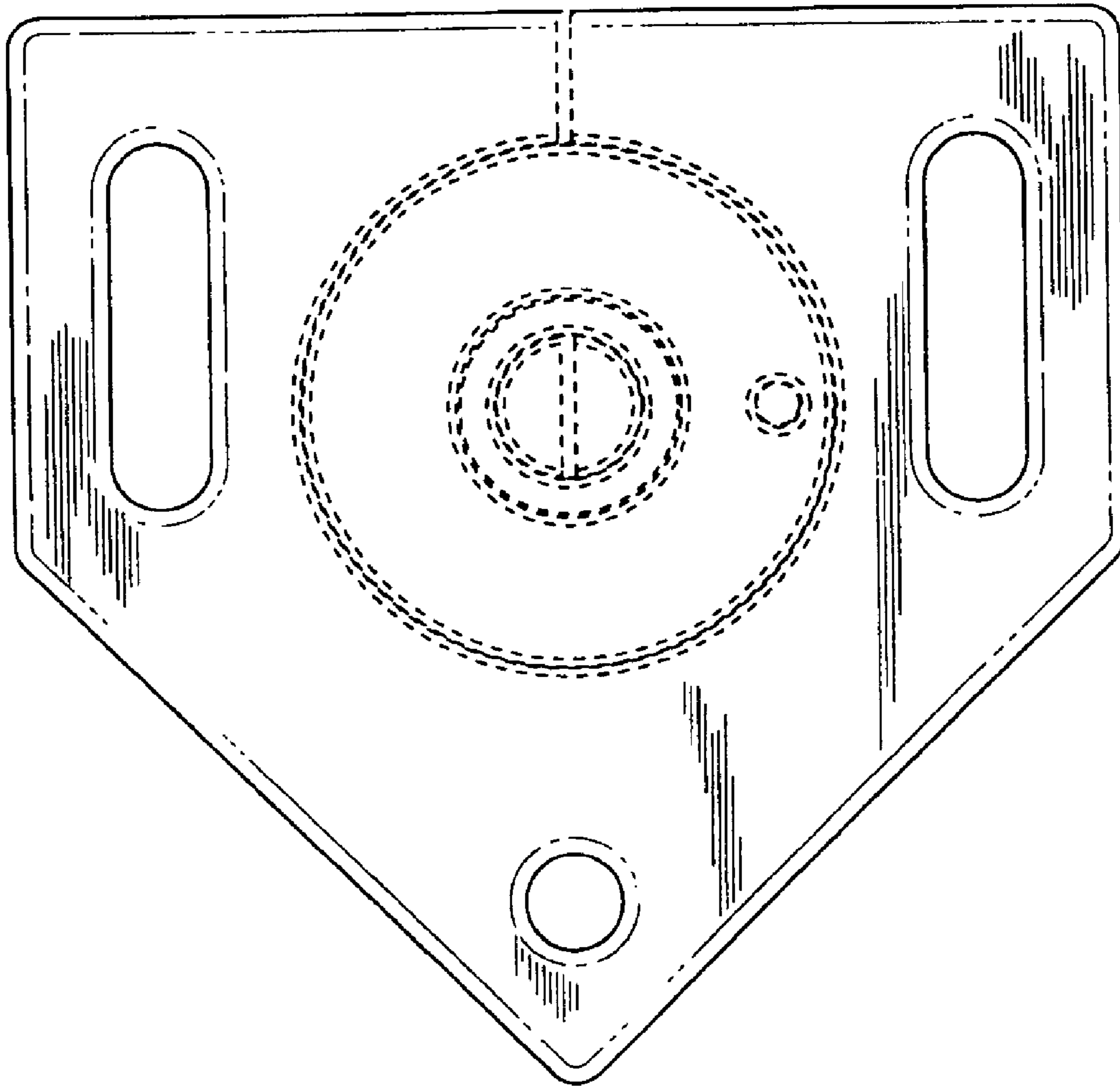

FIG. 4

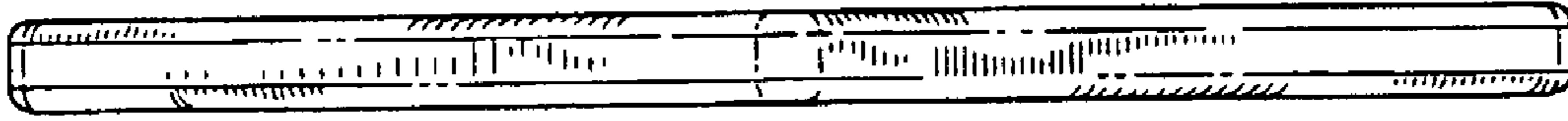

FIG. 5

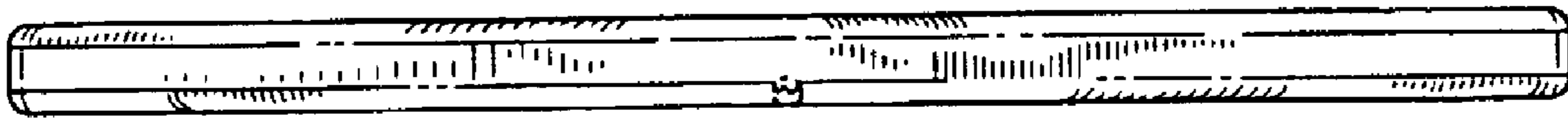

FIG. 6

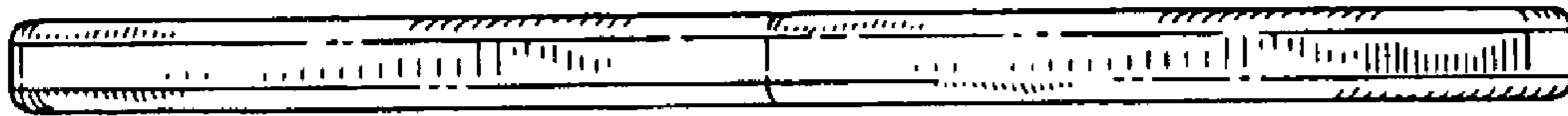

FIG. 7

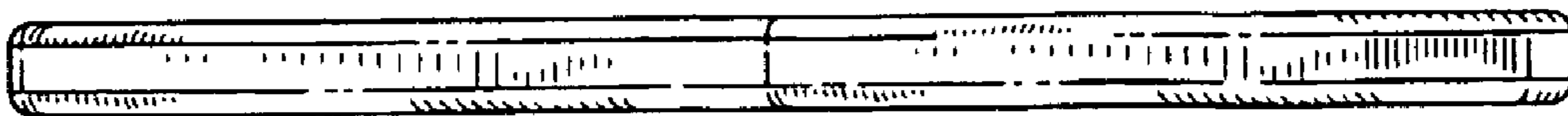

FIG. 8

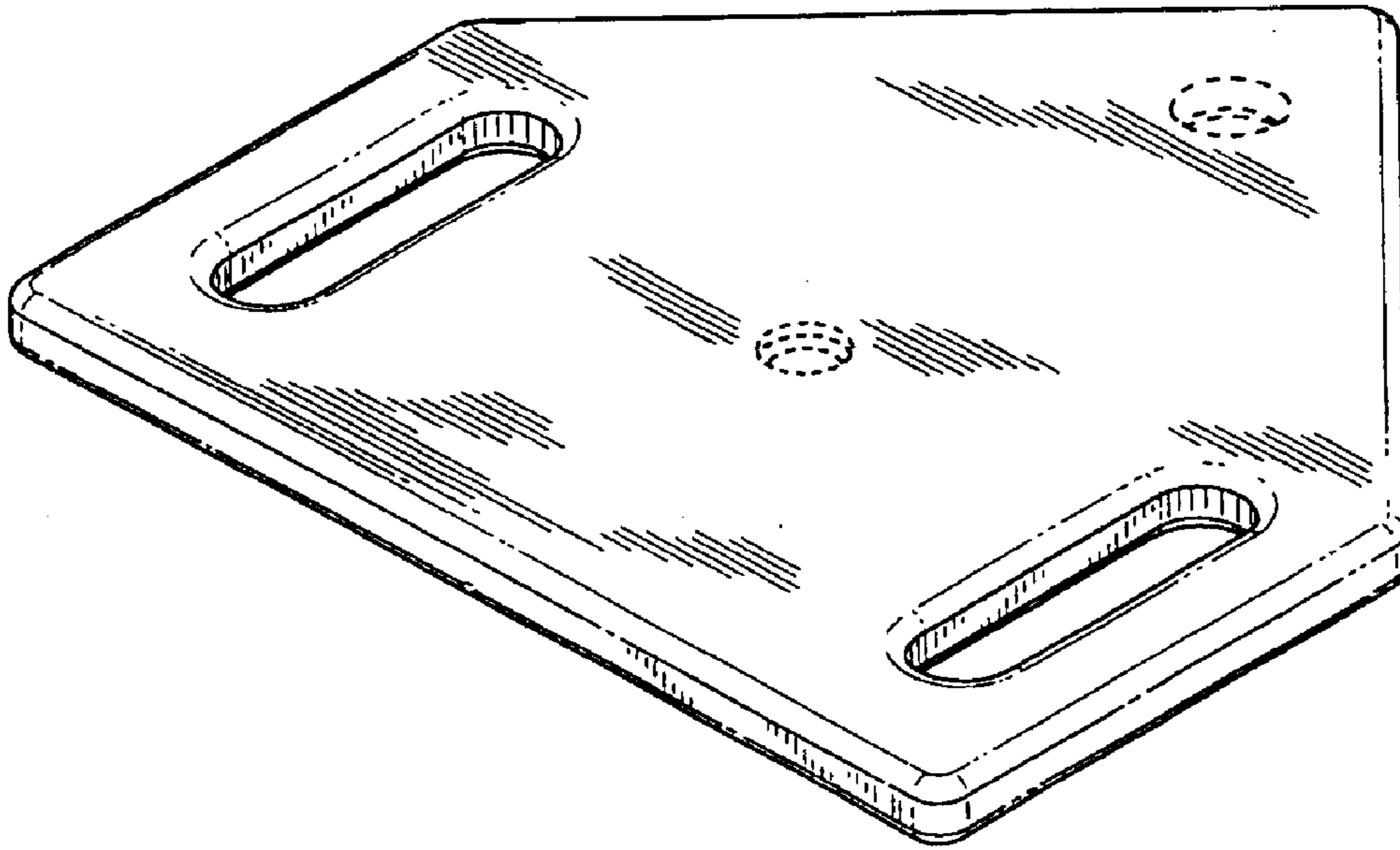

FIG. 9

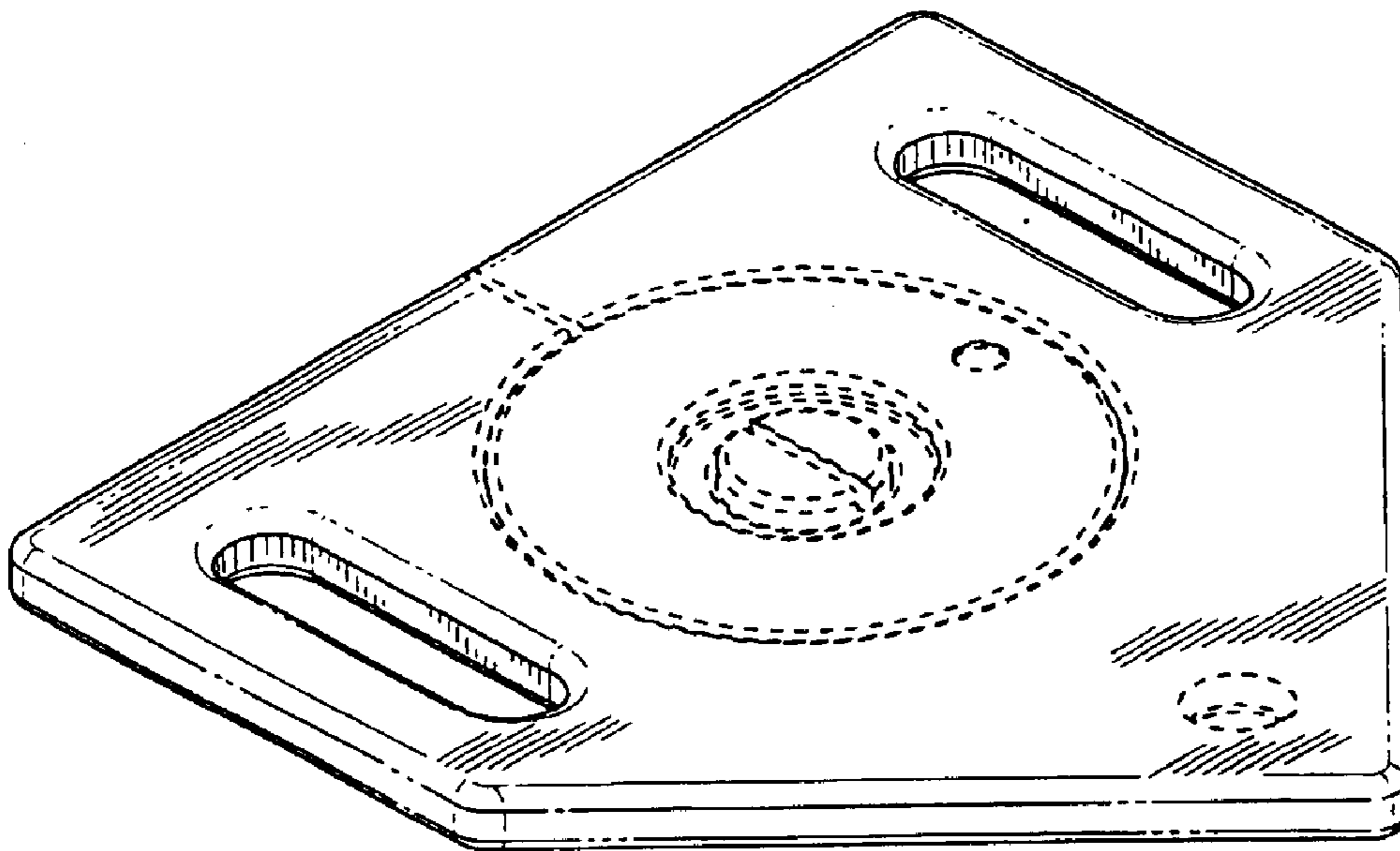

FIG. 10

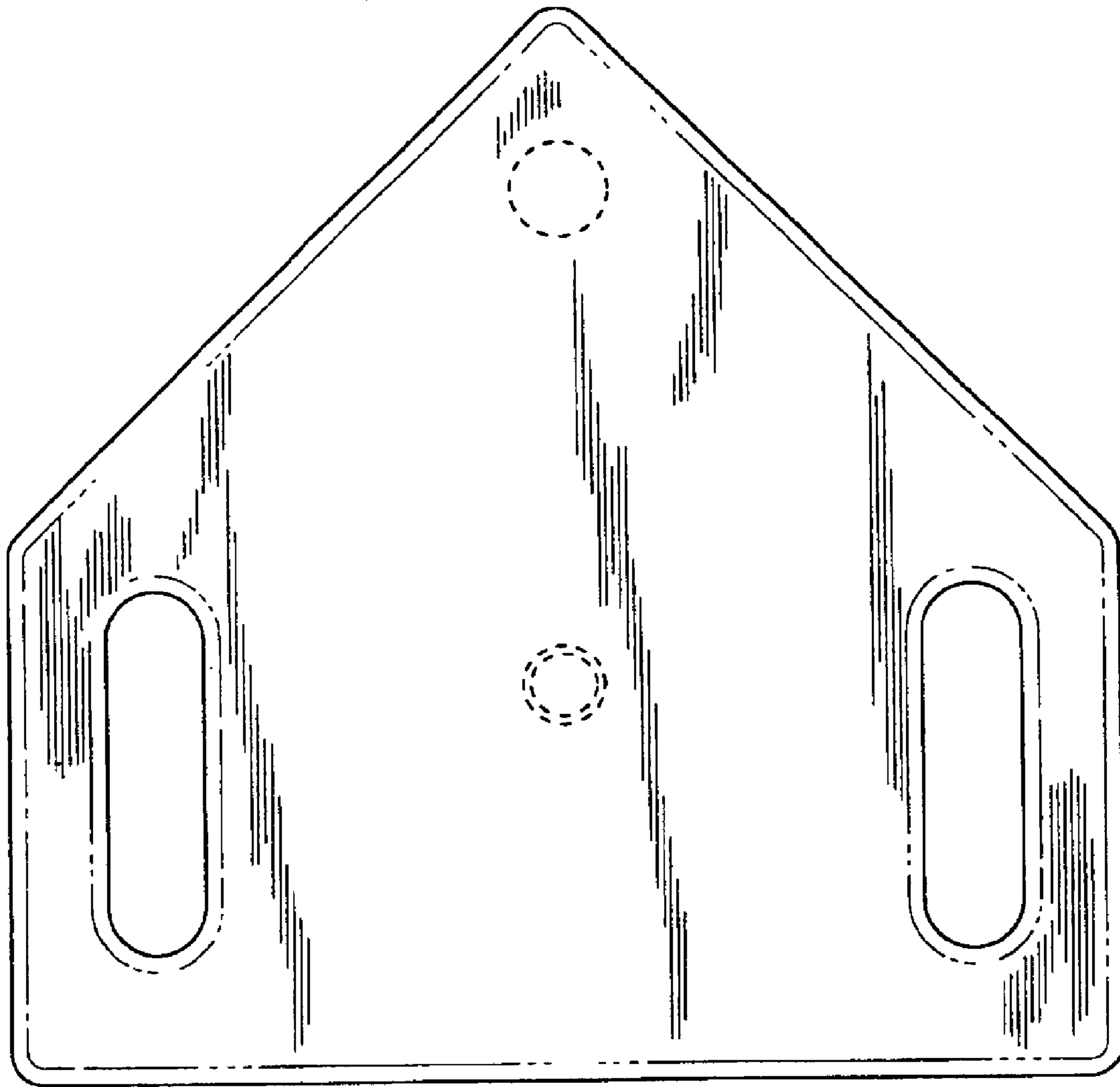

FIG. 11

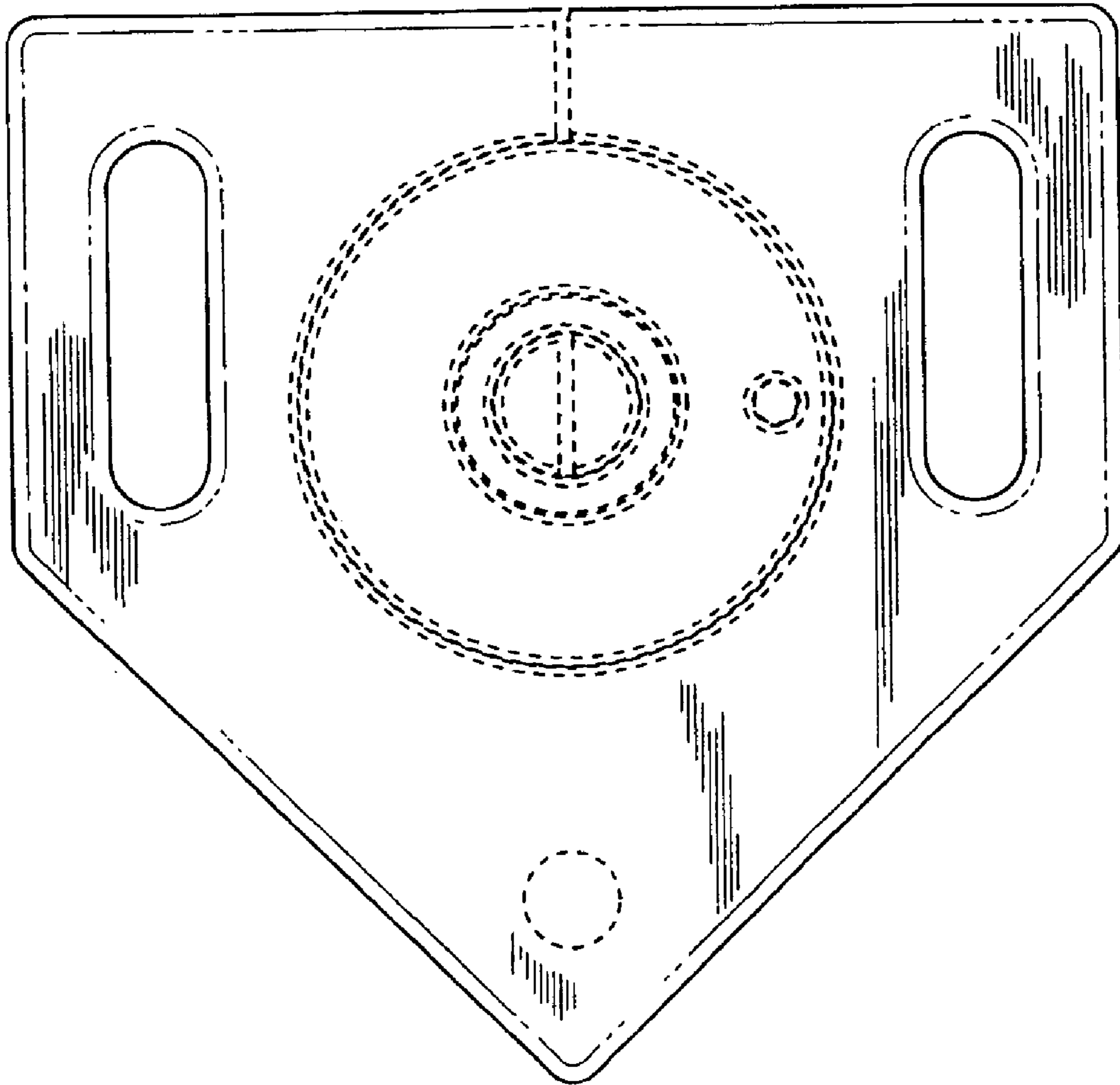

FIG. 12