



US00D528092S

(12) **United States Design Patent**
Lee et al.

(10) **Patent No.:** **US D528,092 S**

(45) **Date of Patent:** **** Sep. 12, 2006**

(54) **CELLULAR PHONE**

(75) Inventors: **Kee-Moon Lee**, Gyeongsangbuk-do (KR); **Chang-Hwan Hwang**, Goyang-si (KR); **Hyun-Seop Kim**, Gunpo-si (KR)

(73) Assignee: **Samsung Electronics Co., Ltd.** (KR)

(**) Term: **14 Years**

(21) Appl. No.: **29/226,600**

(22) Filed: **Mar. 30, 2005**

(30) **Foreign Application Priority Data**

Dec. 7, 2004 (KR) 30-2004-0037483

(51) **LOC (8) Cl.** **14-03**

(52) **U.S. Cl.** **D14/138**

(58) **Field of Classification Search** D14/137, D14/138, 144, 147-148, 247-248, 341-347; D16/208; 379/433.01-433.13; 455/575.4, 455/566, 575.1, 556.1, 556.2, 90.3
See application file for complete search history.

(56) **References Cited**

U.S. PATENT DOCUMENTS

D466,096 S	*	11/2002	Takada	D14/138
D479,215 S	*	9/2003	Yokoyama	D14/138
D497,892 S	*	11/2004	Peng	D14/138
D498,736 S	*	11/2004	Lee	D14/138
D498,737 S	*	11/2004	Park et al.	D14/138
6,822,871 B1	*	11/2004	Lee et al.	361/727
D500,992 S	*	1/2005	Shen et al.	D14/138
D502,162 S	*	2/2005	Kim et al.	D14/138
D502,454 S	*	3/2005	Lee	D14/138
D503,164 S	*	3/2005	Park et al.	D14/138
D508,240 S	*	8/2005	Lee et al.	D14/138
D508,473 S	*	8/2005	Lee et al.	D14/138
D508,688 S	*	8/2005	Lee et al.	D14/138
D511,342 S	*	11/2005	Chien	D14/346
D512,702 S	*	12/2005	Lee et al.	D14/138
D515,060 S	*	2/2006	Lee et al.	D14/138
D517,038 S	*	3/2006	Lee et al.	D14/138
2005/0009581 A1	*	1/2005	Im et al.	455/575.4
2005/0020327 A1	*	1/2005	Chung et al.	455/575.3

2005/0107126 A1	*	5/2005	Kim	455/565
2005/0124394 A1	*	6/2005	Kim et al.	455/575.3
2005/0233708 A1	*	10/2005	Im et al.	455/90.3
2005/0245295 A1	*	11/2005	Lee et al.	455/575.1
2005/0245297 A1	*	11/2005	Lee et al.	455/575.4
2005/0250532 A1	*	11/2005	Hwang et al.	455/550.1
2005/0255897 A1	*	11/2005	Lee et al.	455/575.4
2005/0266897 A1	*	12/2005	Ahn et al.	455/575.1

OTHER PUBLICATIONS

“Samsung D500”, 3 pp including photo, [online], <URL:www.gsmarena.com/samsung_d500-900.php>, site visited Mar. 12, 2006.*

“Samsung D600”, 2 pp including photo, [online], <URL:www.gsmarena.com/samsung_d600-1103.php>, site visited Mar. 12, 2006.*

“Samsung D630”, 2 pp including photo, [online], <URL:www.gsmarena.com/samsung_e360-932.php>, site visited Mar. 12, 2006.*

“Samsung D870”, 2 pp including photo, [online], <URL:www.gsmarena.com/samsung_d870-1506.php>, site visited Mar. 12, 2006.*

* cited by examiner

Primary Examiner—Jeffrey Asch

Assistant Examiner—Carla Jobe Wright

(74) *Attorney, Agent, or Firm*—Cantor Colburn LLP

(57) **CLAIM**

I claim, the ornamental design for a cellular phone, as shown and described.

DESCRIPTION

FIG. 1 is a top and front perspective view of a cellular phone, showing our new design;
FIG. 2 is a front elevational view thereof;
FIG. 3 is a rear elevational view thereof;
FIG. 4 is a left side elevational view thereof;
FIG. 5 is a right side elevational view thereof;
FIG. 6 is a top plan view thereof;
FIG. 7 is a bottom plan view thereof; and,
FIG. 8 is a top and front perspective view of the cellular phone in an alternate position.

1 Claim, 4 Drawing Sheets

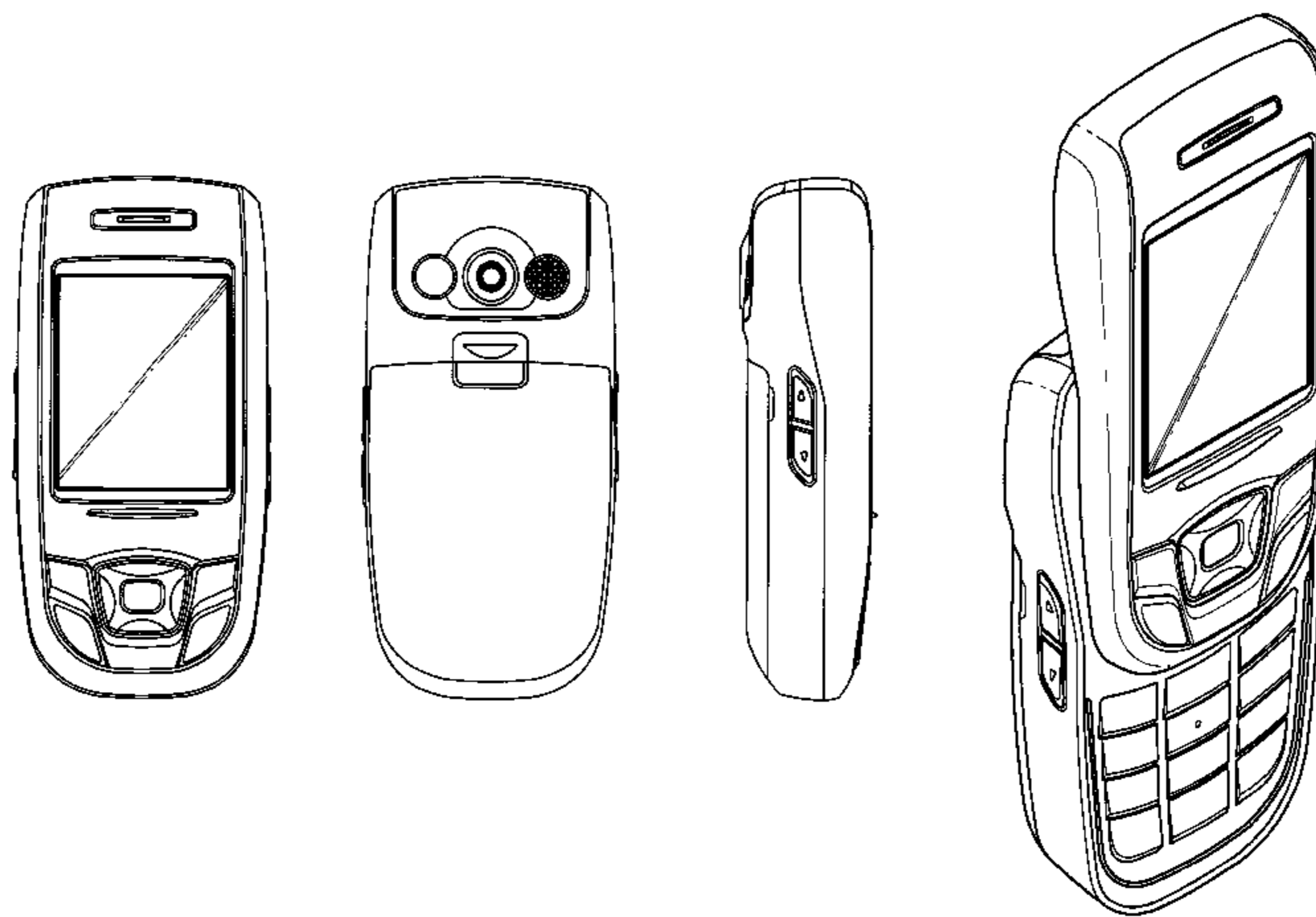

FIG. 1

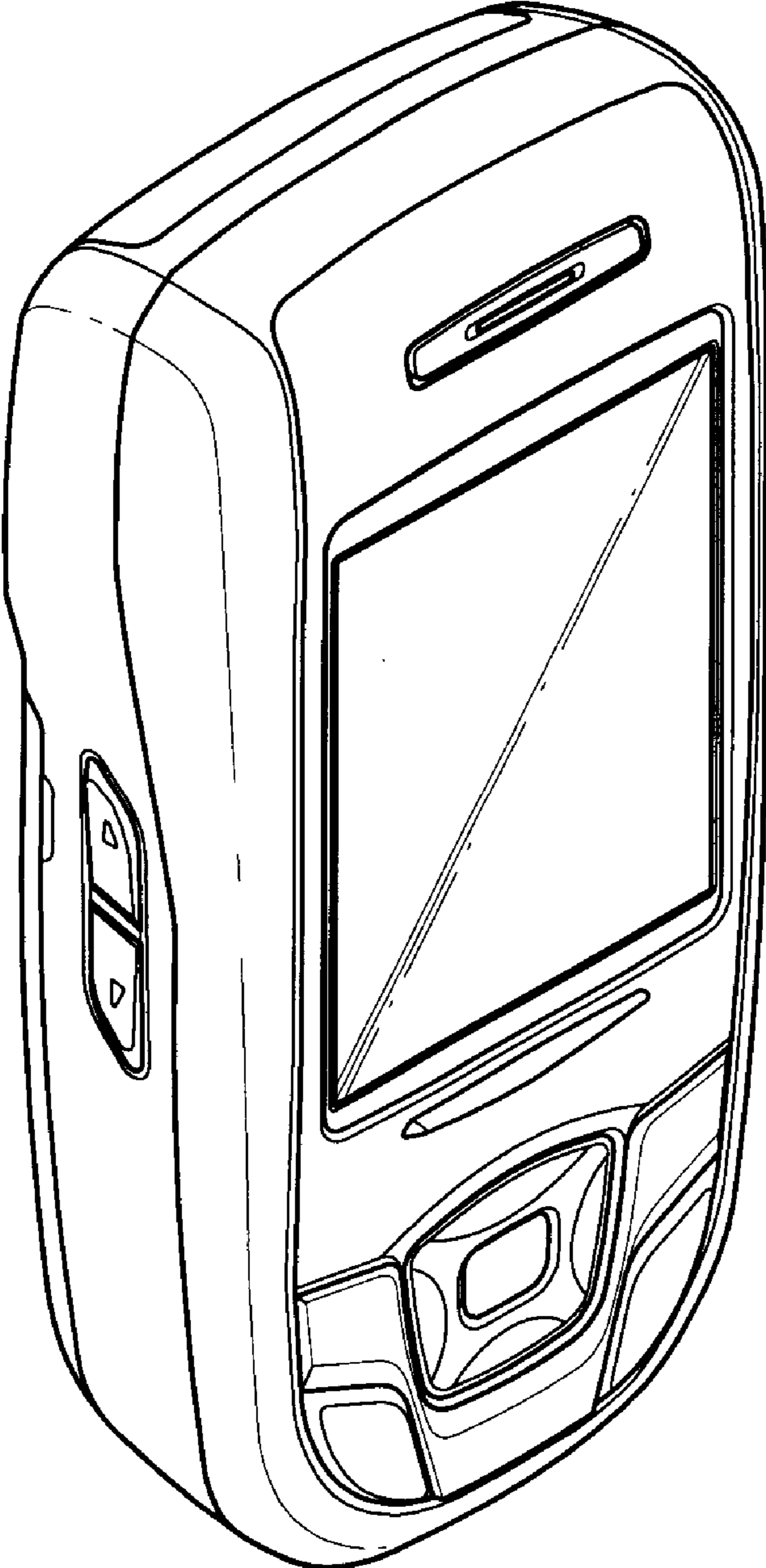

FIG. 2

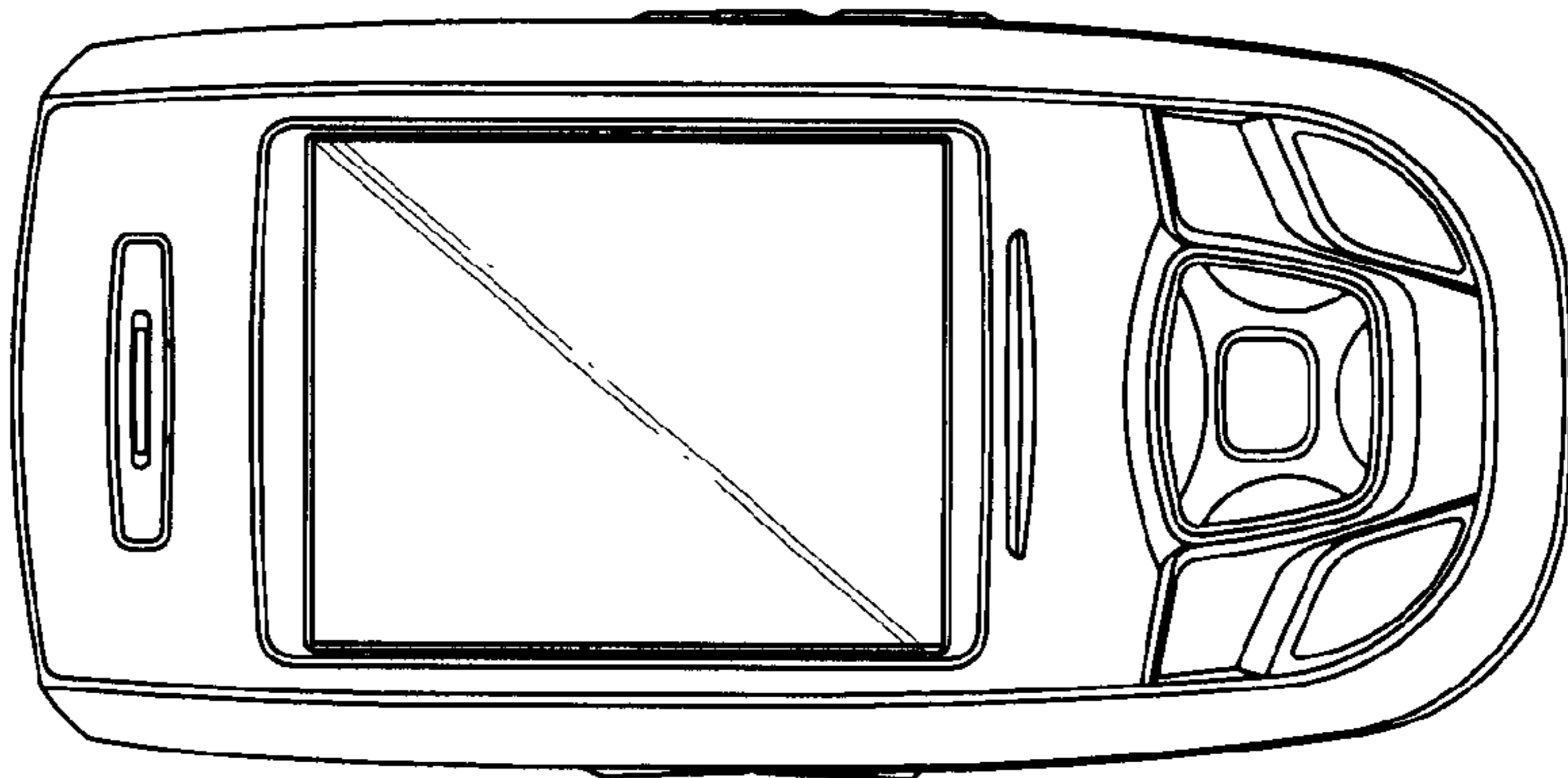

FIG. 3

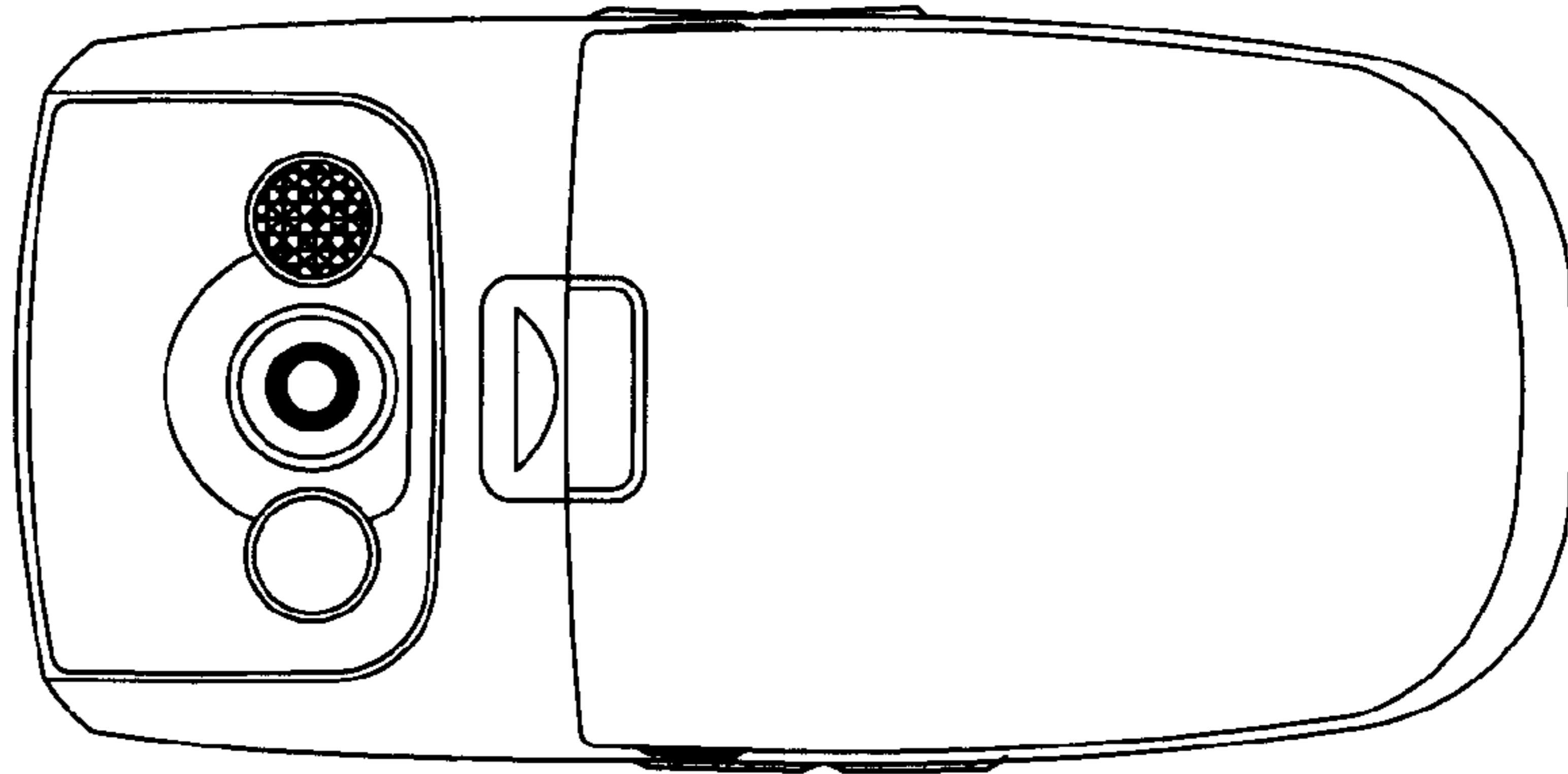

FIG. 4

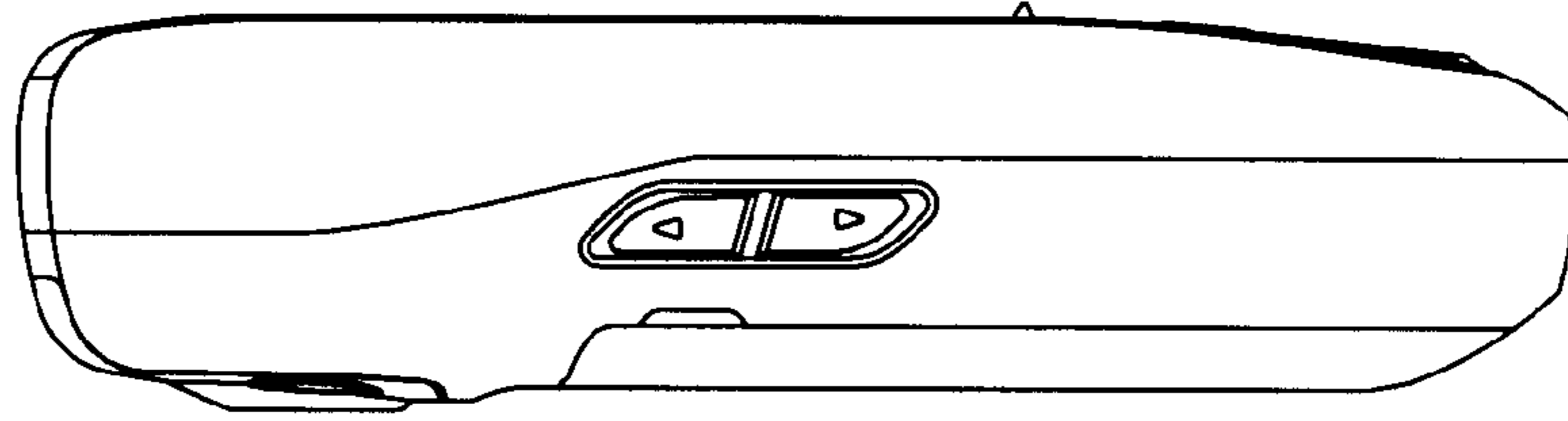

FIG. 5

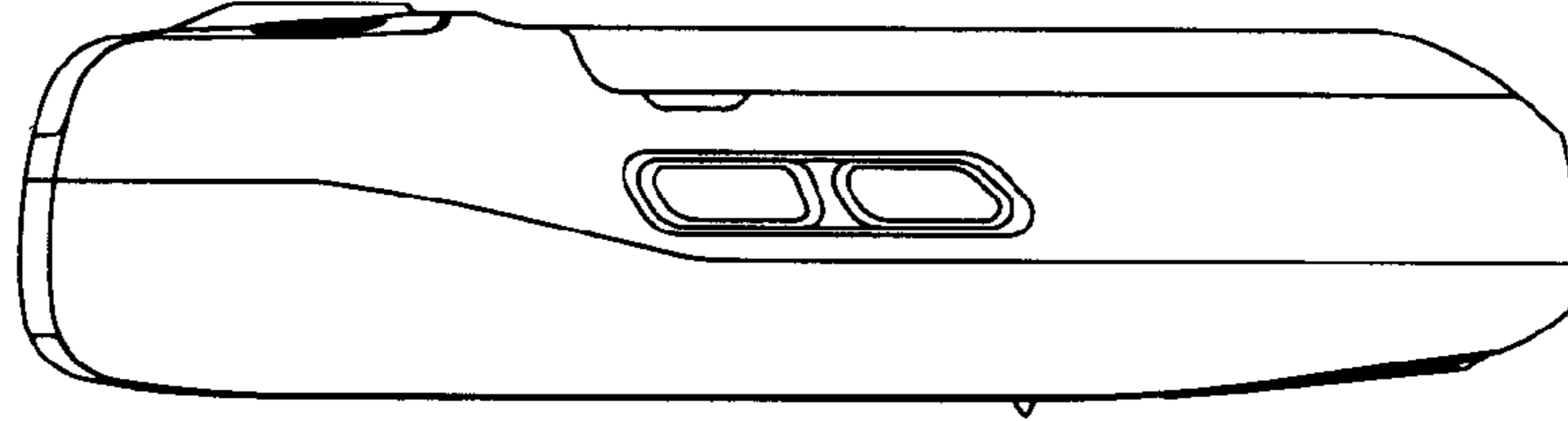

FIG. 6

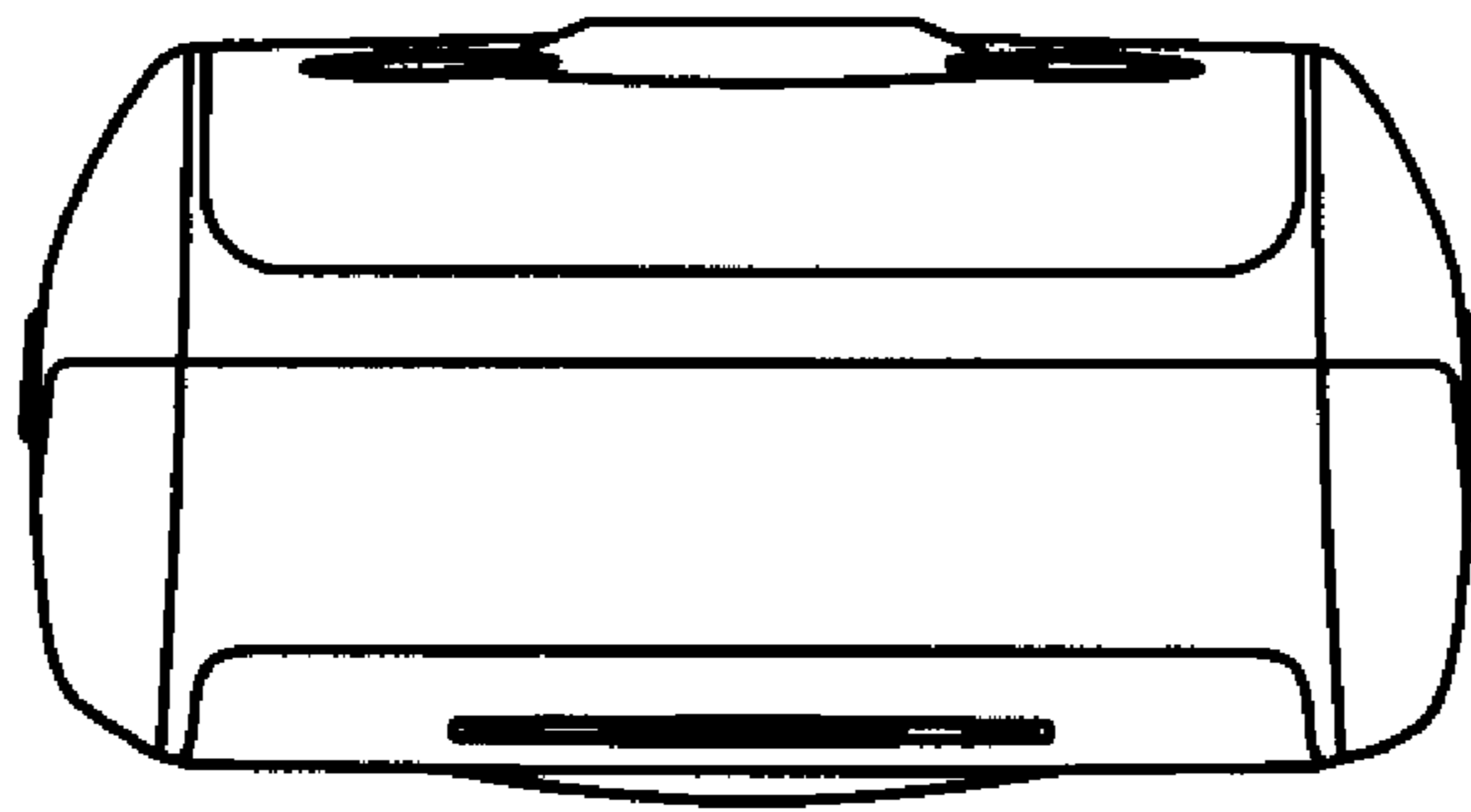

FIG. 7

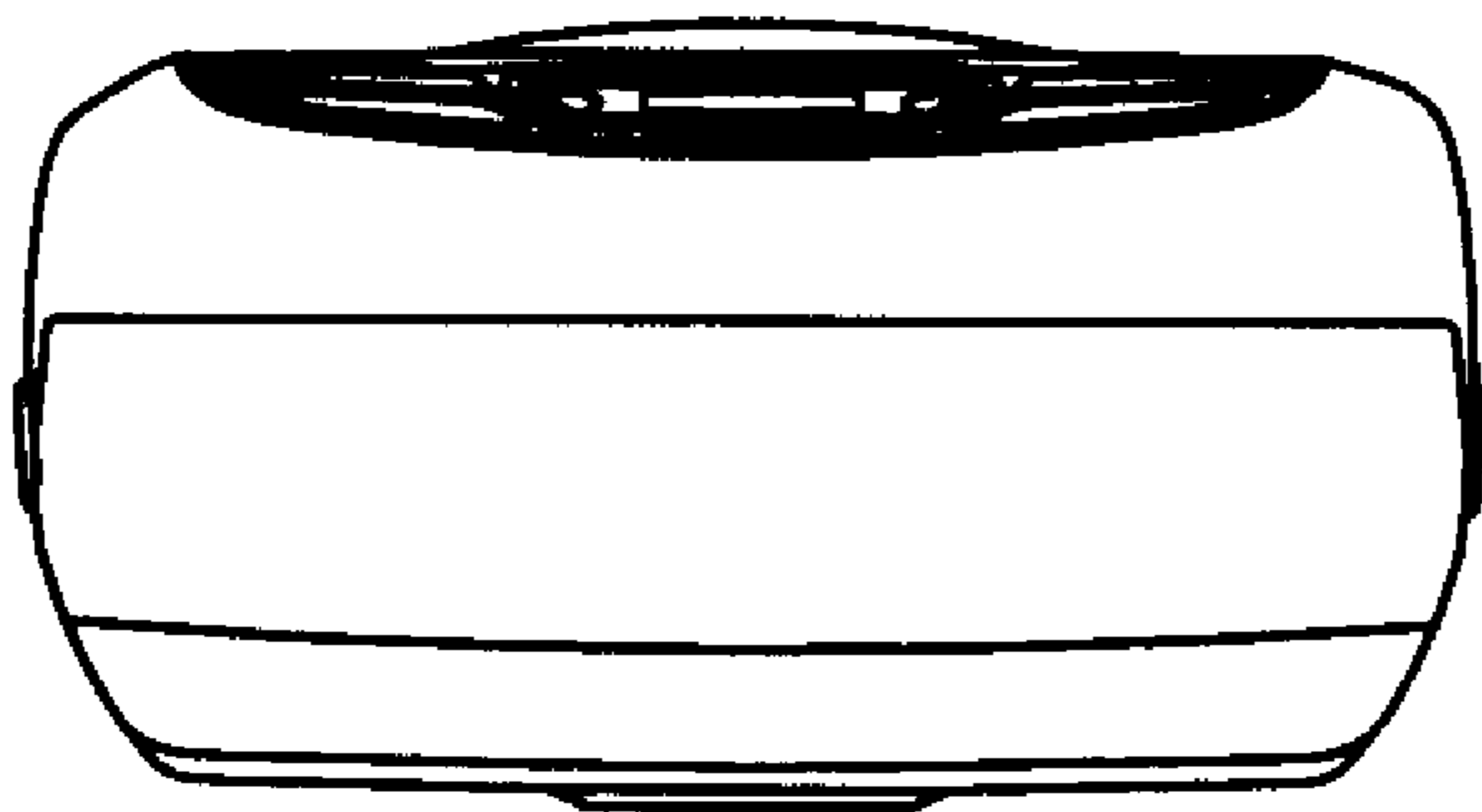

FIG. 8

