



US00D528007S

(12) **United States Design Patent**
De Niverville et al.

(10) **Patent No.: US D528,007 S**

(45) **Date of Patent: ** Sep. 12, 2006**

(54) **BOTTLE WITH HAND GRIP**

(75) Inventors: **Marc-Alain De Niverville**, Toronto (CA); **Nina Leshyk**, Mississauga (CA); **Terence Newman**, Innisfil (CA)

(73) Assignee: **Silgan Plastics Corporation**, Norcross, GA (US)

(**) **Term: 14 Years**

(21) Appl. No.: **29/190,663**

(22) Filed: **Sep. 24, 2003**

(51) **LOC (8) Cl. 09-01**

(52) **U.S. Cl. D9/543**

(58) **Field of Classification Search** D9/434, D9/516, 523, 526-528, 530-531, 534-535, D9/537-543, 558, 570-751; D7/300.1, 312, D7/318, 321, 510-511, 521, 533, 535, 538, D7/543, 612-615, 619.1, 622, 629; 215/381-385, 215/396, 398; 220/669, 752, 771

See application file for complete search history.

(56) **References Cited**

U.S. PATENT DOCUMENTS

| | | | | | |
|-------------|---|--------|-----------------|-------|--------|
| D108,125 S | * | 1/1938 | Lummis | | D9/542 |
| D198,404 S | | 6/1964 | Busch | | |
| D198,407 S | | 6/1964 | Busch | | |
| D207,509 S | * | 4/1967 | Thomka | | D9/528 |
| D258,346 S | * | 2/1981 | Winchell et al. | | D9/543 |
| D325,522 S | * | 4/1992 | Brochenin | | D9/523 |
| D343,093 S | * | 1/1994 | Sabin et al. | | D7/612 |
| D379,763 S | | 6/1997 | Ewing, Jr. | | |
| 5,758,790 A | | 6/1998 | Ewing, Jr. | | |
| D411,804 S | * | 7/1999 | Zaragoza | | D9/540 |
| D423,936 S | * | 5/2000 | Smith et al. | | D9/520 |

| | | | | | |
|--------------|---|---------|---------------------|-------|---------|
| D428,815 S | * | 8/2000 | Mooney et al. | | D9/539 |
| D442,866 S | * | 5/2001 | Mooney et al. | | D9/537 |
| D444,710 S | | 7/2001 | Zboch et al. | | |
| D446,457 S | | 8/2001 | Krishnakumar et al. | | |
| D448,672 S | | 10/2001 | Cheng et al. | | |
| D448,674 S | * | 10/2001 | Mooney | | D9/543 |
| D449,538 S | | 10/2001 | Burleson et al. | | |
| D454,501 S | | 3/2002 | Tornaletti et al. | | |
| 6,390,316 B1 | | 5/2002 | Mooney | | |
| D458,541 S | | 6/2002 | Steiger et al. | | |
| 6,439,413 B1 | * | 8/2002 | Prevot et al. | | 215/381 |
| D473,794 S | * | 4/2003 | Ouillette et al. | | D9/523 |
| D496,281 S | * | 9/2004 | Trude | | D9/540 |

* cited by examiner

Primary Examiner—Ian Simmons

Assistant Examiner—Dana Sipos

(57) **CLAIM**

The ornamental design for a bottle with hand grip, as shown and described.

DESCRIPTION

FIG. 1 is a right side elevational view of a bottle with hand grip showing our new design;

FIG. 2 is a bottom plan view thereof;

FIG. 3 is a rear elevational view thereof;

FIG. 4 is a front elevational view thereof;

FIG. 5 is a top plan view thereof;

FIG. 6 is cross sectional view thereof along the line 6—6 of FIG. 1; and,

FIG. 7 is a top, front, left side perspective view thereof shown at a reduced scale.

The broken lines in the drawings are for illustrative purposes only and form no part of the claimed design.

1 Claim, 3 Drawing Sheets

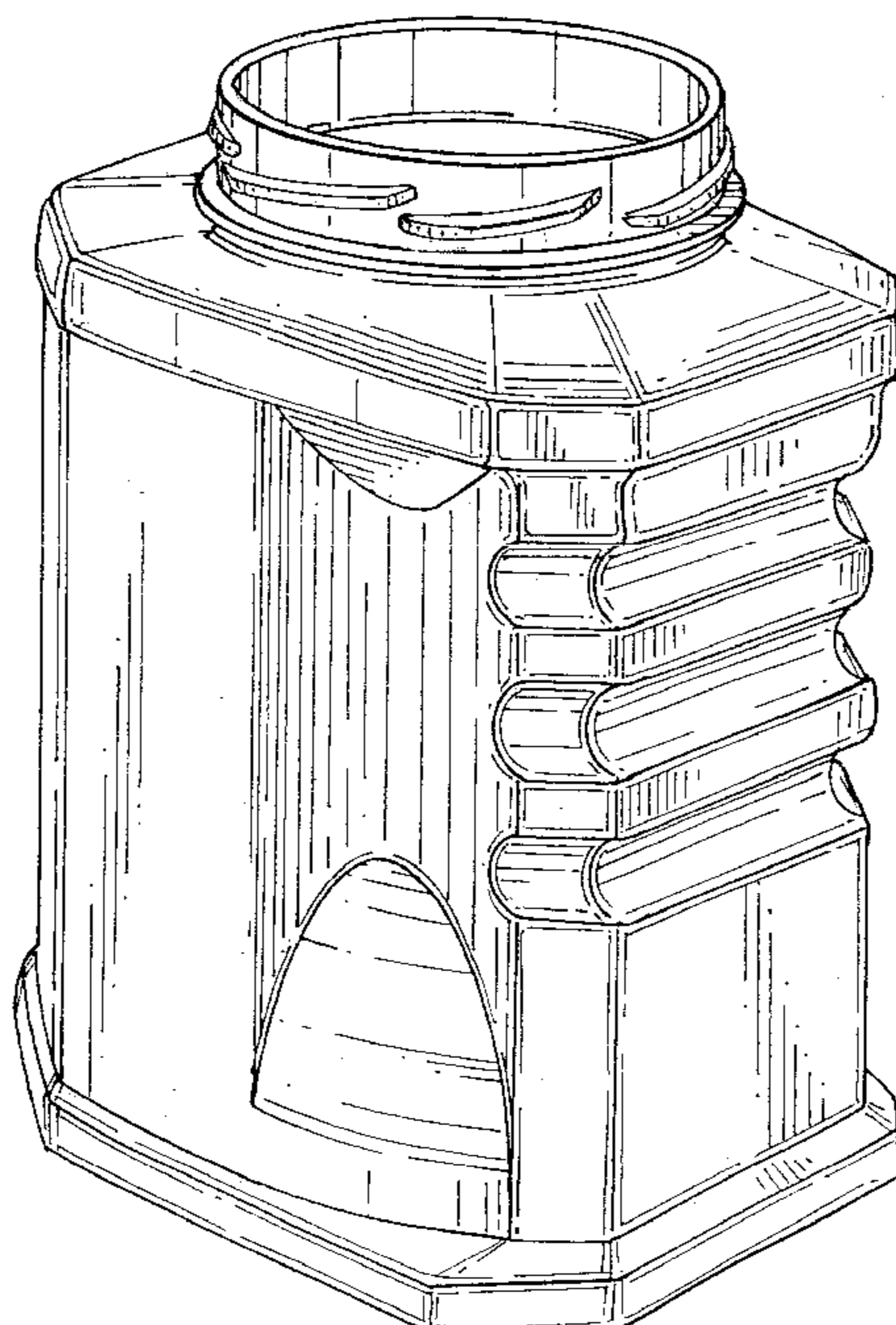

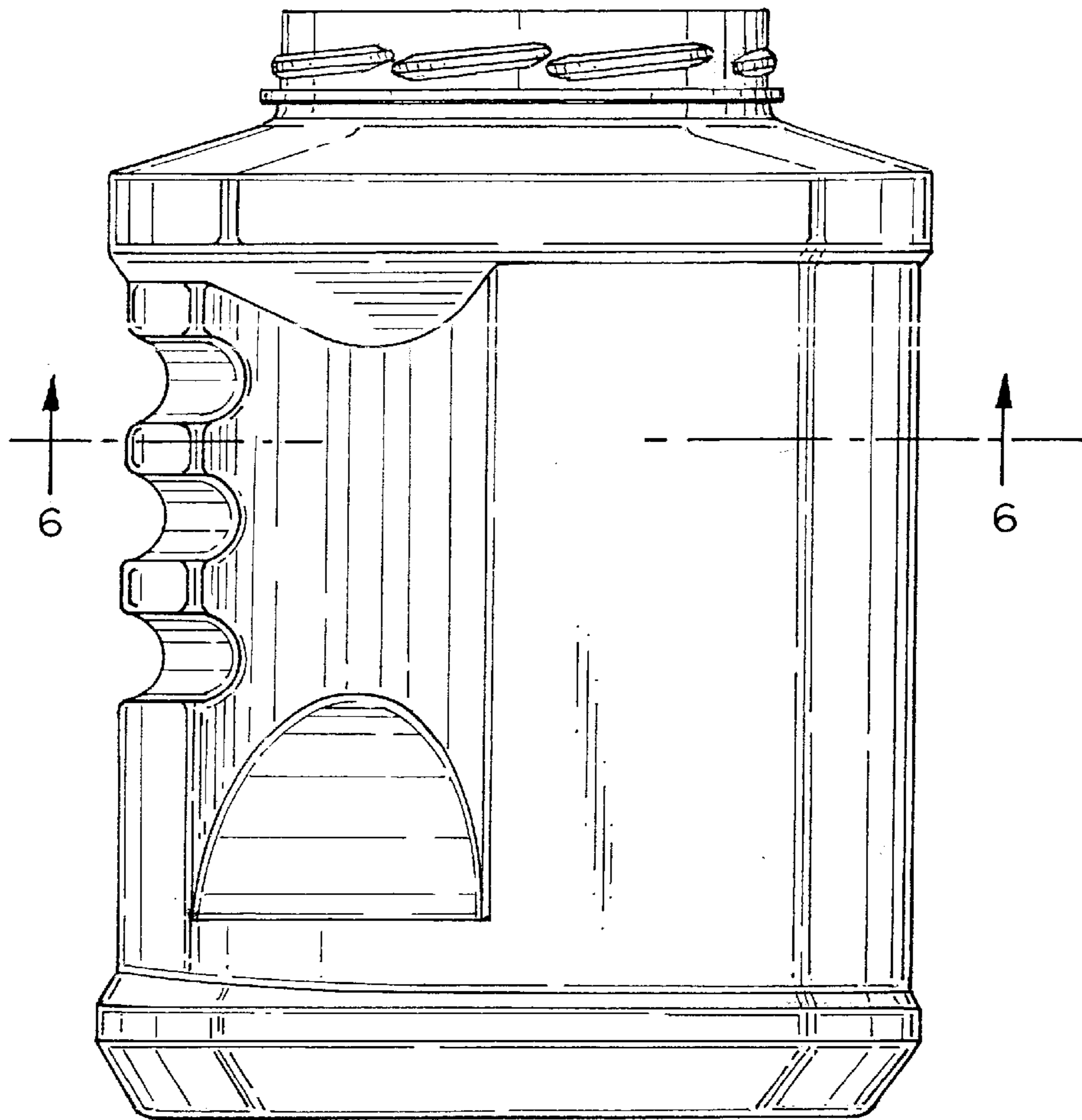

FIG. 1

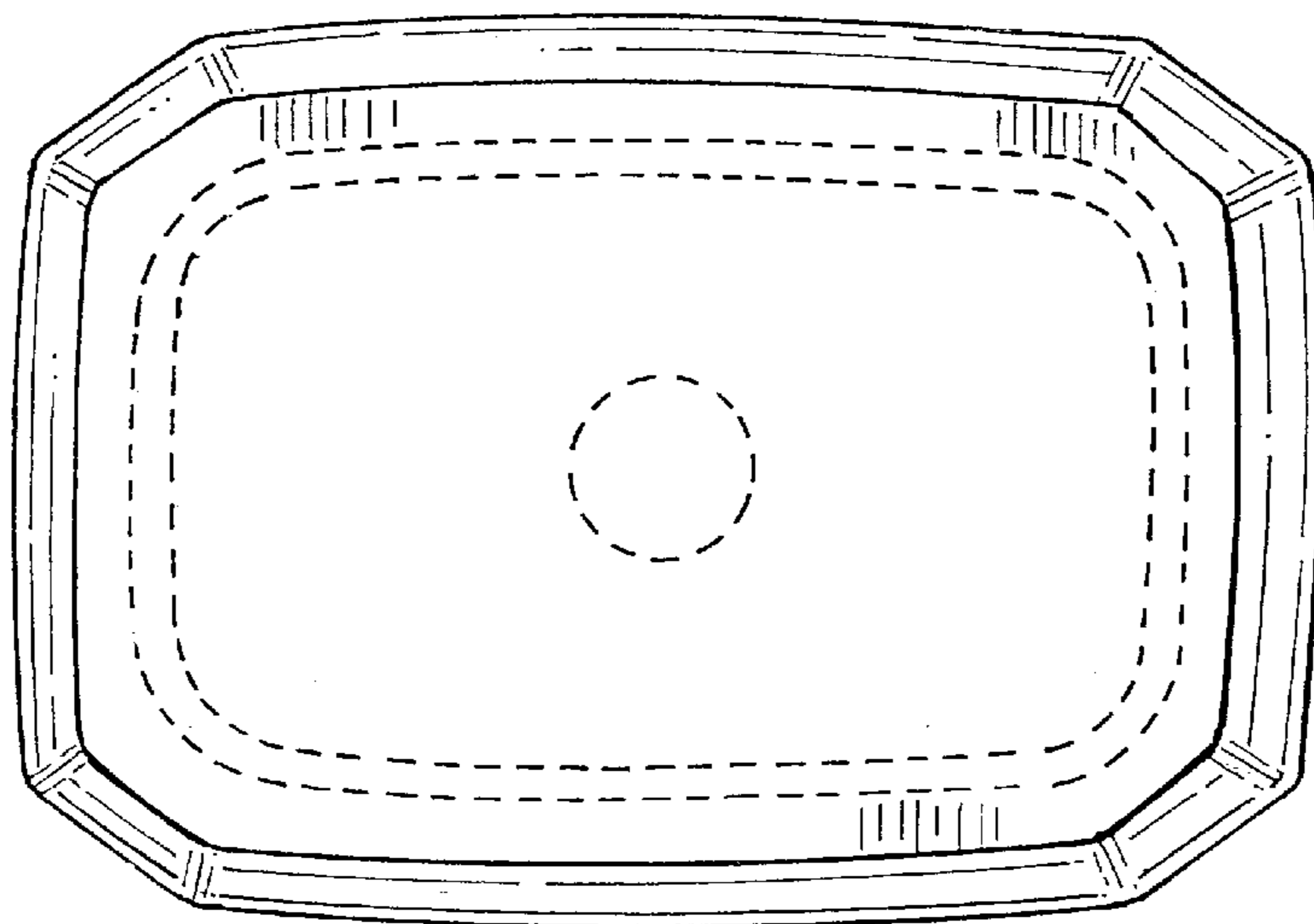

FIG. 2

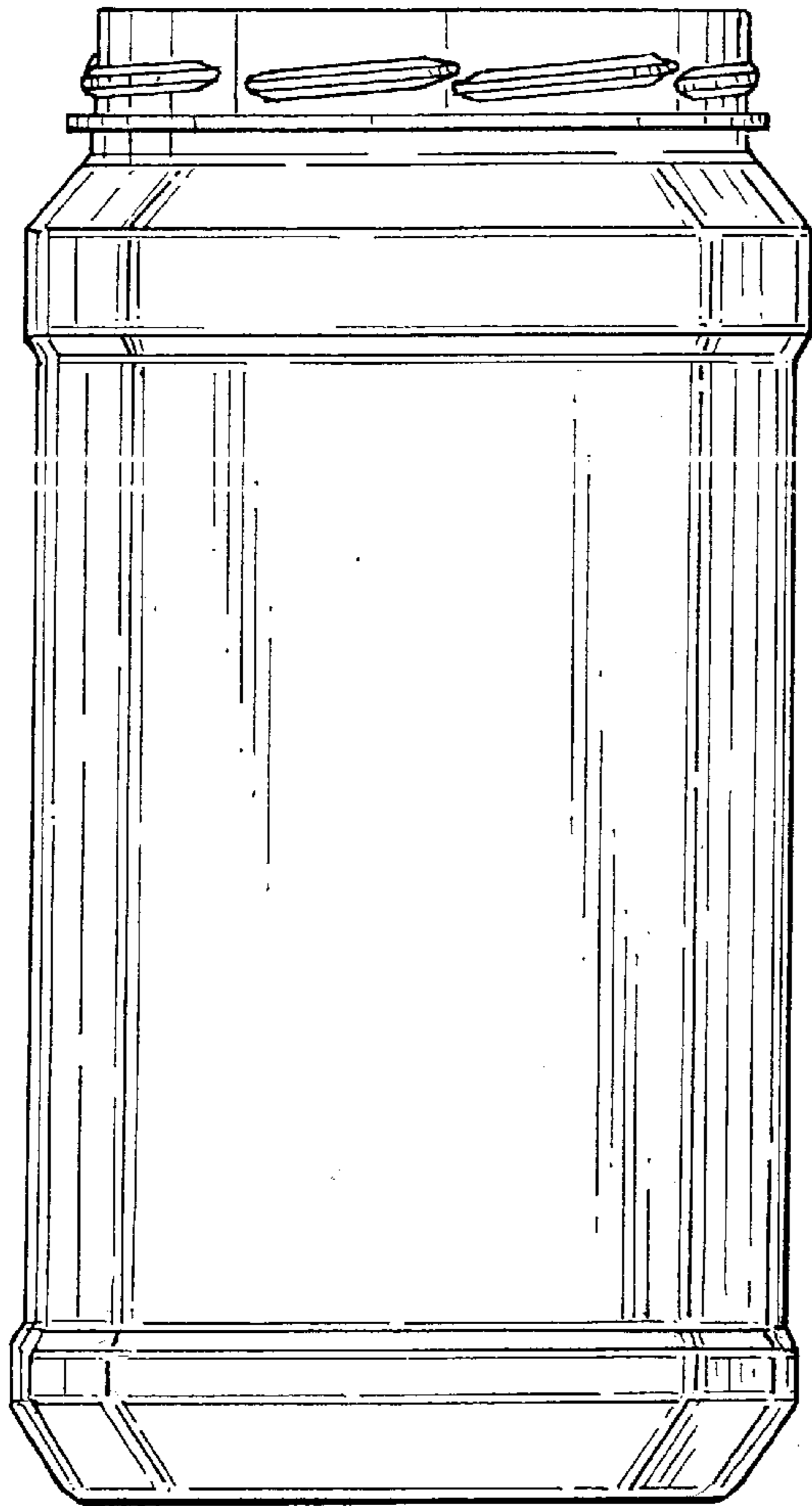

FIG. 3

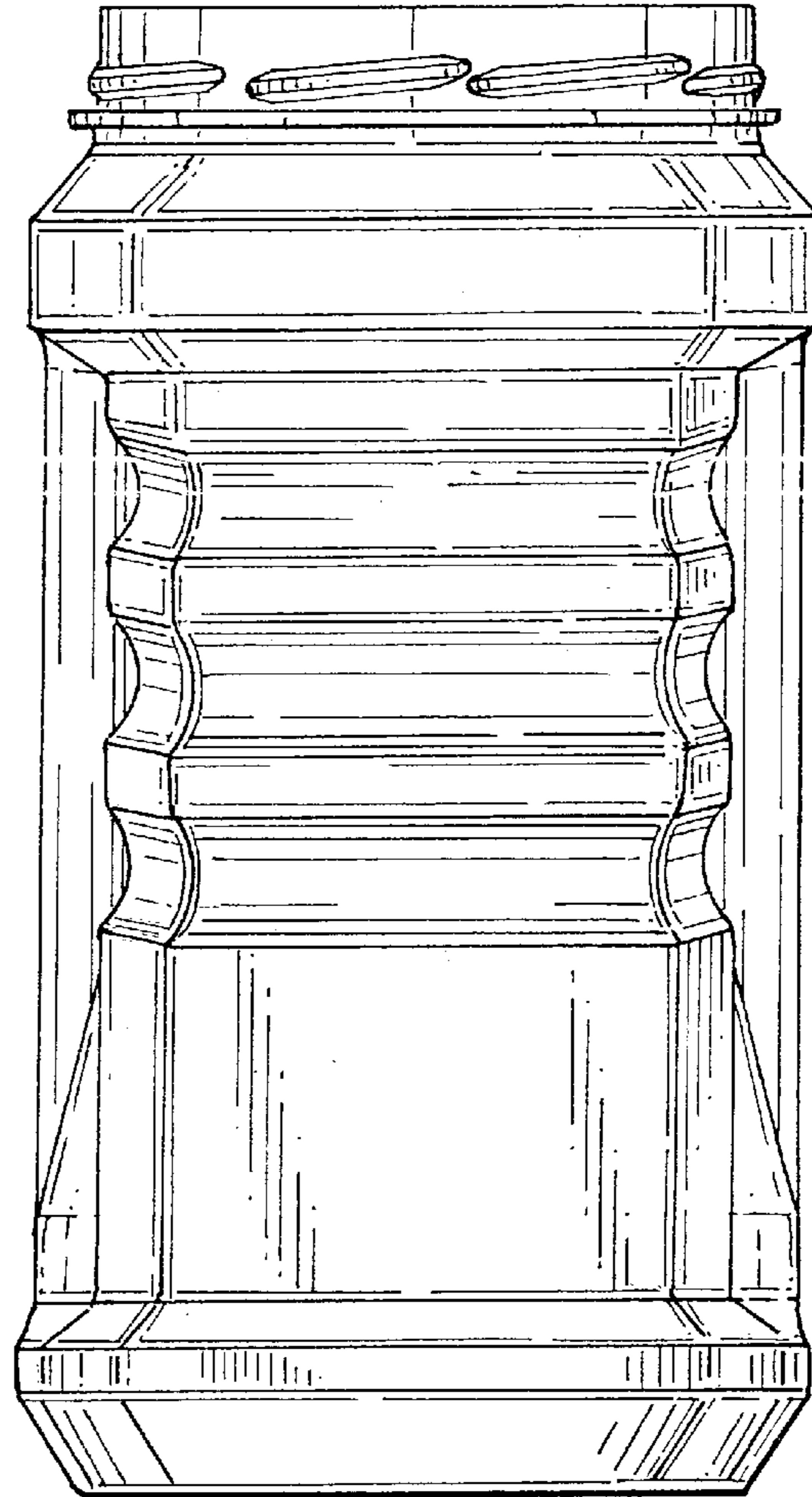

FIG. 4

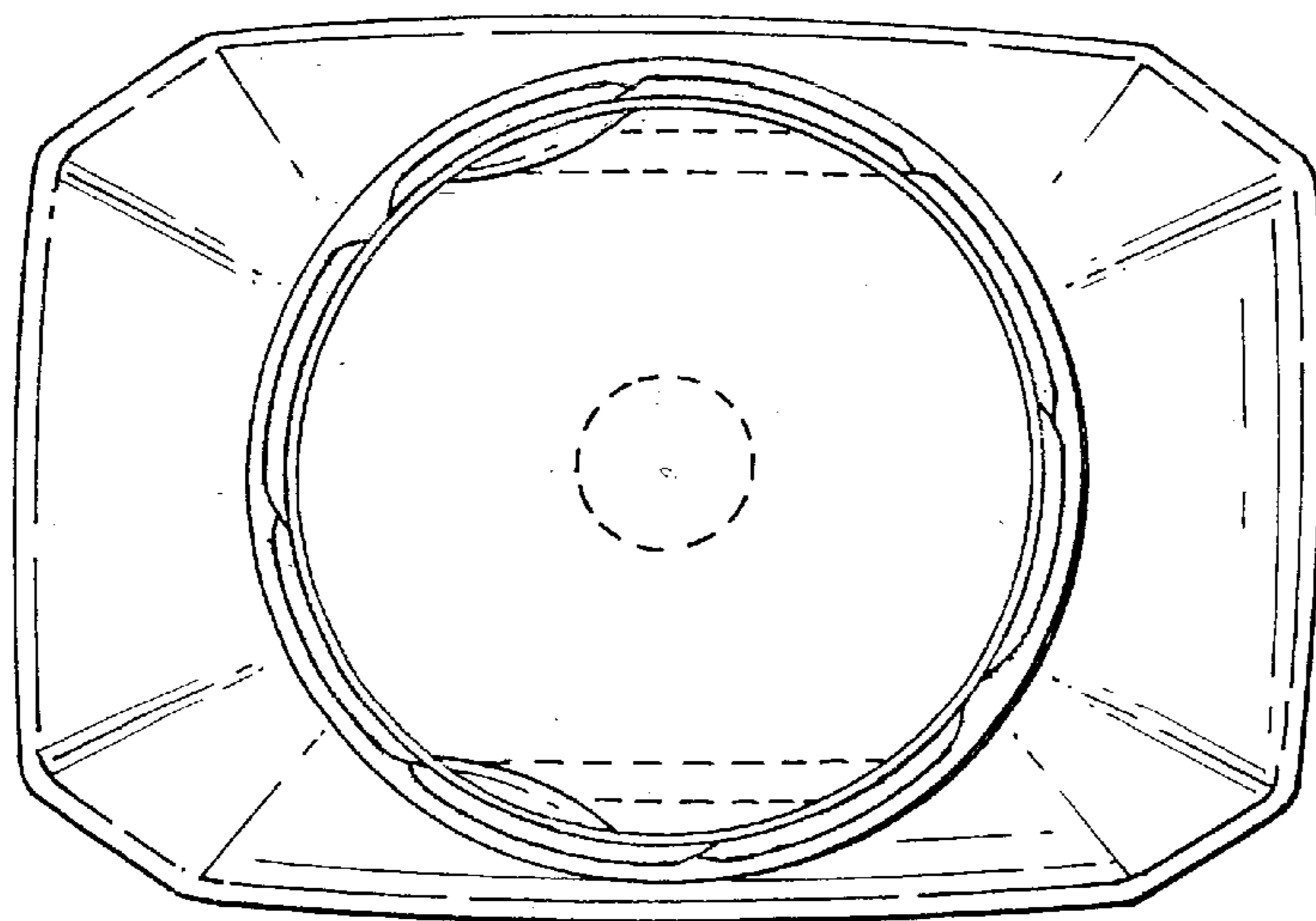

FIG. 5

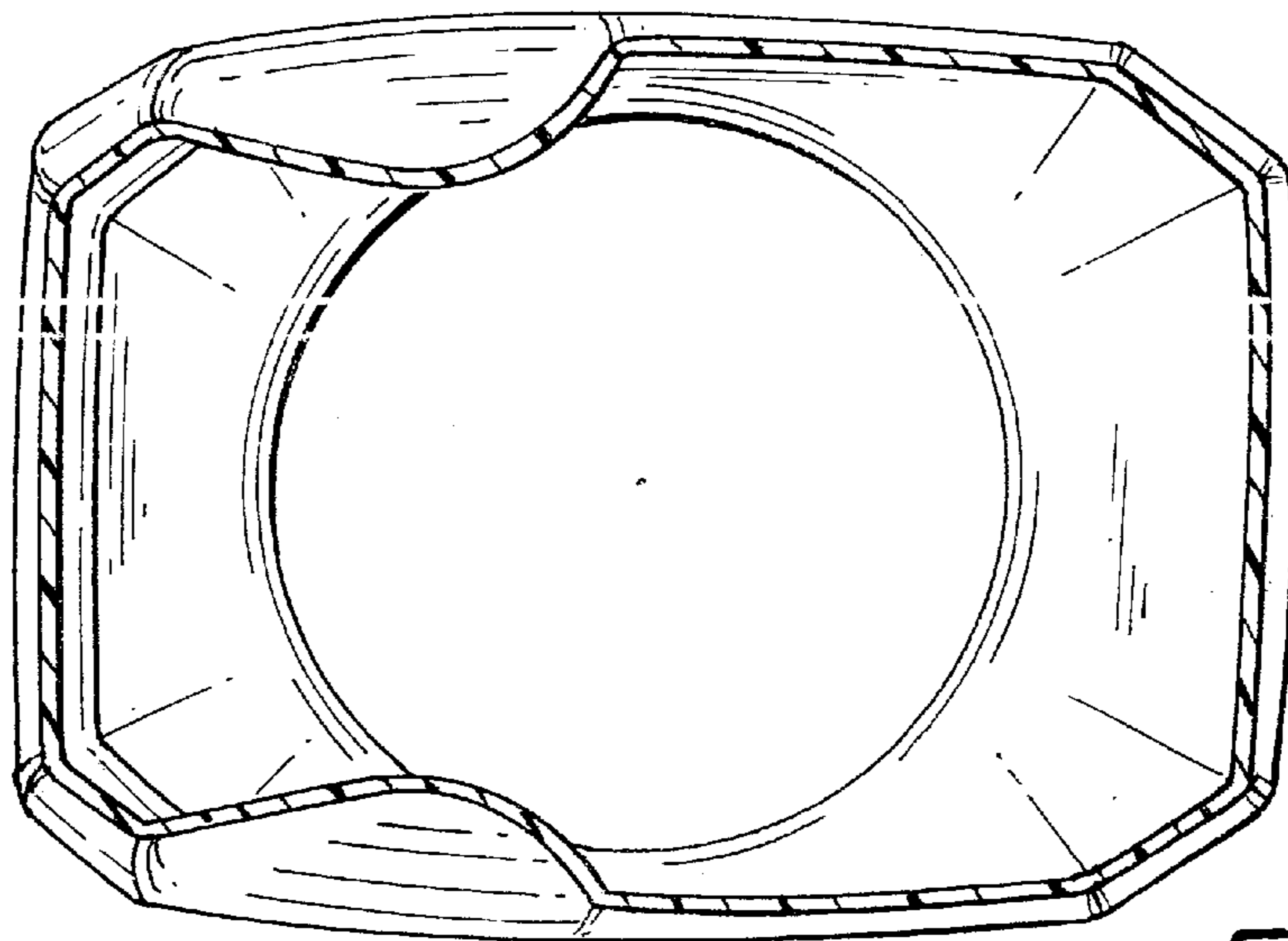

FIG. 6

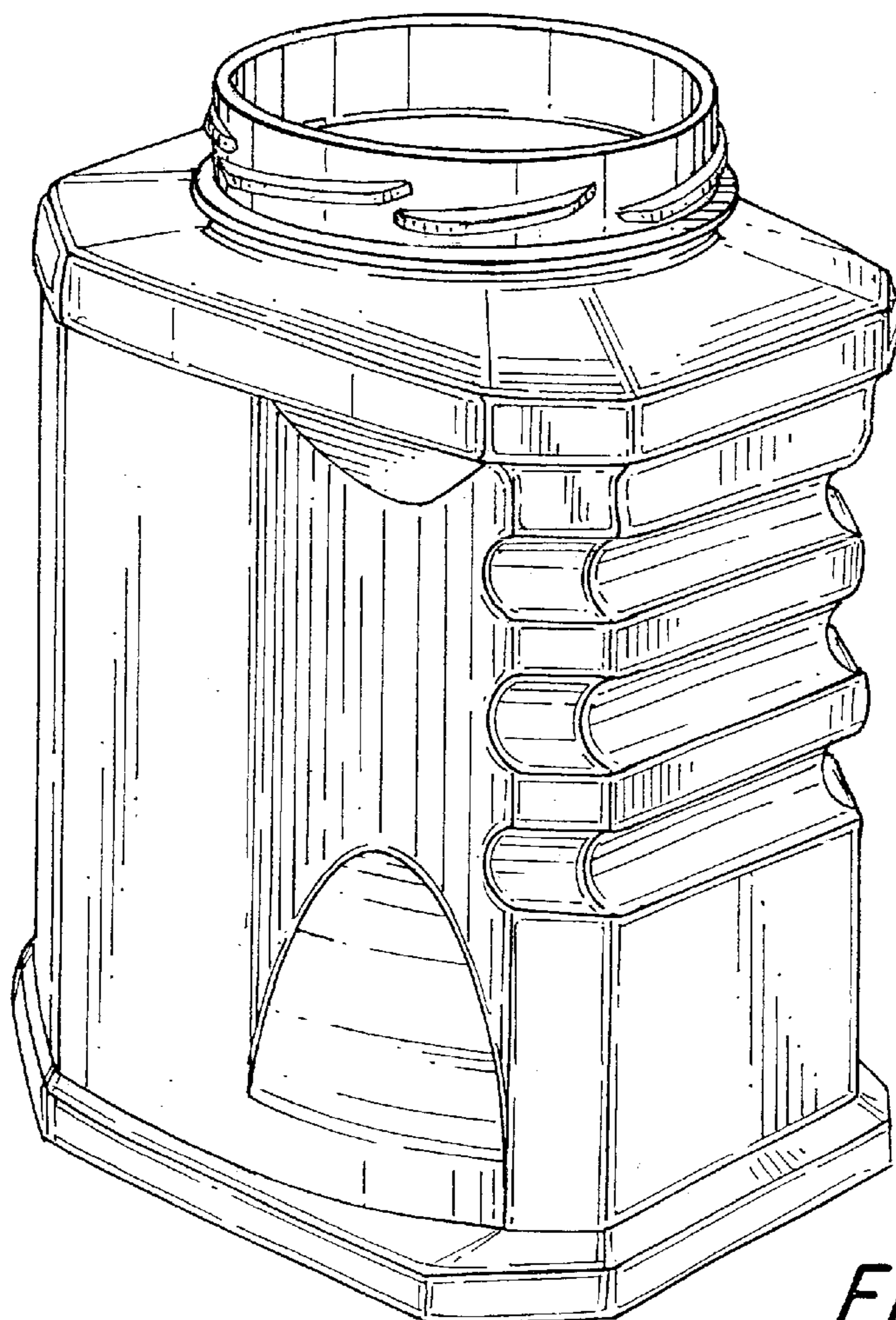

FIG. 7