



US00D527931S

(12) **United States Design Patent**
Kita

(10) **Patent No.:** **US D527,931 S**

(45) **Date of Patent:** **** Sep. 12, 2006**

(54) **CHAIR SEAT**

(75) Inventor: **Toshiyuki Kita**, Osaka (JP)

(73) Assignee: **Takara Belmont Corporation**, Osaka (JP)

(**) Term: **14 Years**

(21) Appl. No.: **29/214,066**

(22) Filed: **Sep. 28, 2004**

(30) **Foreign Application Priority Data**

Mar. 30, 2004 (JP) 2004-009748

(51) **LOC (8) Cl.** **06-06**

(52) **U.S. Cl.** **D6/500; D6/364; D6/379**

(58) **Field of Classification Search** D6/334,
D6/360, 364, 365, 366, 367, 379, 380, 500-502;
297/411.2, 411.28, 411.41, 411.44
See application file for complete search history.

(56) **References Cited**

U.S. PATENT DOCUMENTS

- D289,469 S * 4/1987 Tonon D6/379
- D309,382 S * 7/1990 Buhk D6/360
- D325,305 S * 4/1992 Sottsass et al. D6/379
- D331,154 S * 11/1992 Sheridan D6/366
- D381,828 S * 8/1997 Kemnitzer D6/379

- D423,803 S * 5/2000 Terrell D6/379
- D444,307 S * 7/2001 Minami D6/360
- D487,986 S * 4/2004 Muller D6/365

* cited by examiner

Primary Examiner—Mimosa De

(74) *Attorney, Agent, or Firm*—Armstrong, Kratz, Quintos, Hanson & Brooks, LLP

(57) **CLAIM**

The ornamental design for a chair seat, as shown and described.

DESCRIPTION

FIG. 1 is a perspective view of the chair seat of the present invention;

FIG. 2 is a front view thereof;

FIG. 3 is a rear view thereof;

FIG. 4 is a right side view thereof;

FIG. 5 is a top view thereof;

FIG. 6 is a bottom view thereof;

FIG. 7 is a left side view thereof;

FIG. 8 is a cross-sectional view thereof taken along line II of FIG. 2; and,

FIG. 9 is a right side view of the present invention also showing the article in broken lines in which the design is embodied that is not part of the claimed design.

1 Claim, 5 Drawing Sheets

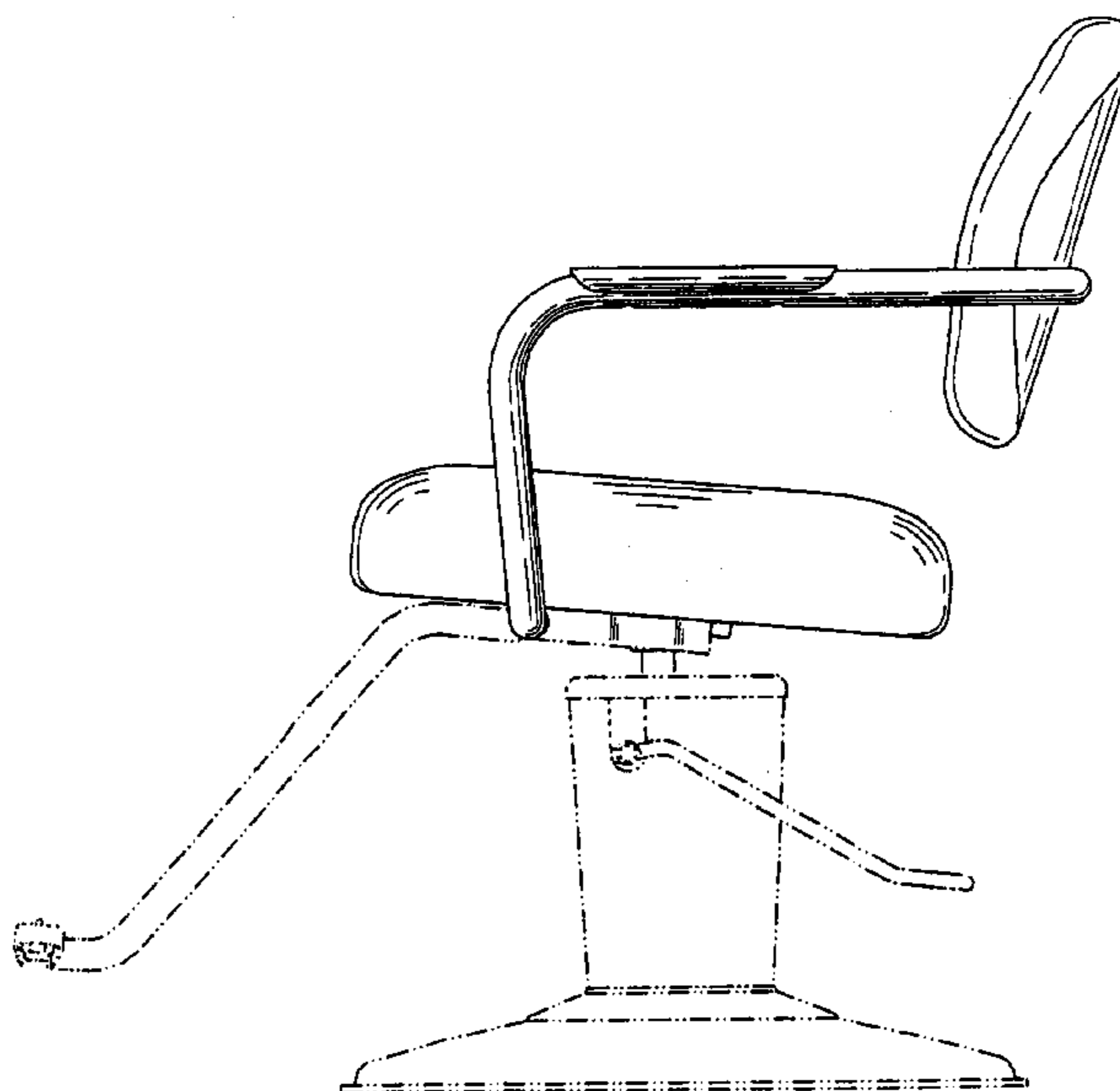
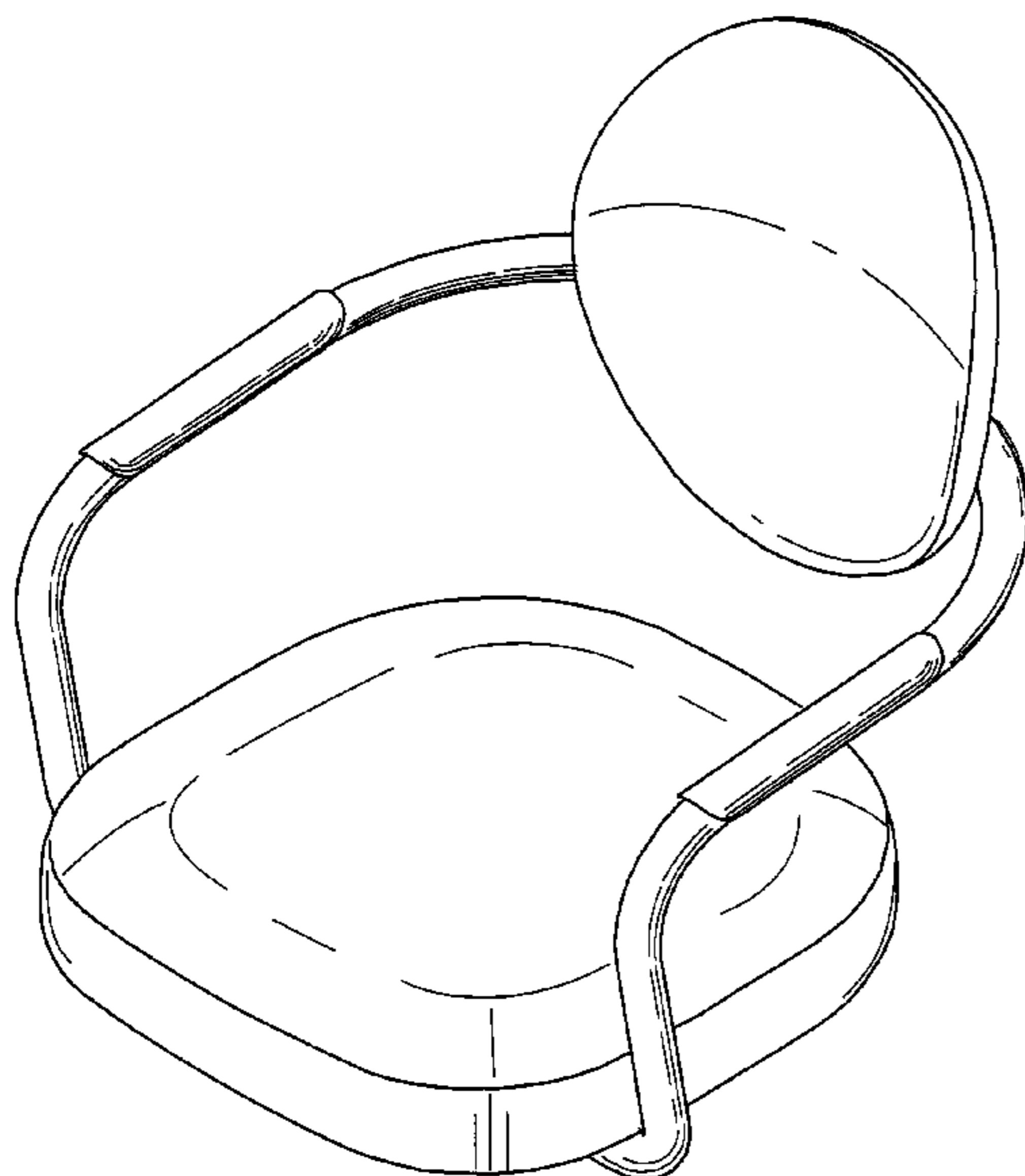

FIG. 1

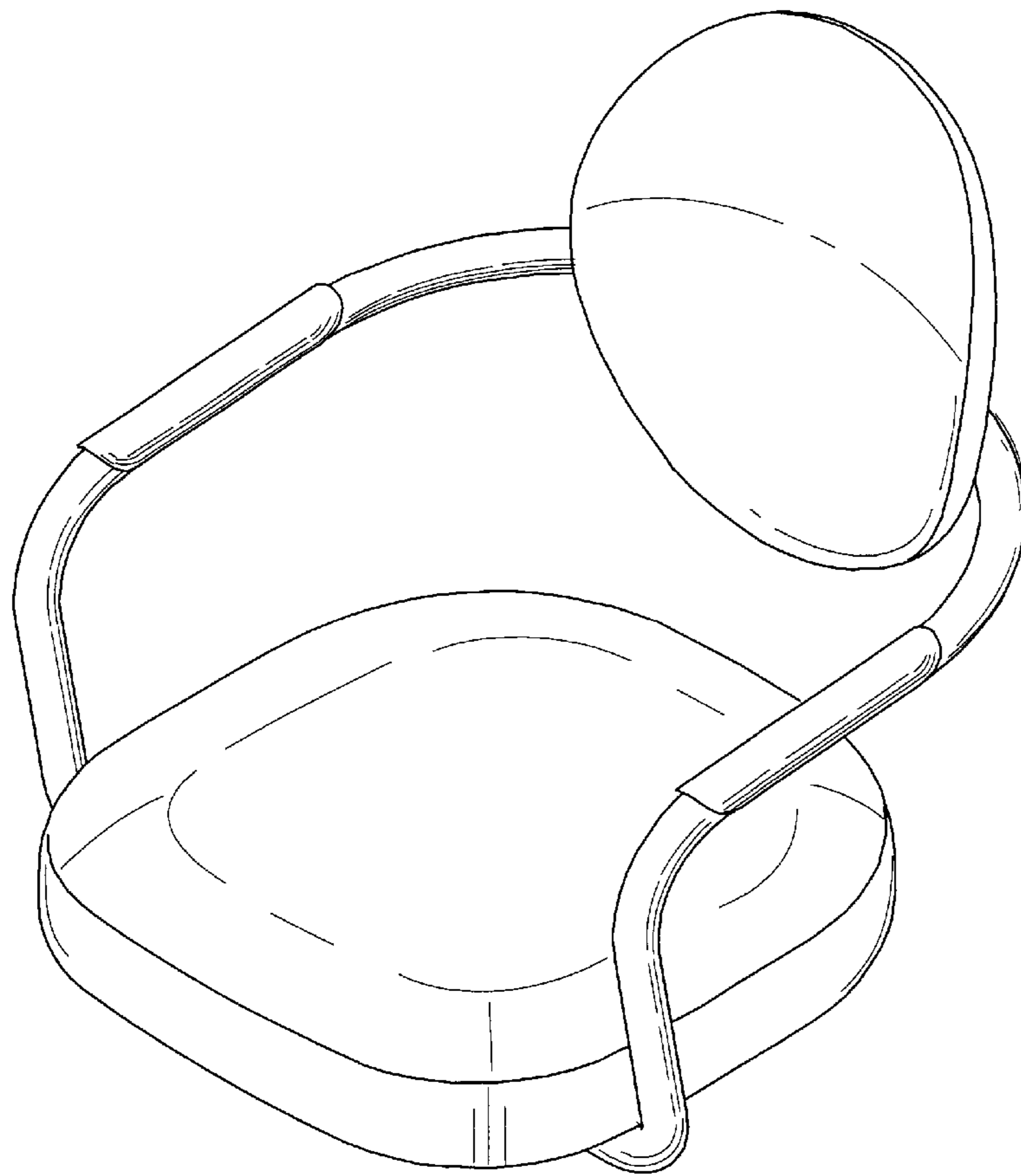

FIG. 2

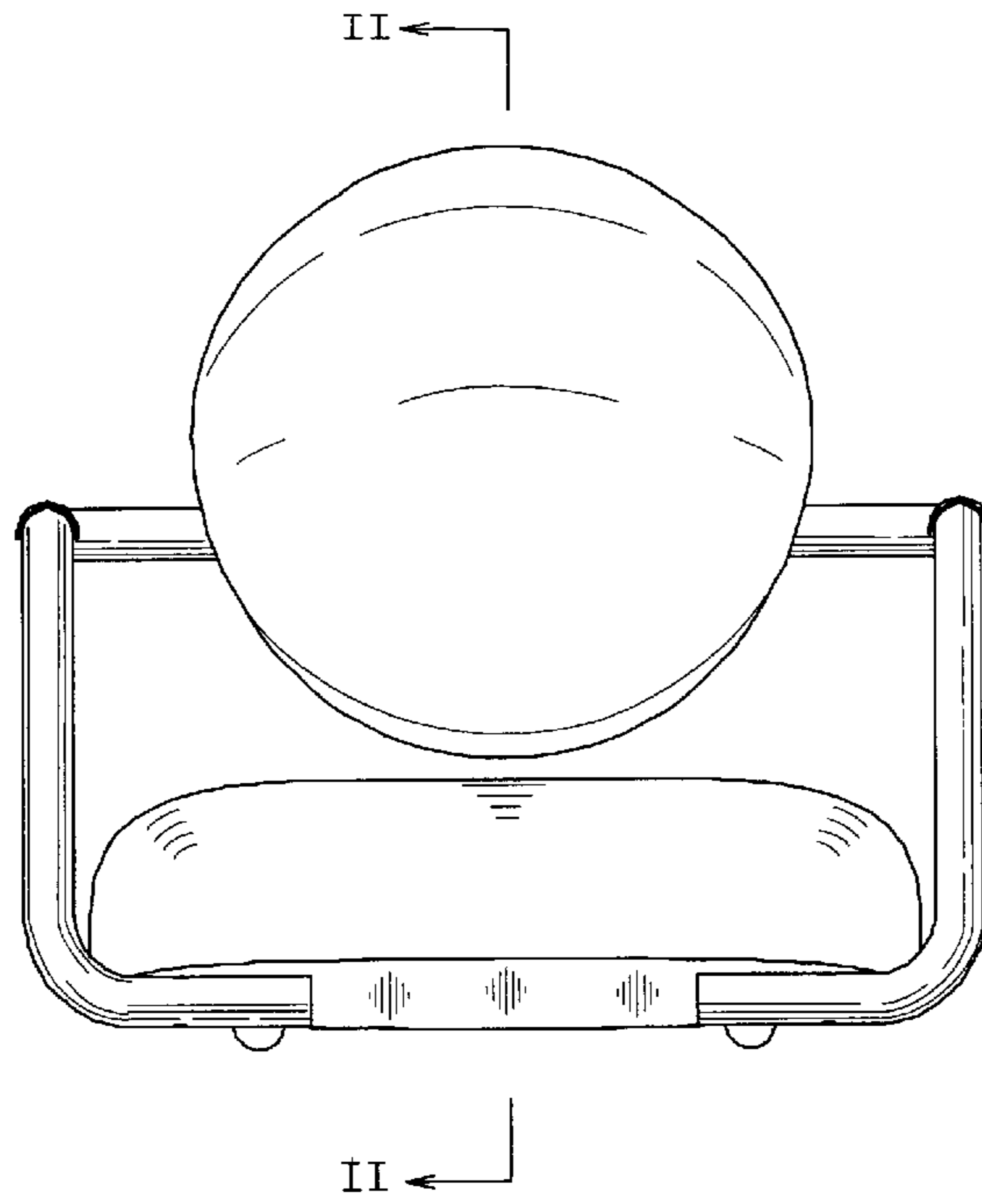

FIG. 3

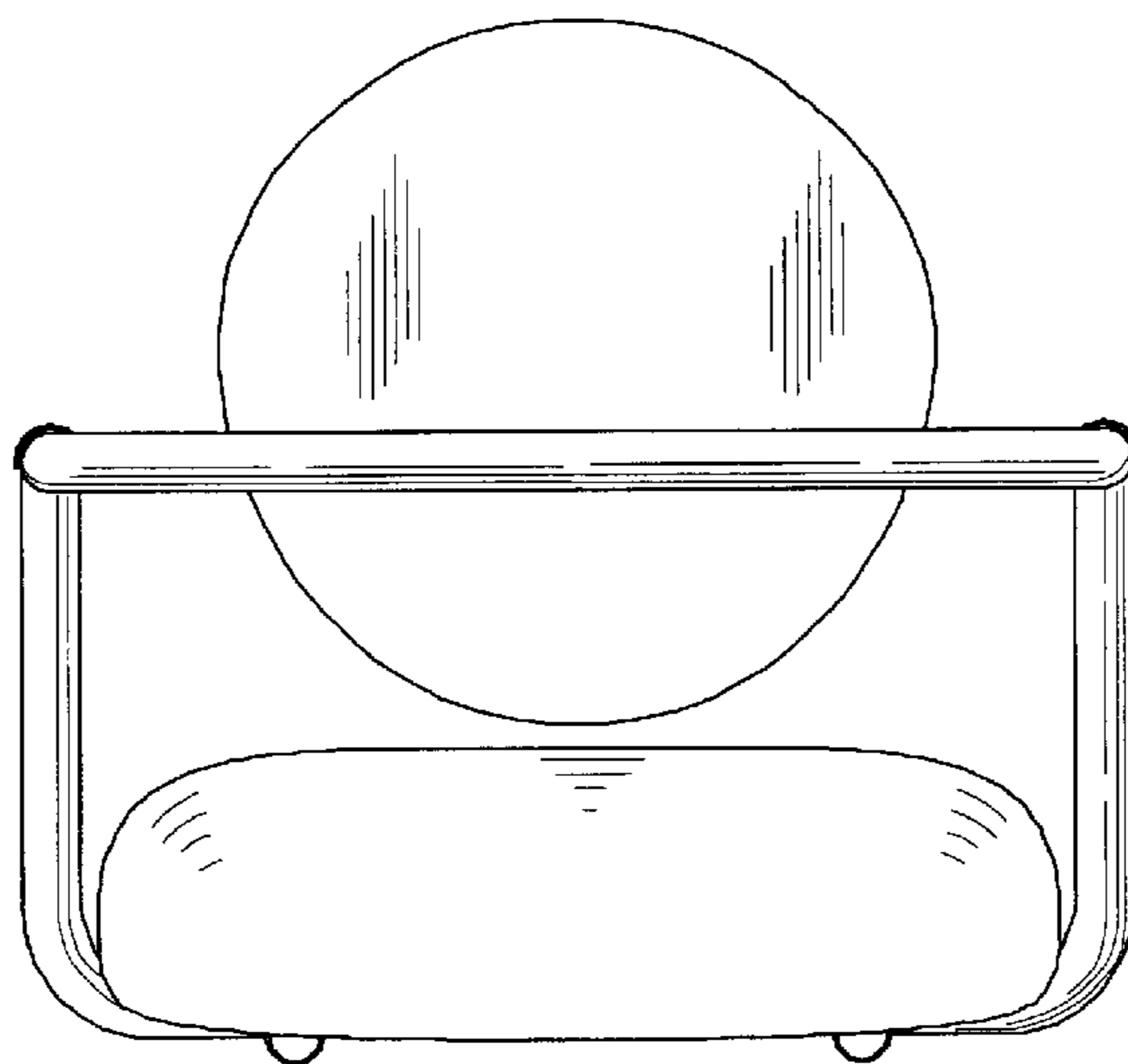

FIG. 4

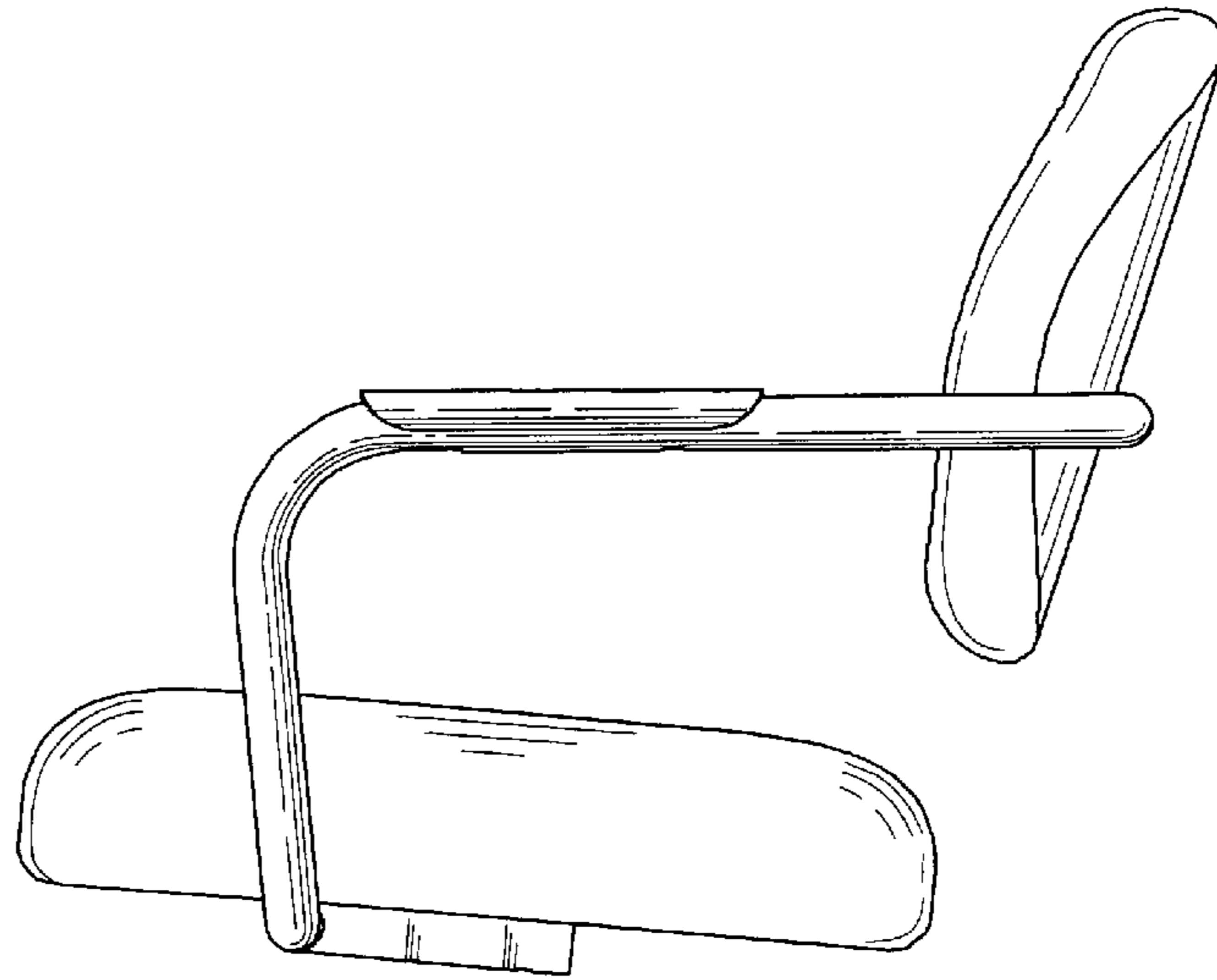

FIG. 5

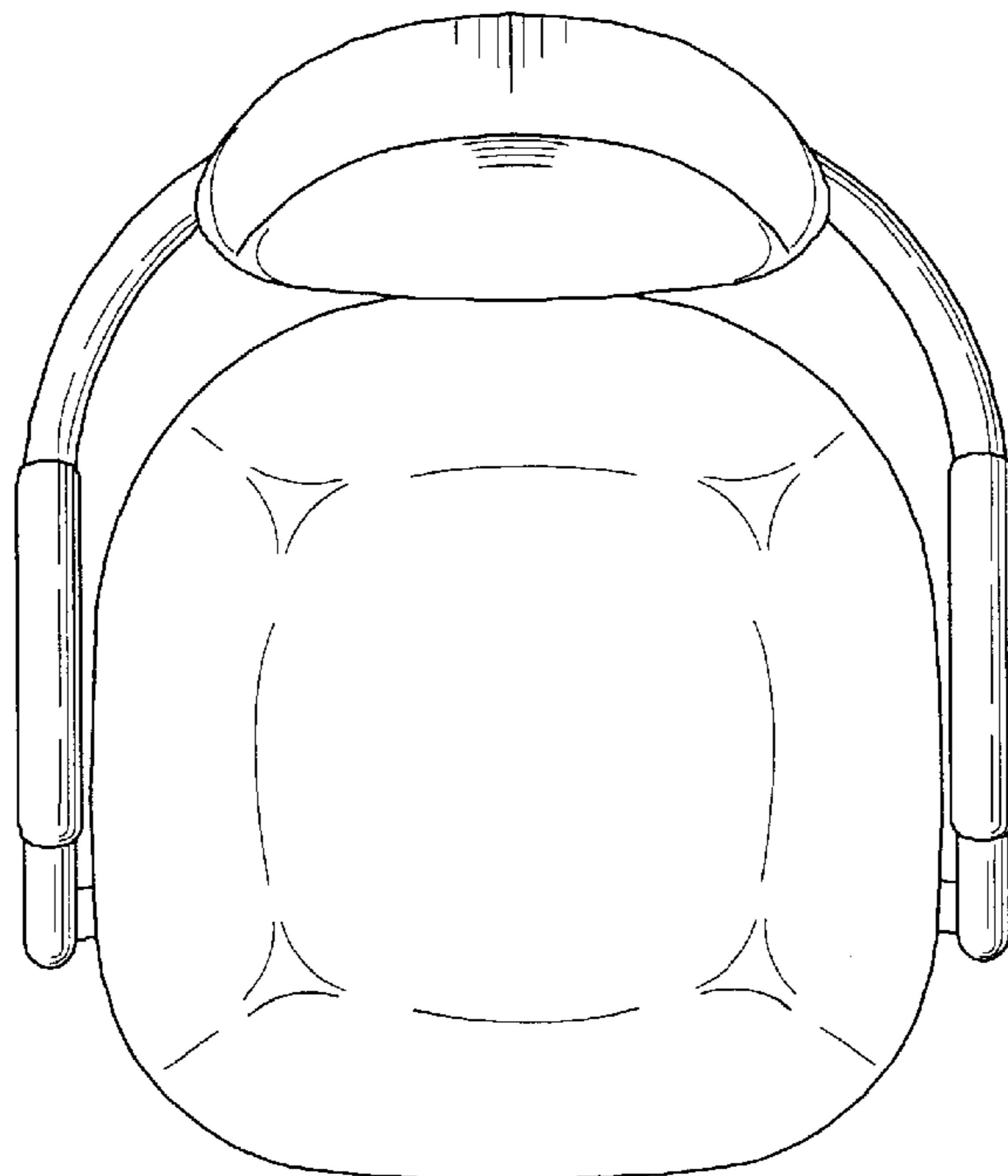

FIG. 6

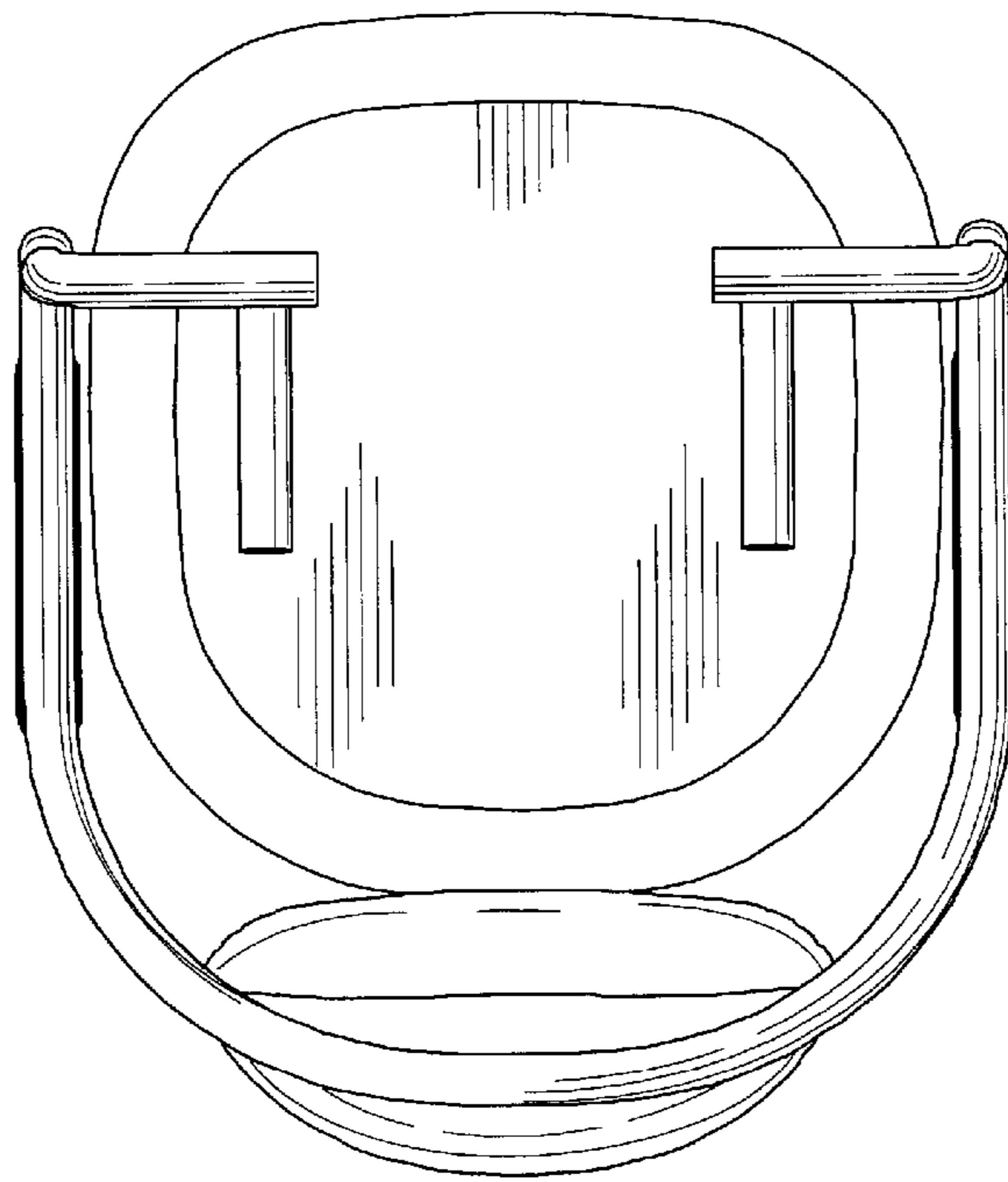

FIG. 7

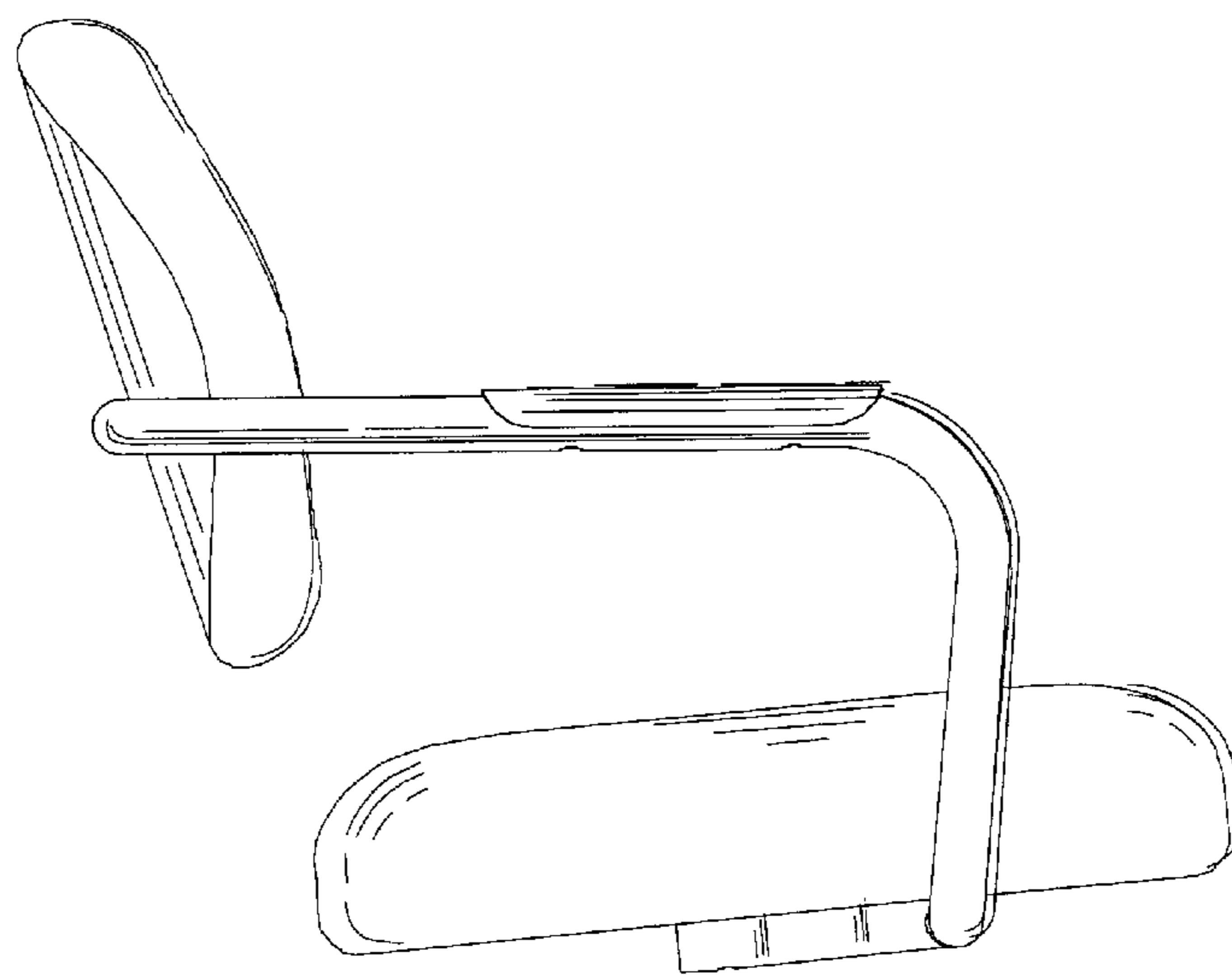

FIG. 8

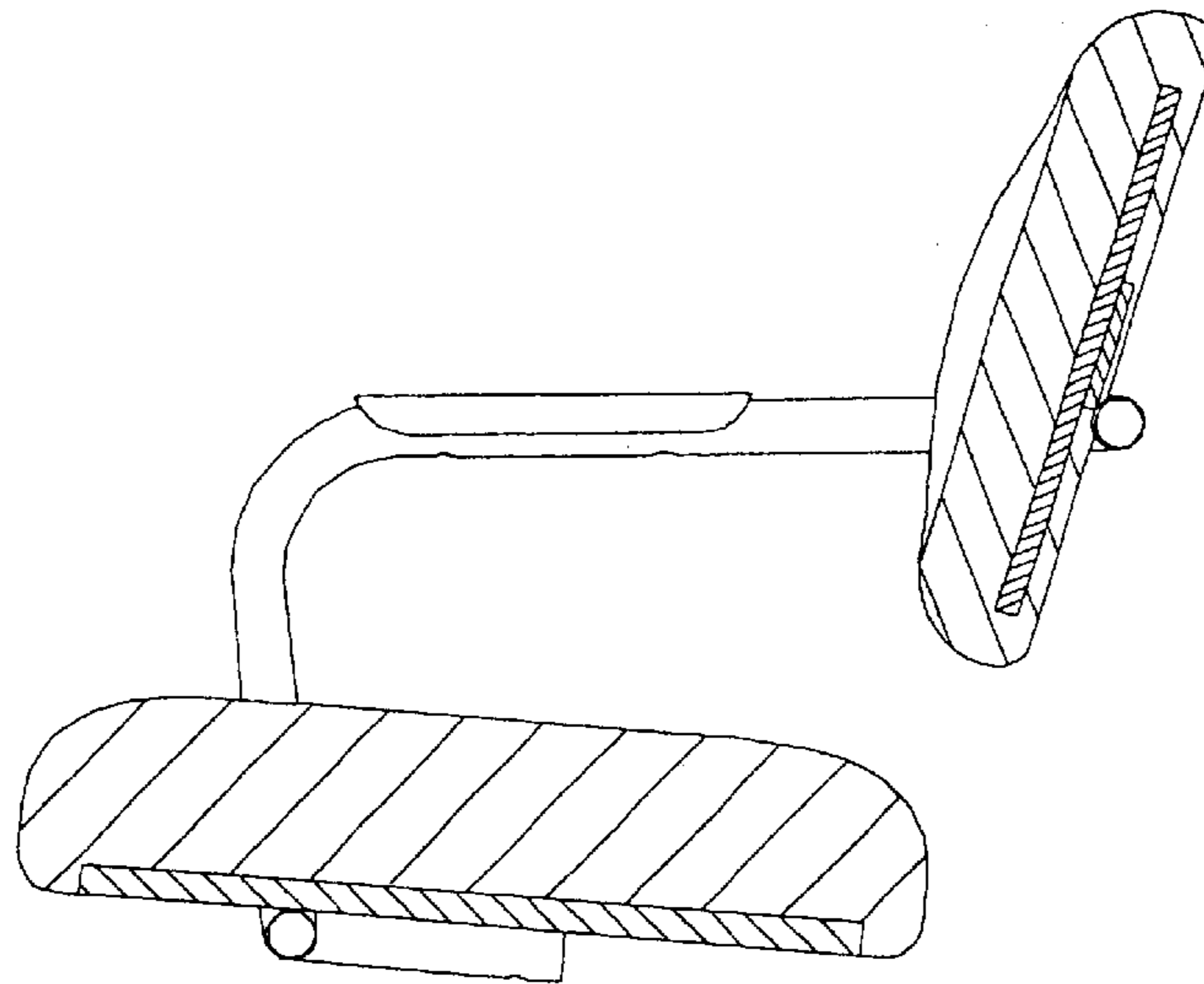

FIG. 9

