

US00D527834S

(12) **United States Design Patent**
Thimons et al.

(10) **Patent No.:** **US D527,834 S**
(45) **Date of Patent:** **** Sep. 5, 2006**

(54) **BUILDING PANEL**

(75) Inventors: **Mark A. Thimons**, Natrona Heights, PA (US); **Mark J. Klos**, West Mifflin, PA (US)

(73) Assignee: **Centria**, Moon Township, PA (US)

(**) Term: **14 Years**

(21) Appl. No.: **29/203,806**

(22) Filed: **Apr. 20, 2004**

(51) **LOC (8) Cl.** **25-01**

(52) **U.S. Cl.** **D25/119**

(58) **Field of Classification Search** D25/119,
D25/138; 52/519, 520, 537, 478, 311.2, 588.1
See application file for complete search history.

(56) **References Cited**

U.S. PATENT DOCUMENTS

D259,143 S * 5/1981 Aktinson D25/119
5,524,409 A * 6/1996 Kaiser 52/588.1
5,775,042 A * 7/1998 Mowery et al. 52/520
D449,120 S * 10/2001 Kulik D25/138

OTHER PUBLICATIONS

“Commercial & Industrial Metal Wall Systems” Robertson Product Brochure, p. 9 (1994).

* cited by examiner

Primary Examiner—Doris Clark

(74) *Attorney, Agent, or Firm*—Buchanan Ingersoll PC

(57) **CLAIM**

The ornamental design for a building panel, as shown and described.

DESCRIPTION

FIG. 1 is a perspective view of a building panel showing our new design;

FIG. 2 is a left side elevational view thereof;

FIG. 3 is a front elevational view thereof;

FIG. 4 is a bottom plan view thereof;

FIG. 5 is a top plan view thereof;

FIG. 6 is a perspective view of two building panels attached together;

FIG. 7 is a perspective view of a second embodiment of our new design;

FIG. 8 is a left side elevational view thereof;

FIG. 9 is a front elevational view thereof;

FIG. 10 is a bottom plan view thereof;

FIG. 11 is a top plan view thereof;

FIG. 12 is a perspective view of two building panels attached together;

FIG. 13 is a perspective view of a third embodiment of our new design;

FIG. 14 is a left side elevational view thereof;

FIG. 15 is a front elevational view thereof;

FIG. 16 is a bottom plan view thereof;

FIG. 17 is a top plan view thereof;

FIG. 18 is a perspective view of two building panels attached together;

FIG. 19 is a perspective view of a fourth embodiment of our new design;

FIG. 20 is a left side elevational view thereof;

FIG. 21 is a front elevational view thereof;

FIG. 22 is a bottom plan view thereof;

FIG. 23 is a top plan view thereof;

FIG. 24 is a perspective view of two building panels attached together;

FIG. 25 is a perspective view of a fifth embodiment of our new design;

FIG. 26 is a left side elevational view thereof;

FIG. 27 is a front elevational view thereof;

FIG. 28 is a bottom plan view thereof;

FIG. 29 is a top plan view thereof;

FIG. 30 is a perspective view of two building panels attached together;

FIG. 31 is a perspective view of a sixth embodiment of our new design;

FIG. 32 is a left side elevational view thereof;

FIG. 33 is a front elevational view thereof;

FIG. 34 is a bottom plan view thereof;

FIG. 35 is a top plan view thereof;

FIG. 36 is a perspective view of two building panels attached together;

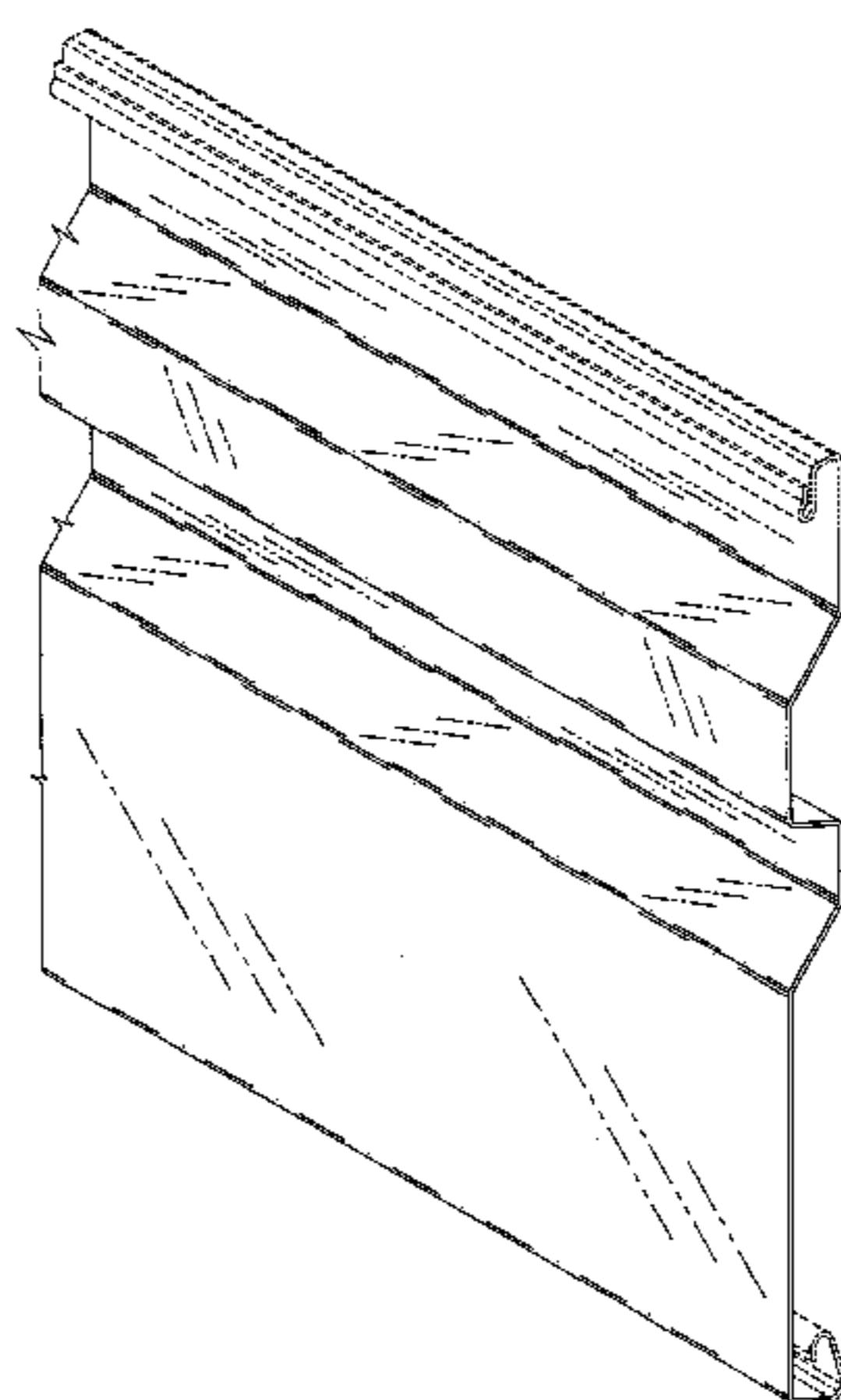

FIG. **37** is a perspective view of a seventh embodiment of our new design;
FIG. **38** is a left side elevational view thereof;
FIG. **39** is a front elevational view thereof;
FIG. **40** is a bottom plan view thereof;
FIG. **41** is a top plan view thereof;
FIG. **42** is a perspective view of two building panels attached together.

The broken lines are for illustrative purposes only and form no part of the claimed design. The claimed design is broken on one side to indicate indefinite length.

1 Claim, 28 Drawing Sheets

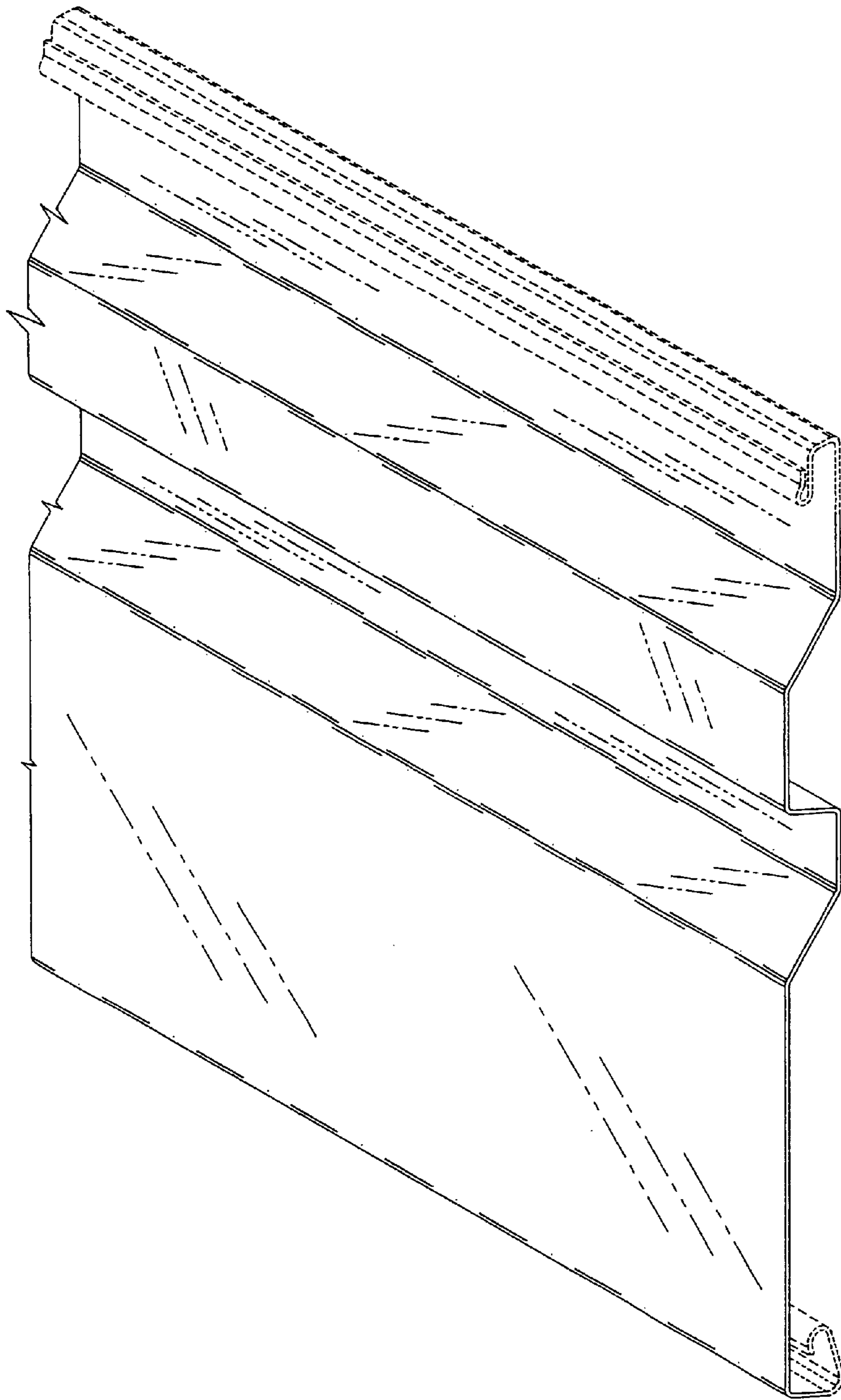

FIG. 1

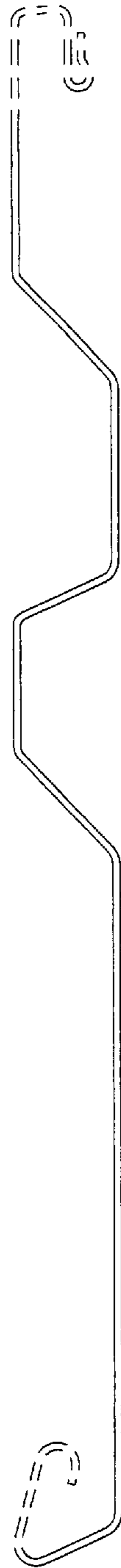

FIG. 2

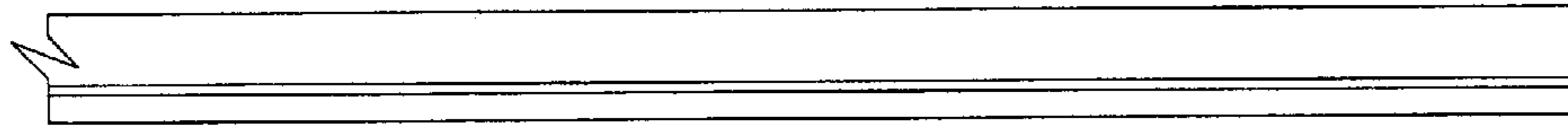

FIG. 5

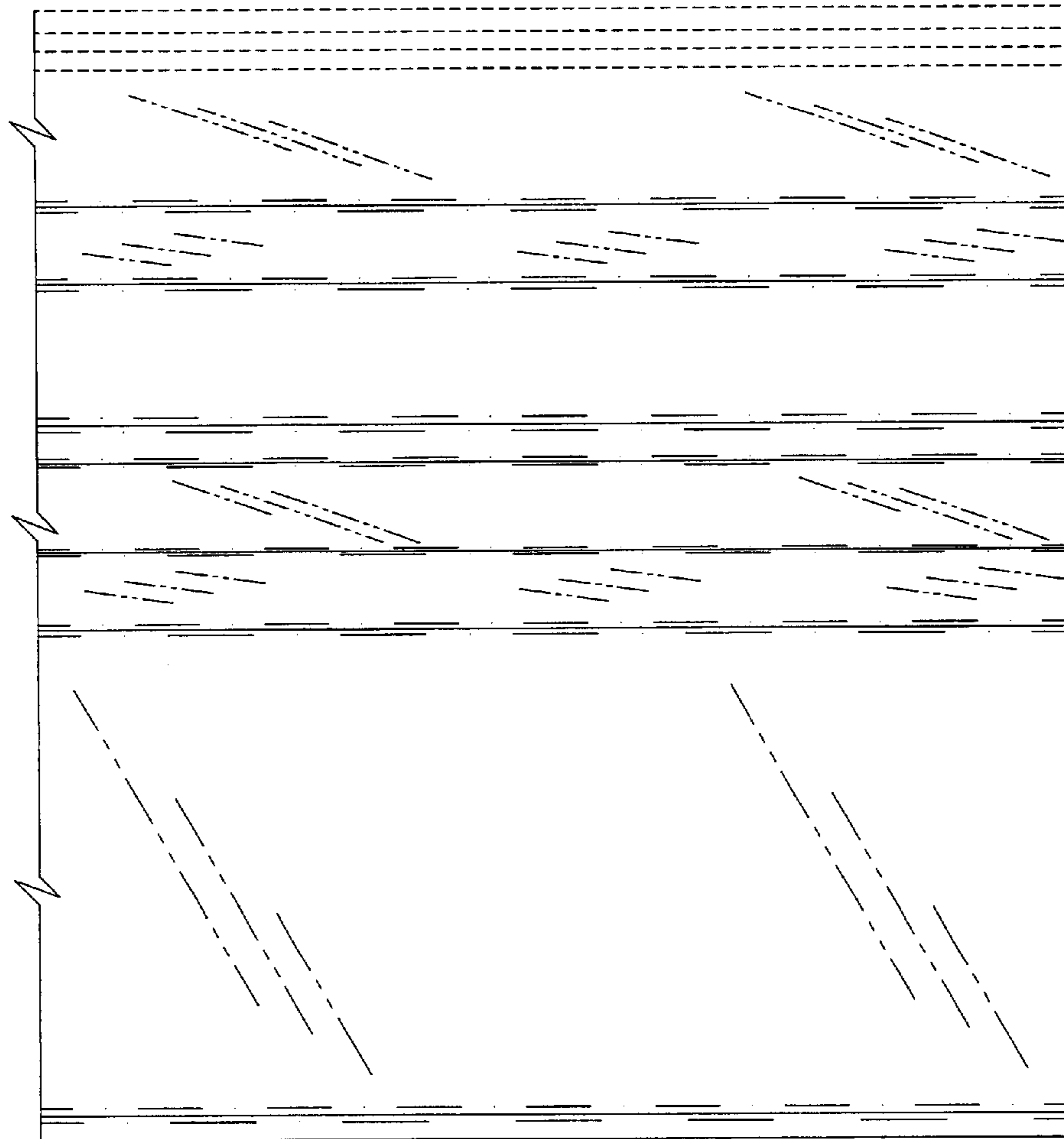

FIG. 3



FIG. 4

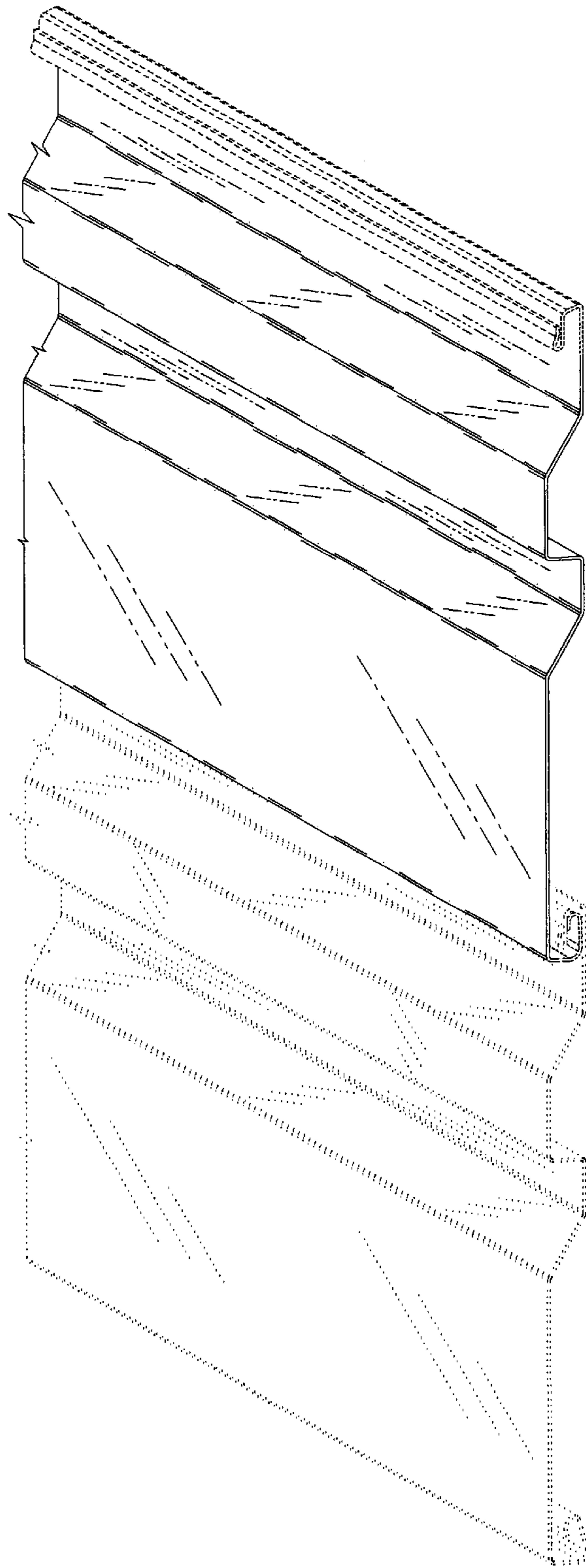

FIG. 6

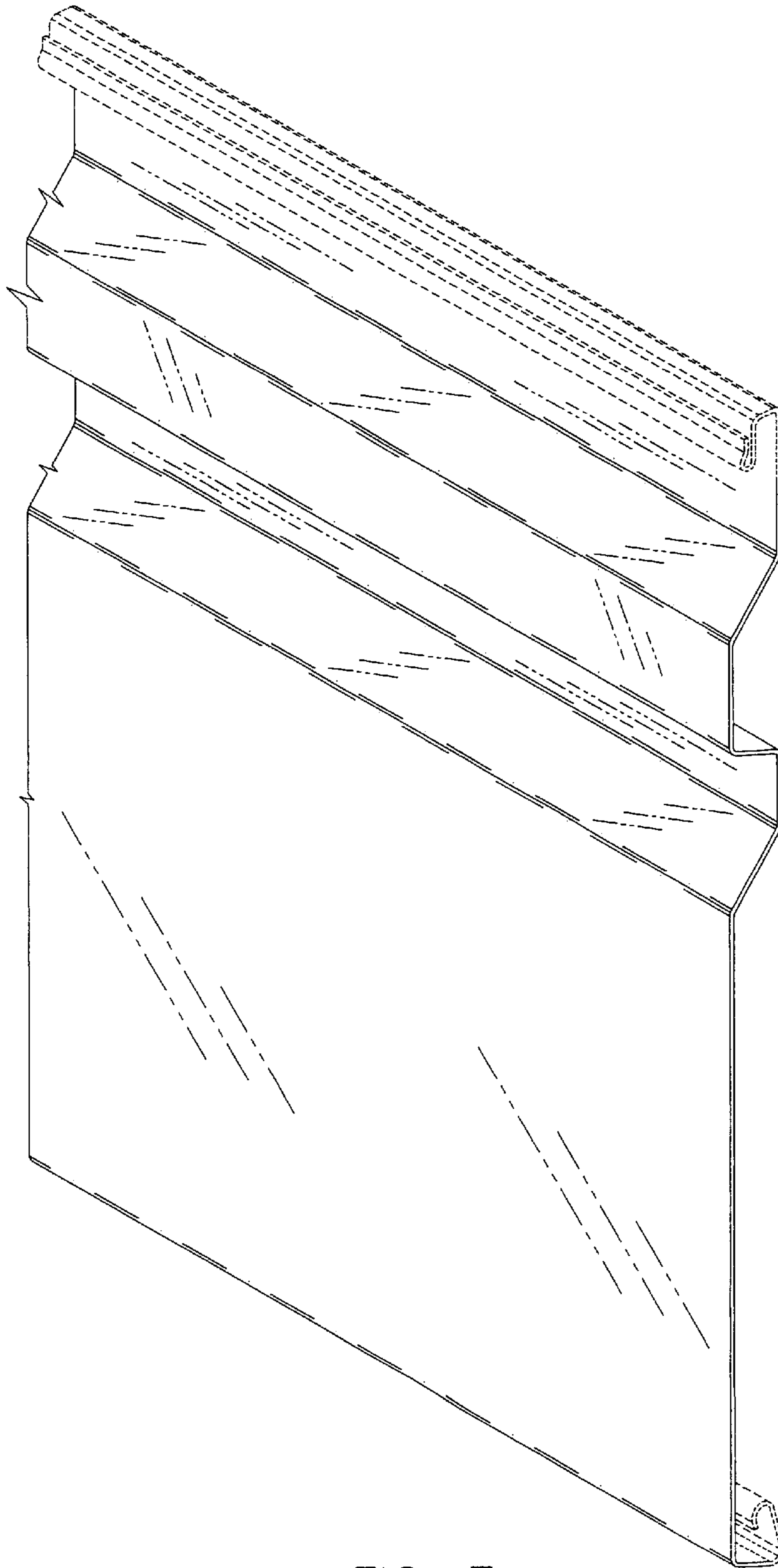

FIG. 7



FIG. 8

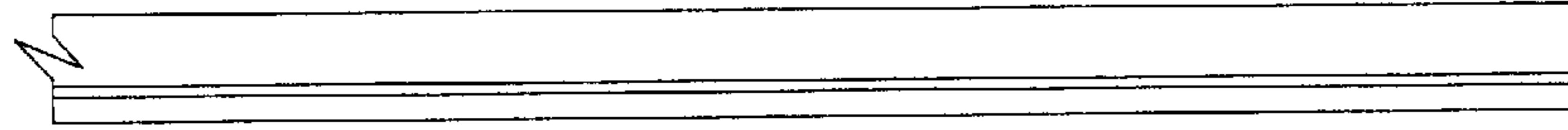

FIG. 11

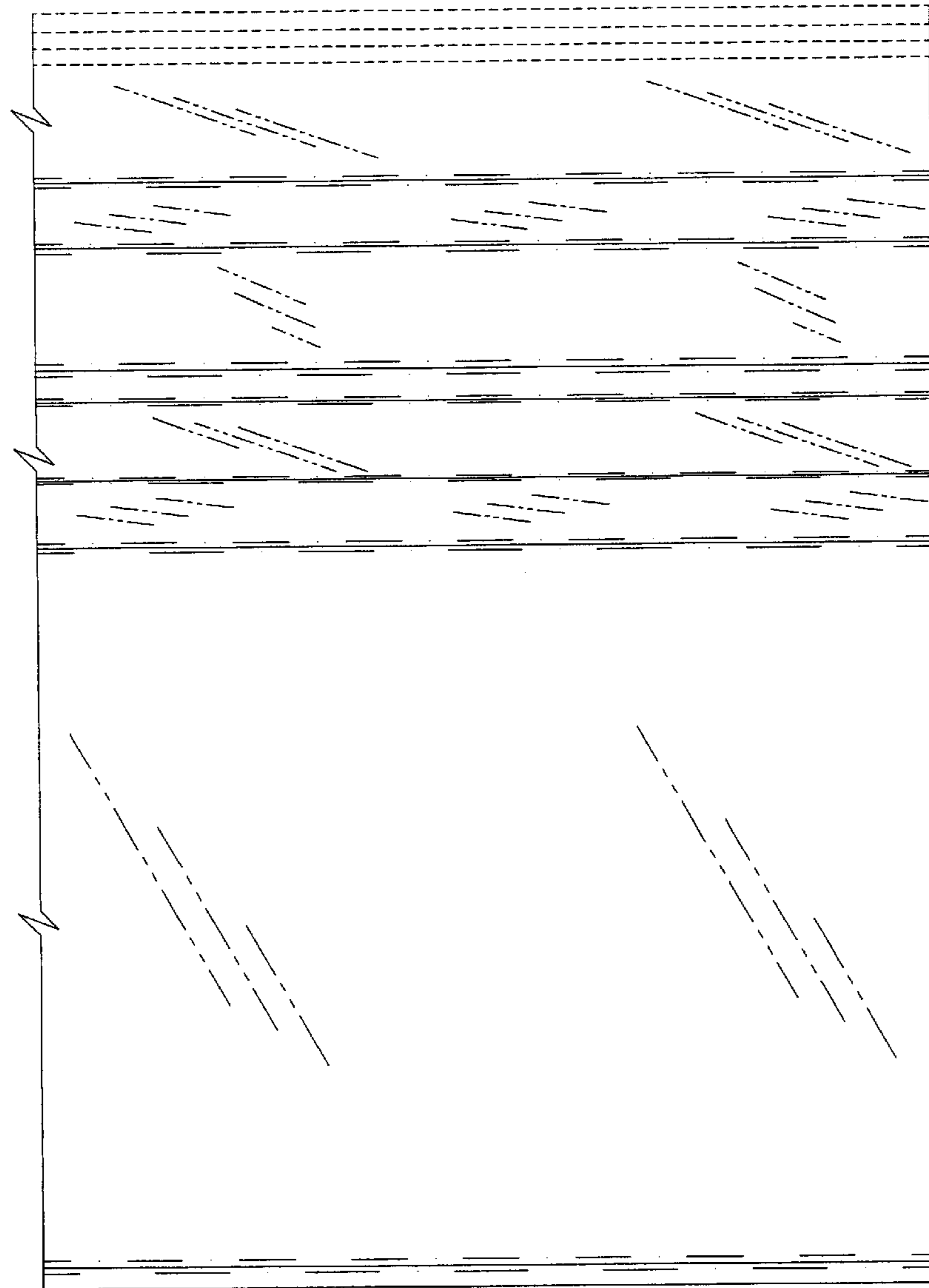

FIG. 9

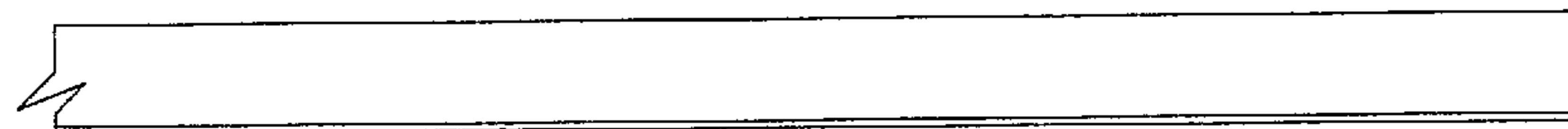

FIG. 10

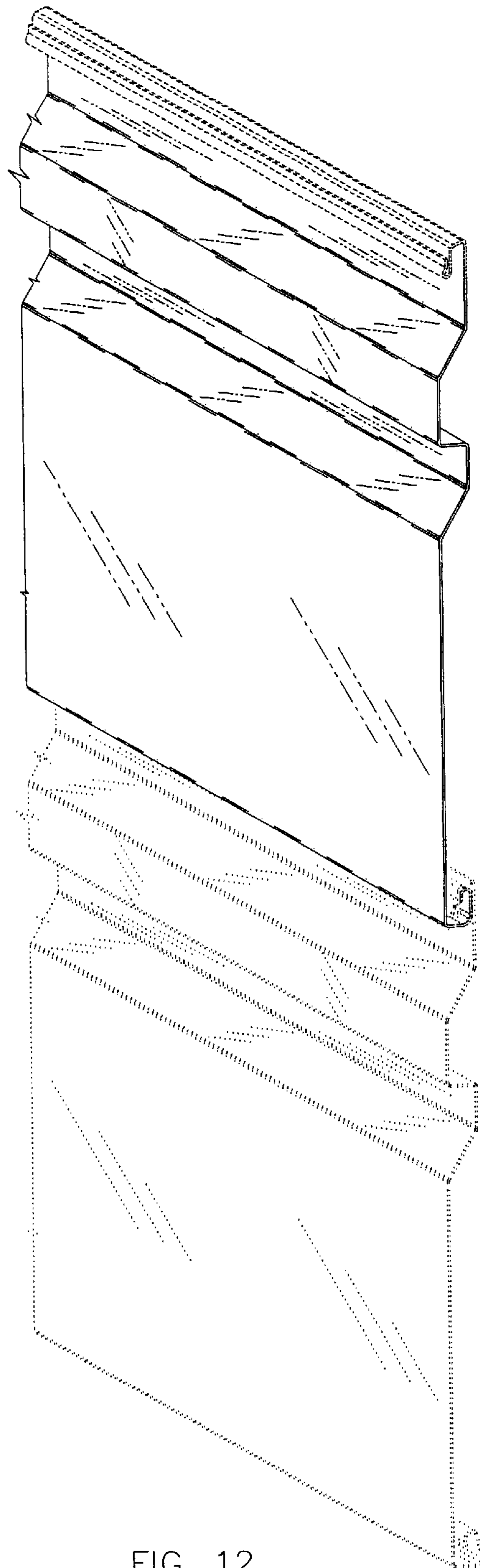

FIG. 12

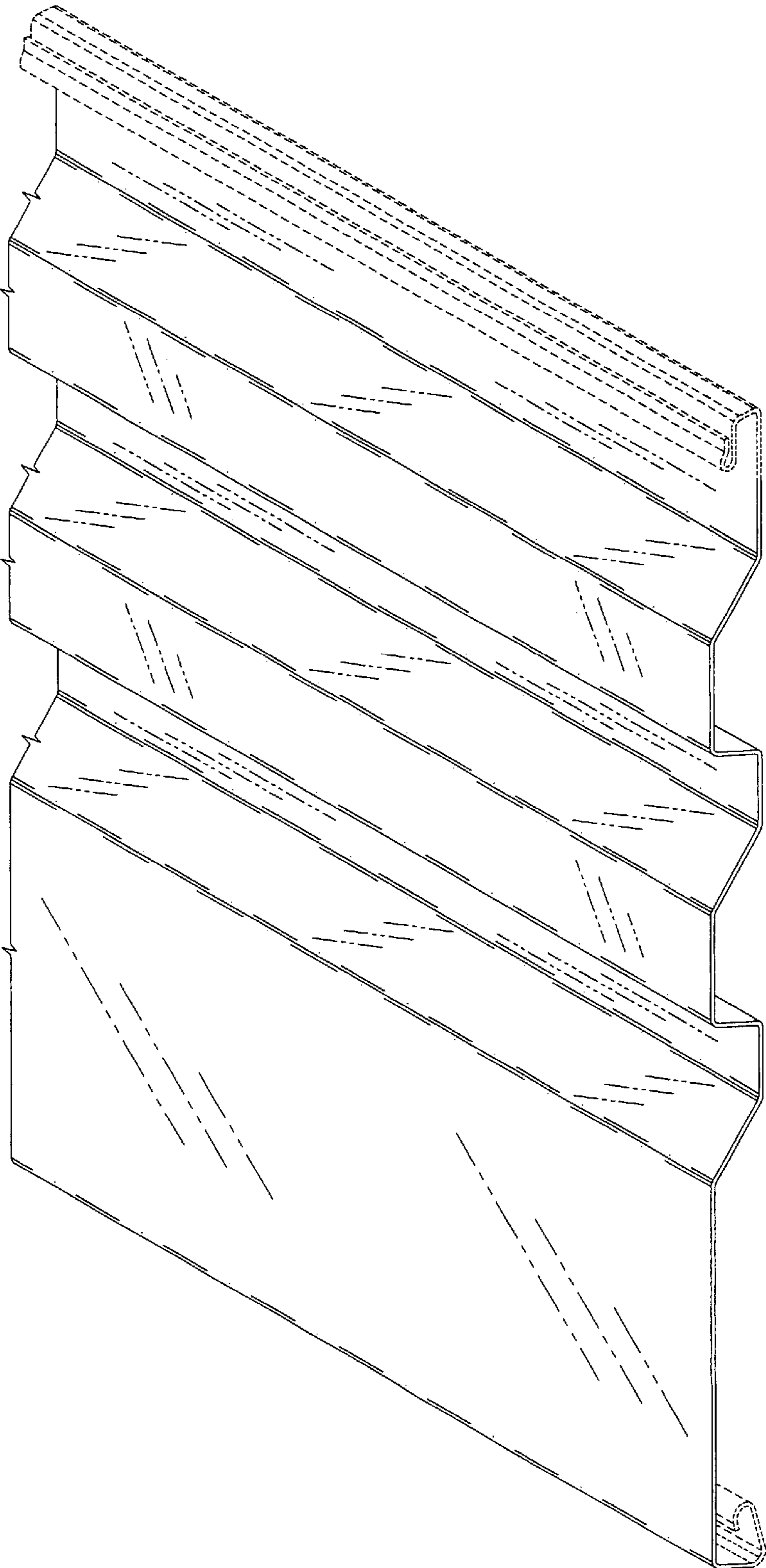

FIG. 13

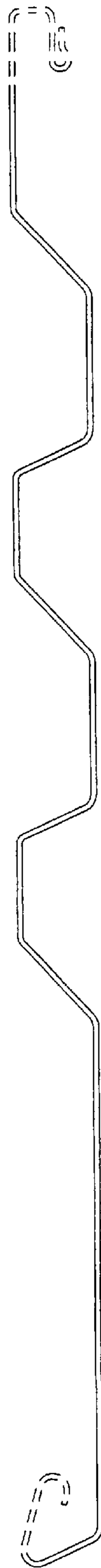

FIG. 14

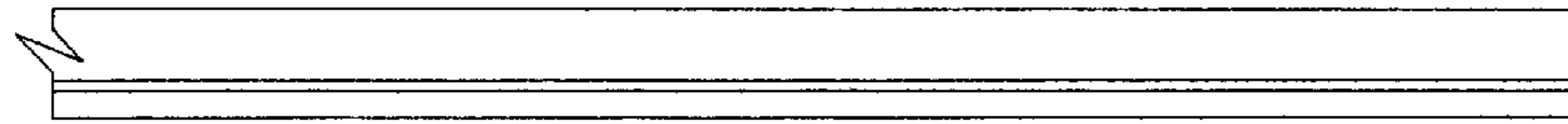

FIG. 17

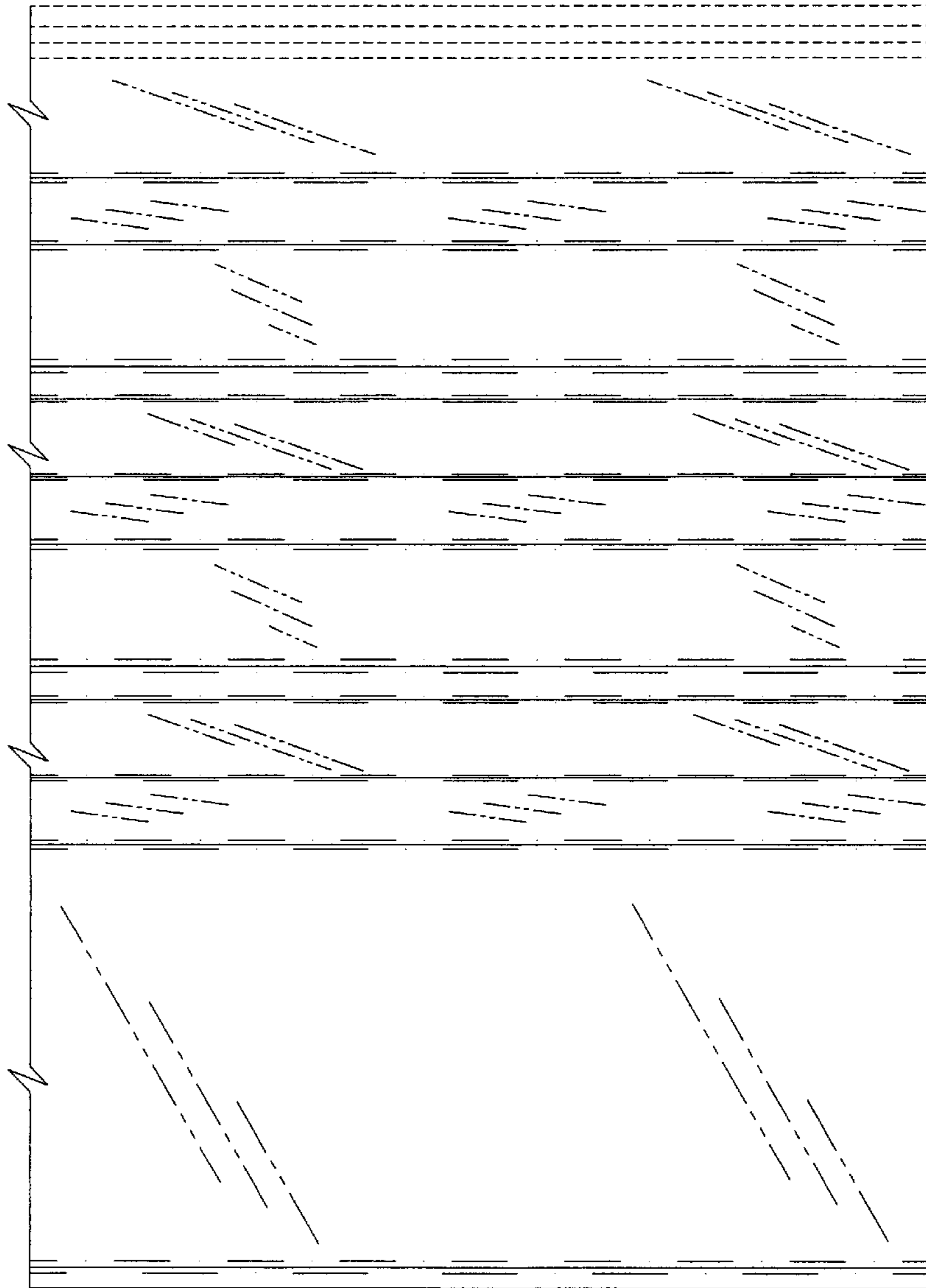

FIG. 15

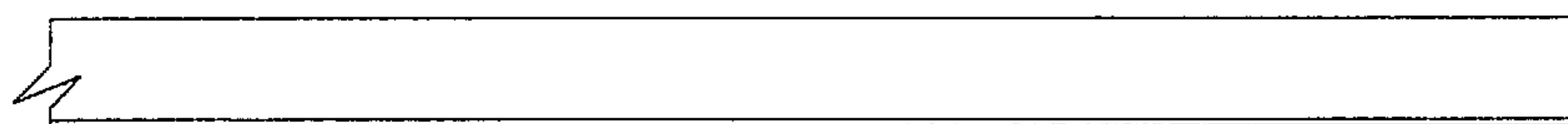

FIG. 16

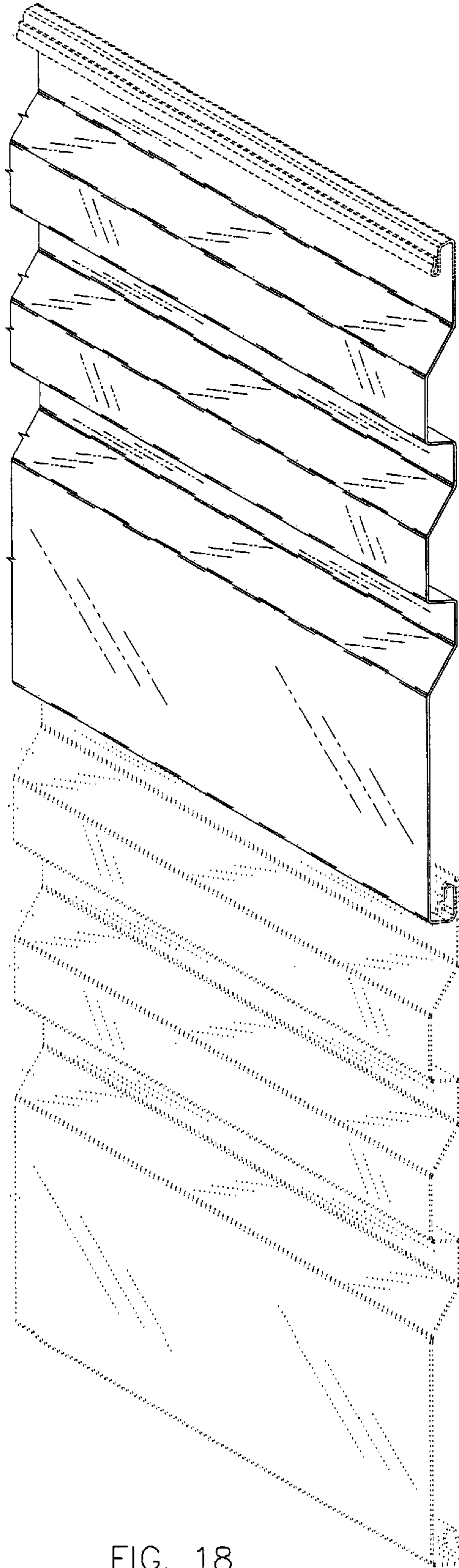

FIG. 18

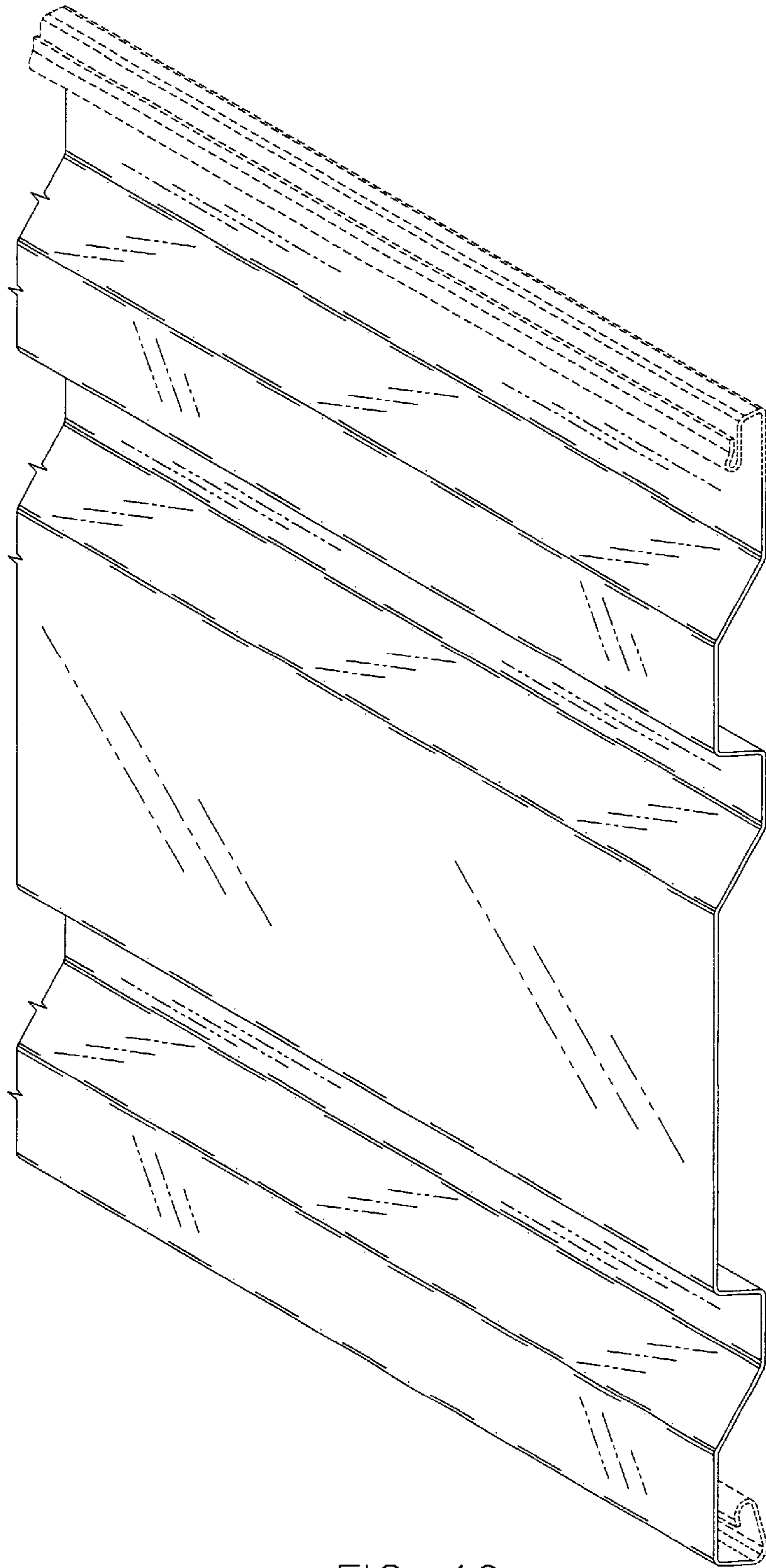

FIG. 19

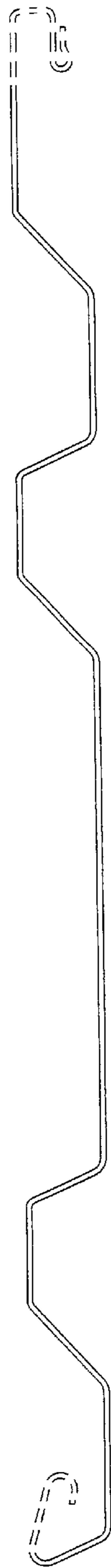

FIG. 20

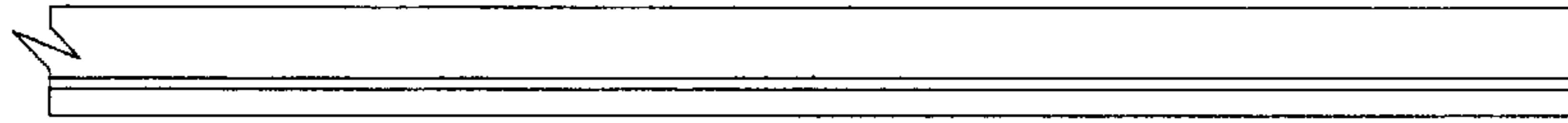

FIG. 23

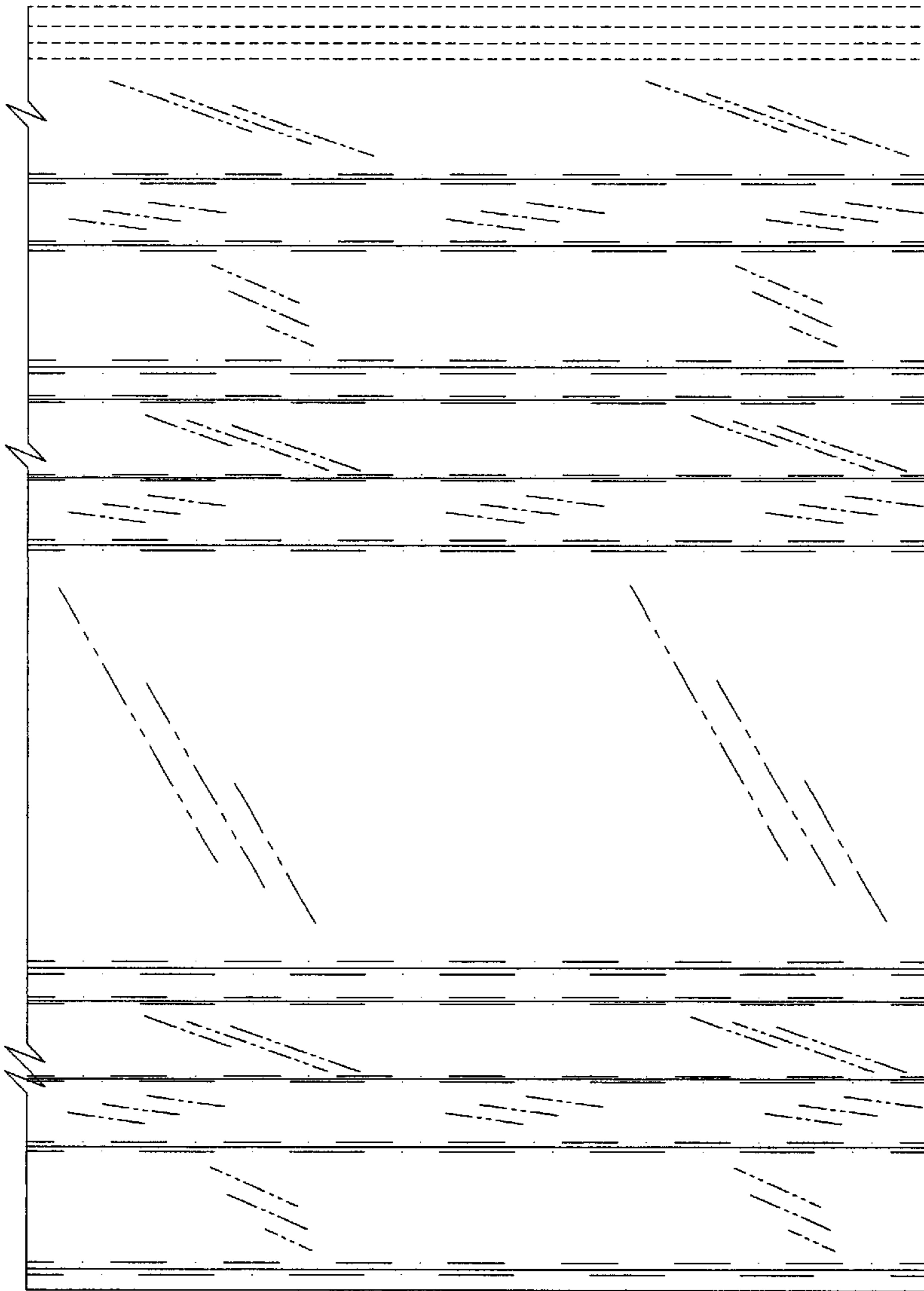

FIG. 21



FIG. 22

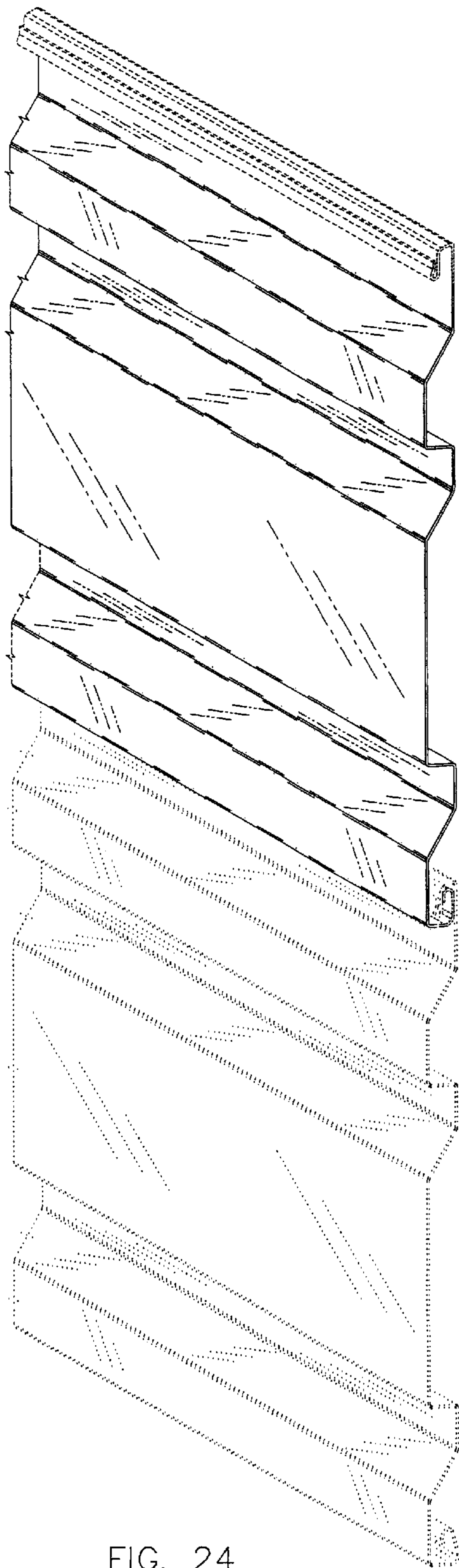

FIG. 24

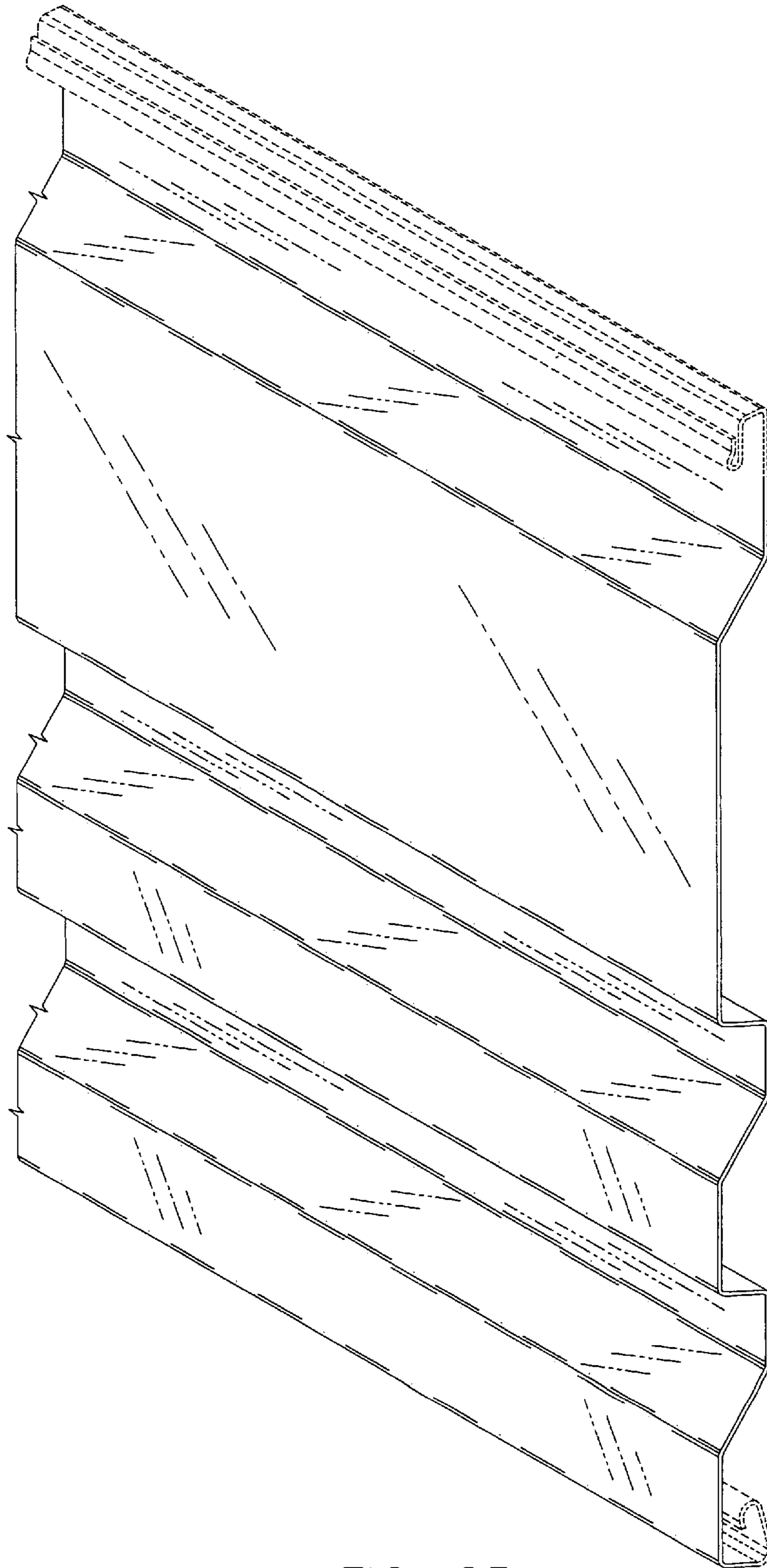

FIG. 25

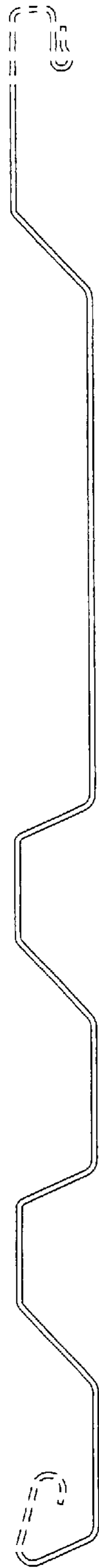

FIG. 26

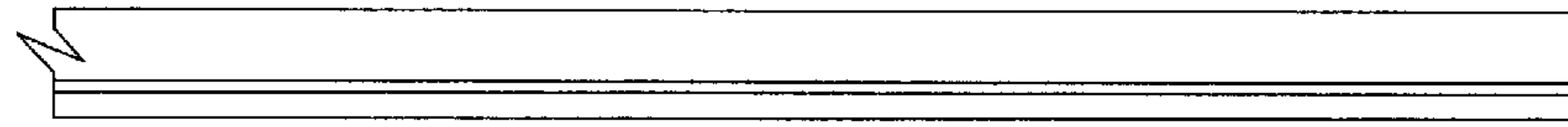

FIG. 29

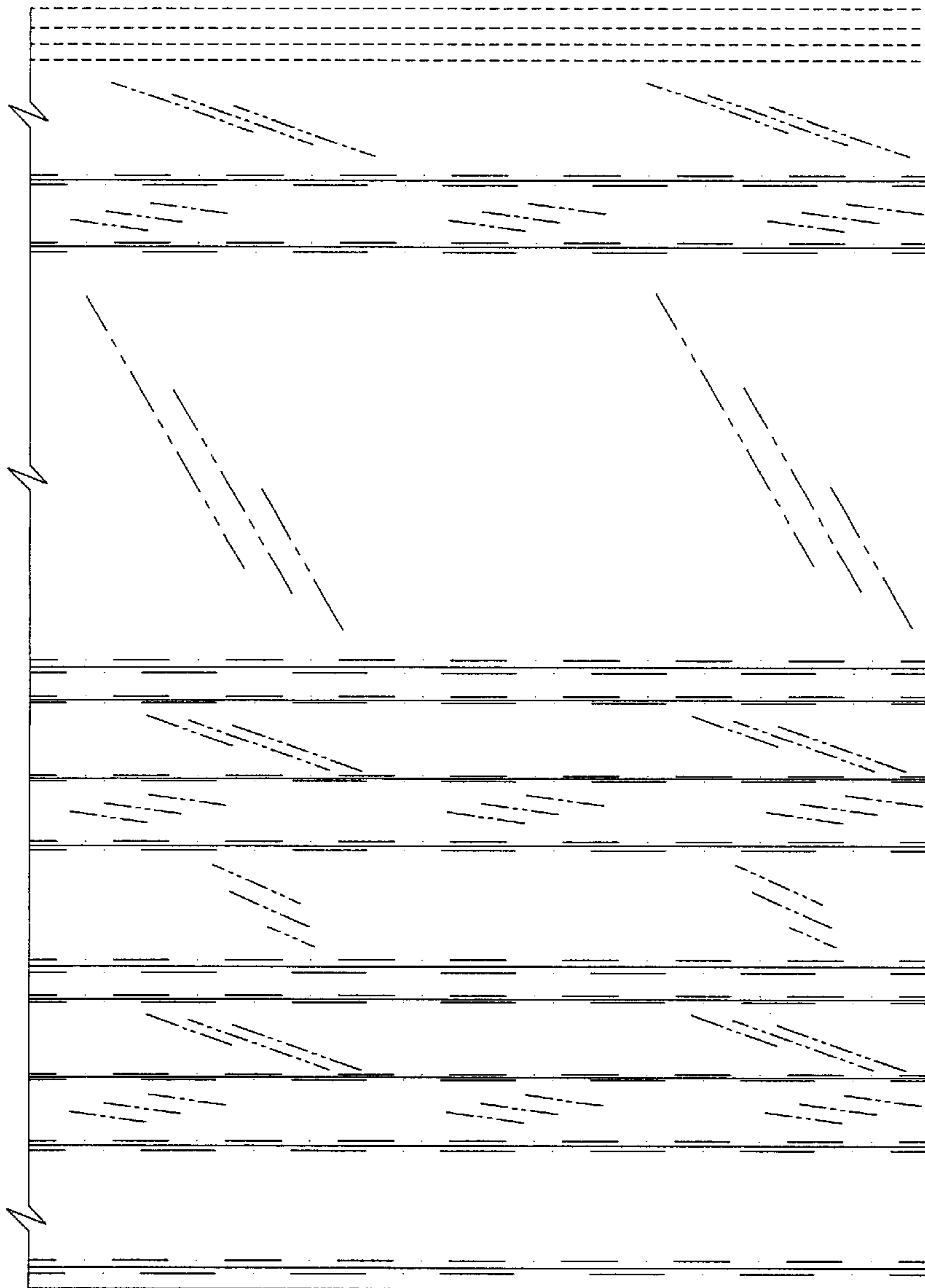

FIG. 27



FIG. 28

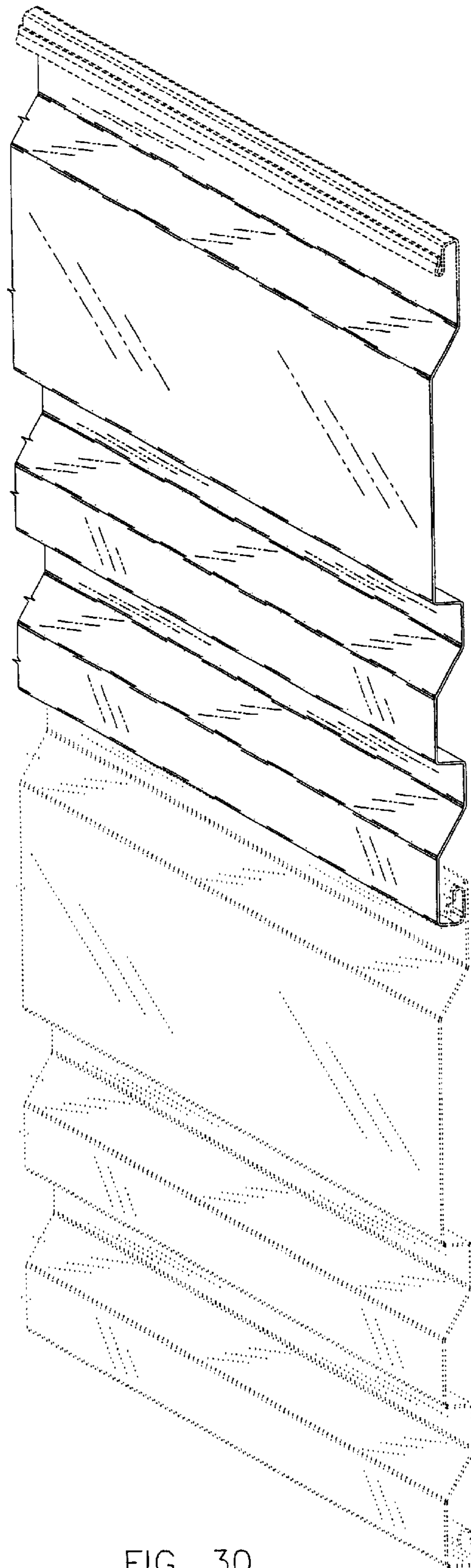

FIG. 30

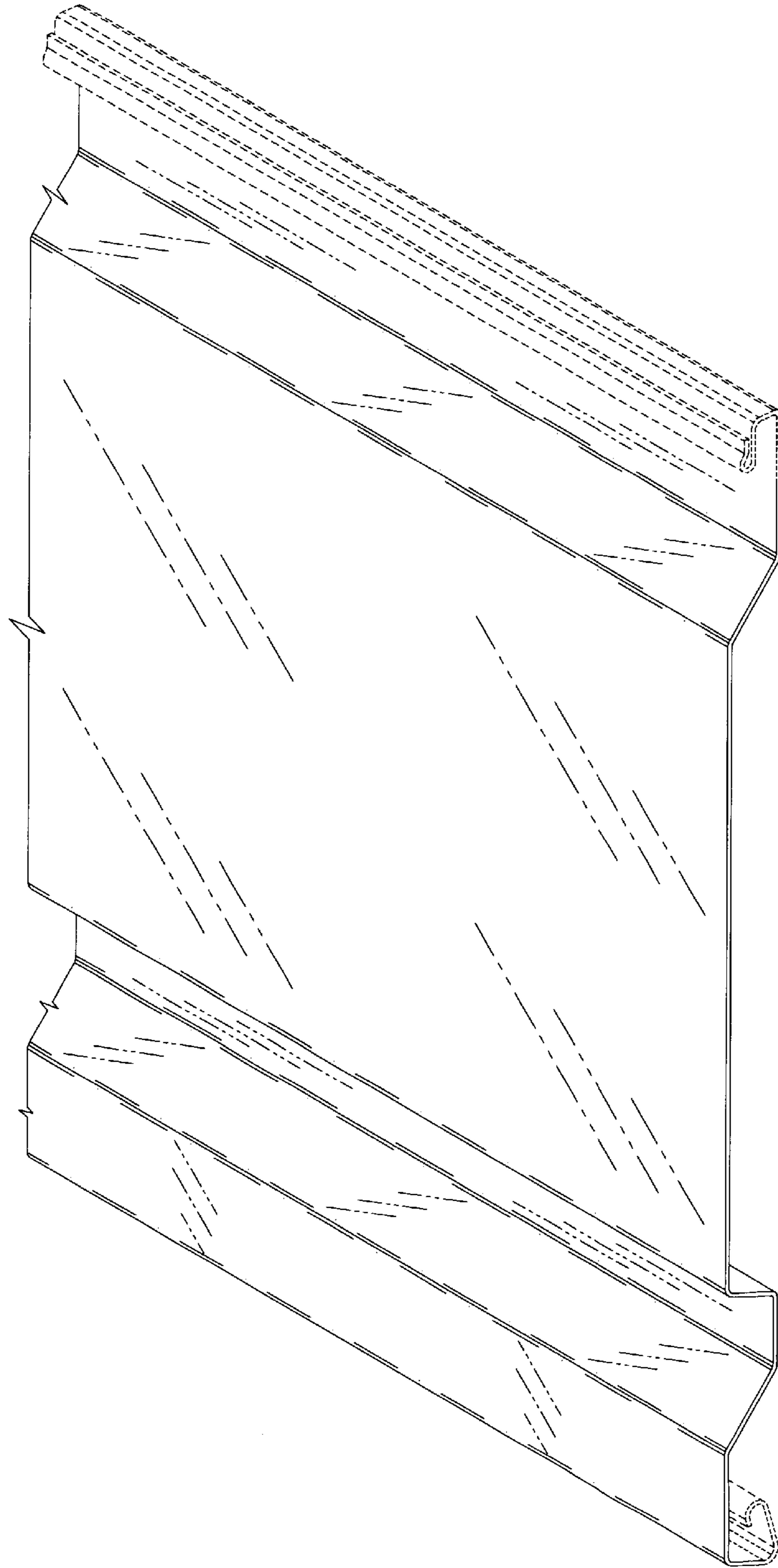

FIG. 31

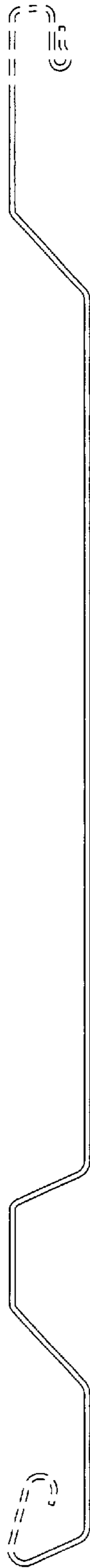

FIG. 32

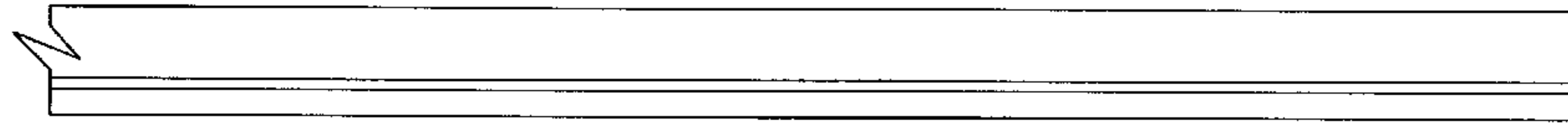

FIG. 35

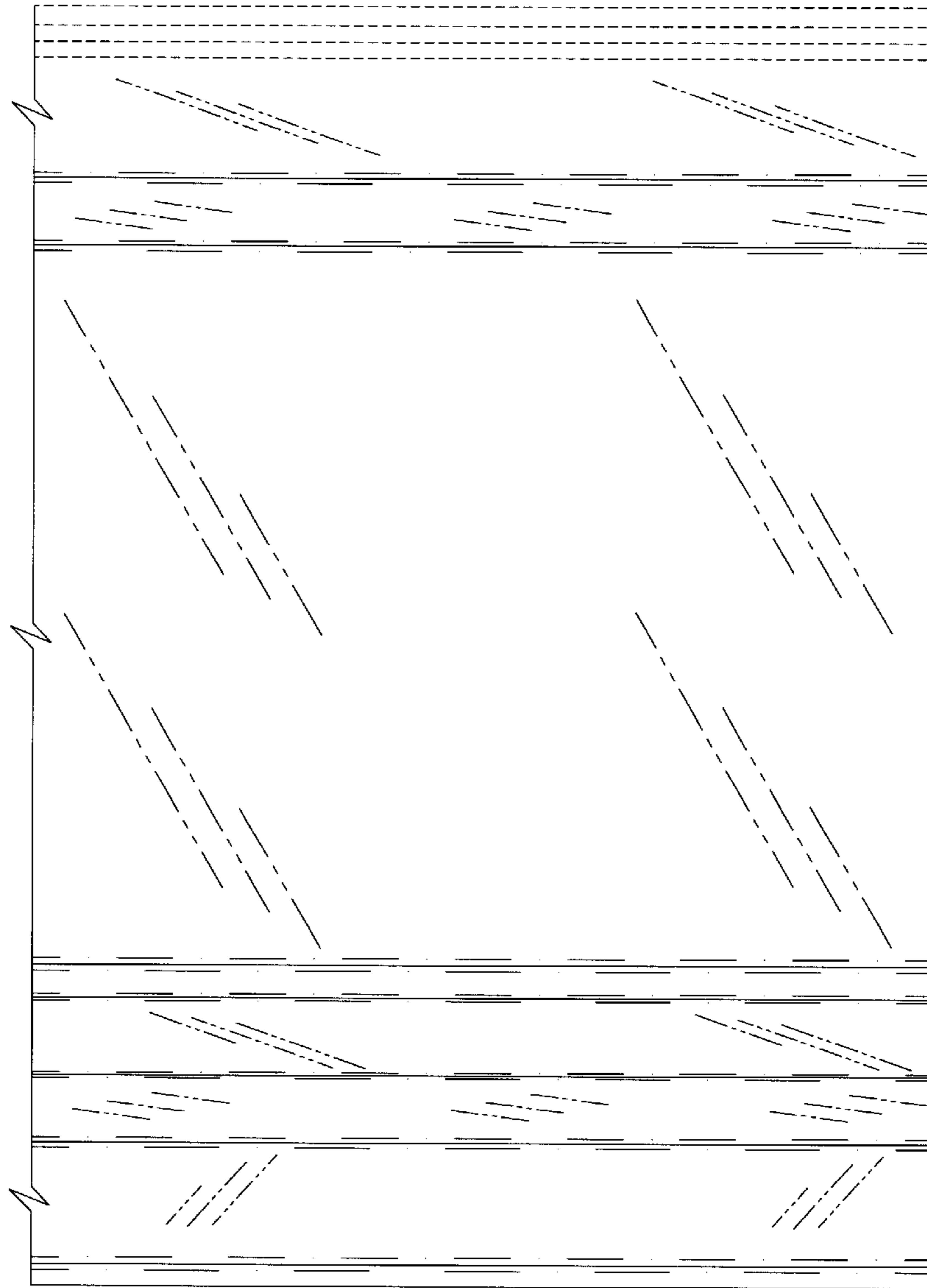

FIG. 33

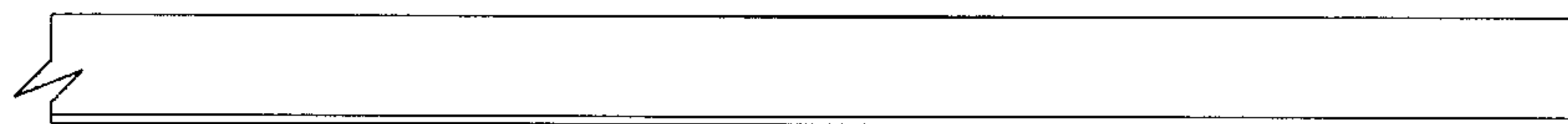

FIG. 34

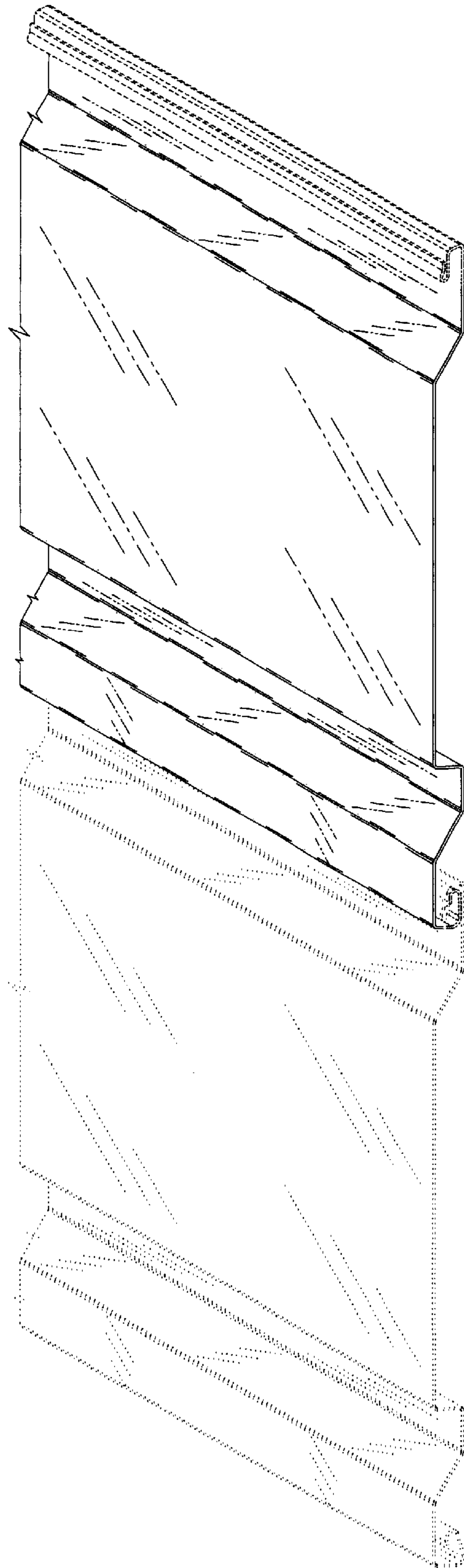

FIG. 36

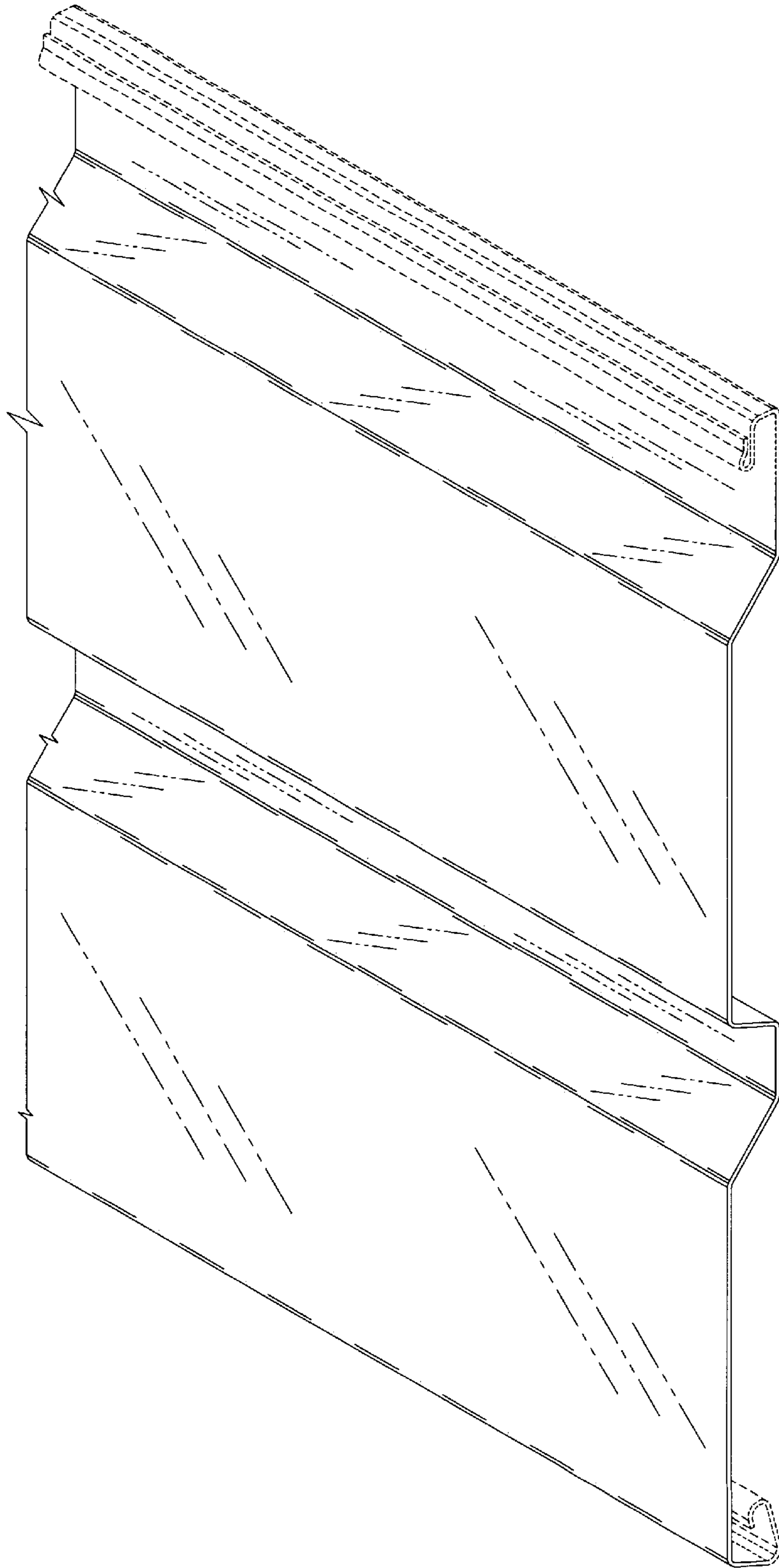

FIG. 37



FIG. 38

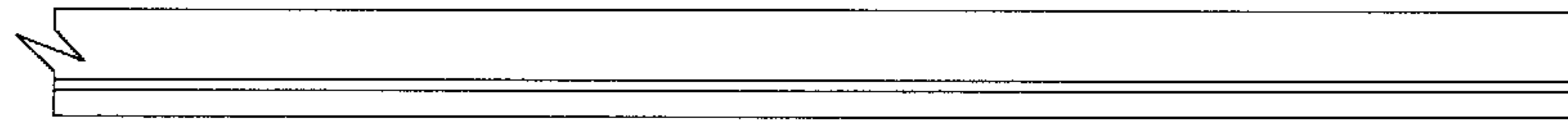

FIG. 41

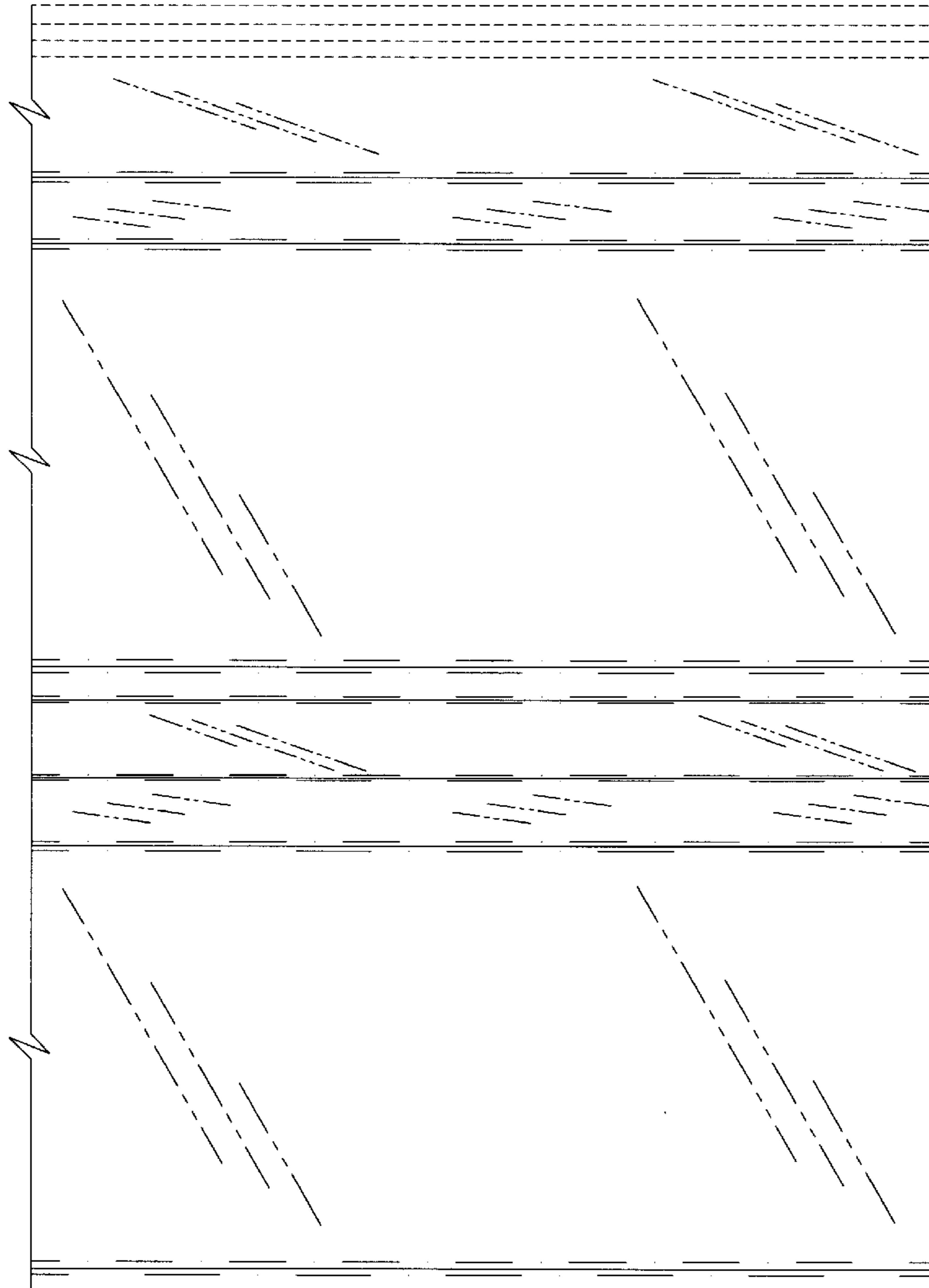

FIG. 39



FIG. 40

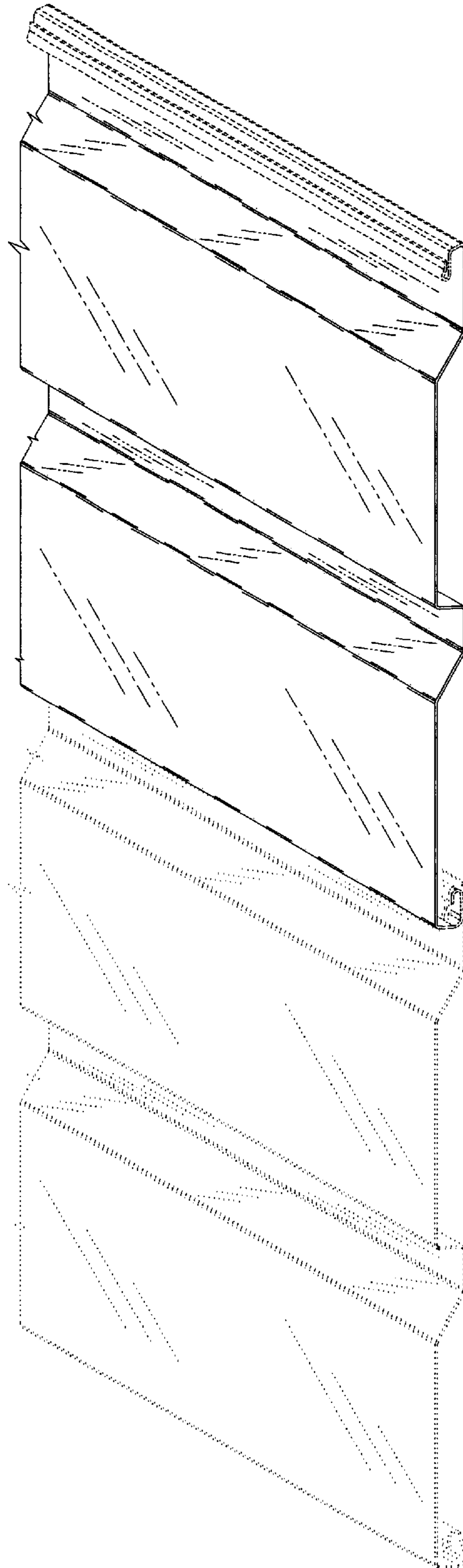

FIG. 42