

US00D527655S

(12) **United States Design Patent**
Dias

(10) **Patent No.:** **US D527,655 S**

(45) **Date of Patent:** **** Sep. 5, 2006**

(54) **WATCH CASE**

(76) **Inventor:** **M. Carlos Dias**, 19, rue du
Grand-Bureau, 1227 Geneva (CH)

(**) **Term:** **14 Years**

(21) **Appl. No.:** **29/203,297**

(22) **Filed:** **Apr. 13, 2004**

(30) **Foreign Application Priority Data**

Oct. 23, 2003 (WO) DMA/006 180

(51) **LOC (8) Cl.** **10-02**

(52) **U.S. Cl.** **D10/38**

(58) **Field of Classification Search** D10/30-39,
D10/122-132; 368/276-278, 281-283, 285,
368/286, 294, 295, 82-84, 28-30, 37, 21,
368/239-242, 223, 228, 232, 80, 110, 113;
224/164, 168, 175

See application file for complete search history.

(56) **References Cited**

U.S. PATENT DOCUMENTS

1,340,003 A * 5/1920 Benjamin et al. 368/281
1,385,839 A * 7/1921 Lewitt 368/281
1,400,083 A * 12/1921 Lehr 368/281
1,618,452 A * 2/1927 Lehr 368/281
1,644,802 A * 10/1927 Vermot 368/281

4,982,388 A * 1/1991 Erard 368/223
D321,834 S * 11/1991 Saint-Dizier D10/39
D430,043 S * 8/2000 Schopfer D10/39
D497,109 S * 10/2004 Itsubo D10/30

OTHER PUBLICATIONS

Goldschmiede Zietung, Jan., 1988, p. 64, watch.*

* cited by examiner

Primary Examiner—Lucy Lieberman

(74) *Attorney, Agent, or Firm*—Strum & Fix LLP

(57) **CLAIM**

The ornamental design for a watch case, as shown and described.

DESCRIPTION

FIG. 1 is a rear elevational view of the watch case showing my new design;

FIG. 2 is a left side elevational view thereof;

FIG. 3 is a front elevational view thereof;

FIG. 4 is a right side elevational view thereof;

FIG. 5 is a top plan view thereof;

FIG. 6 is a bottom plan view thereof;

FIG. 7 is an upper left hand perspective view thereof; and,

FIG. 8 is a bottom perspective view thereof showing the watch case.

1 Claim, 1 Drawing Sheet

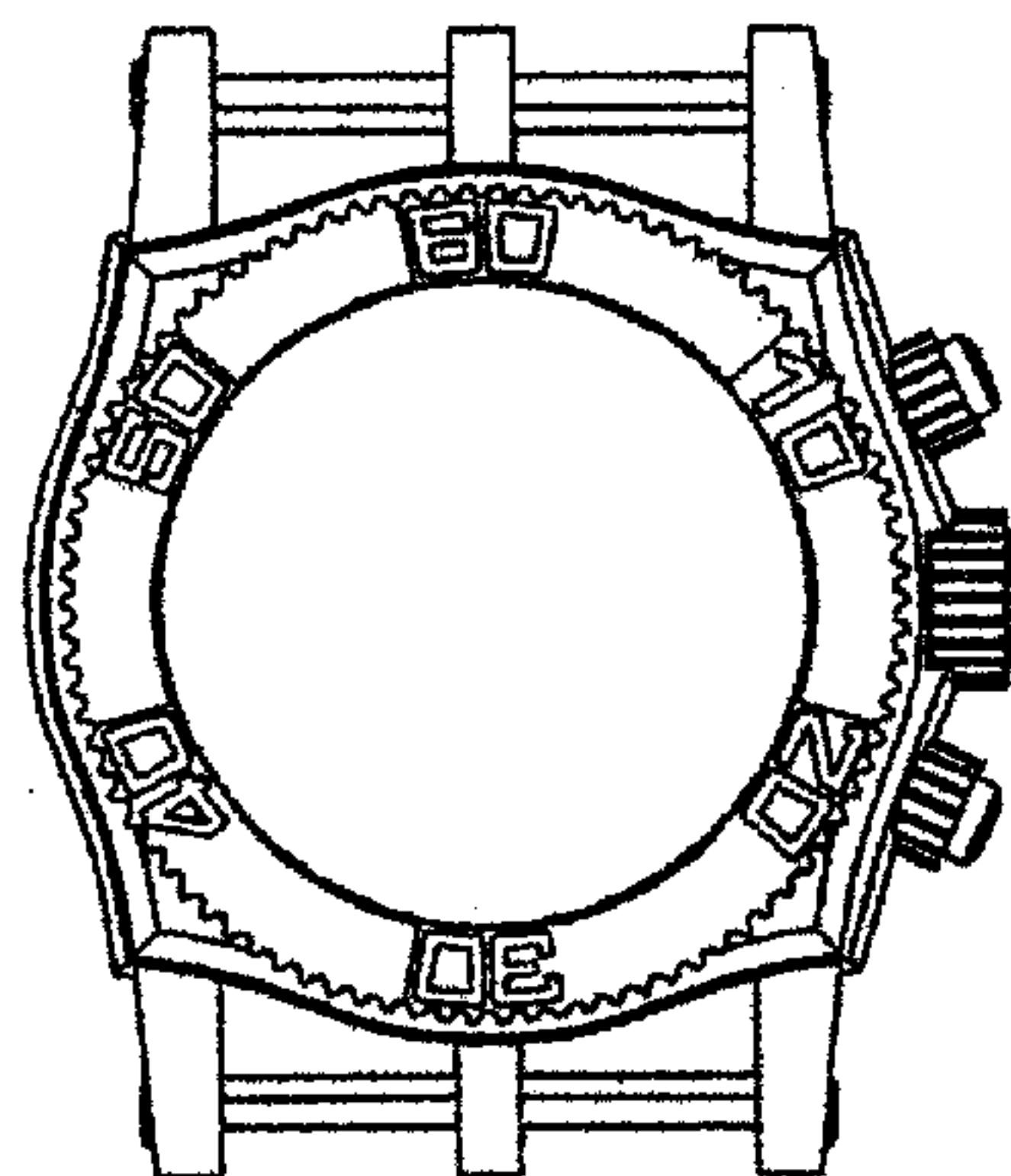

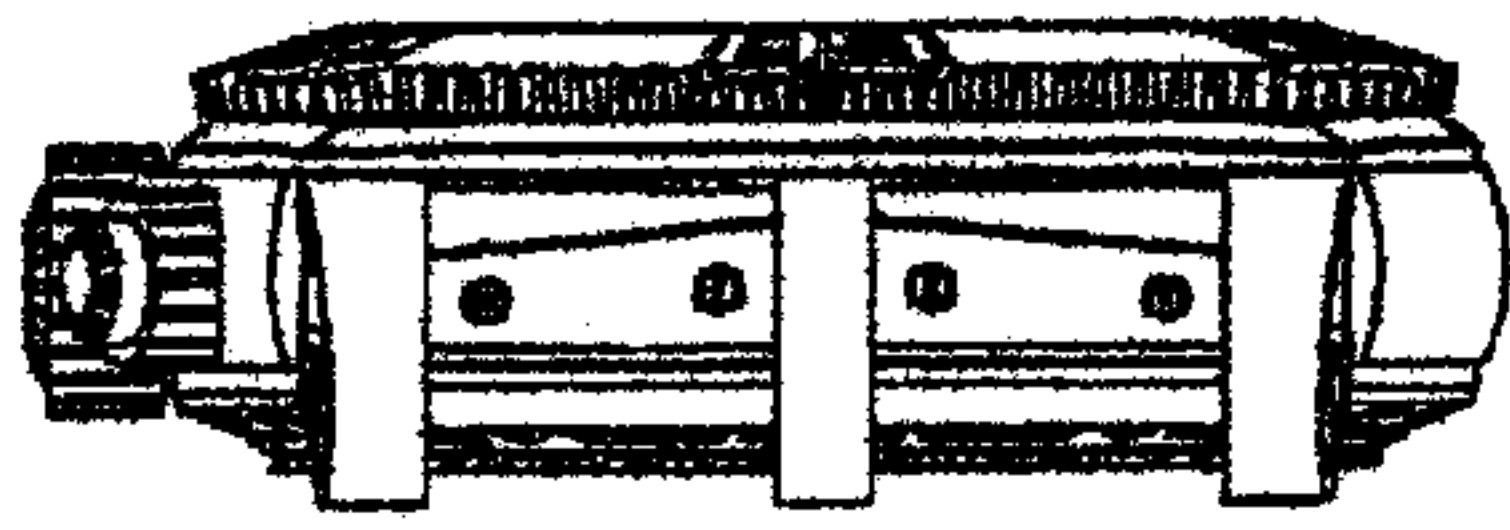

Fig. 1

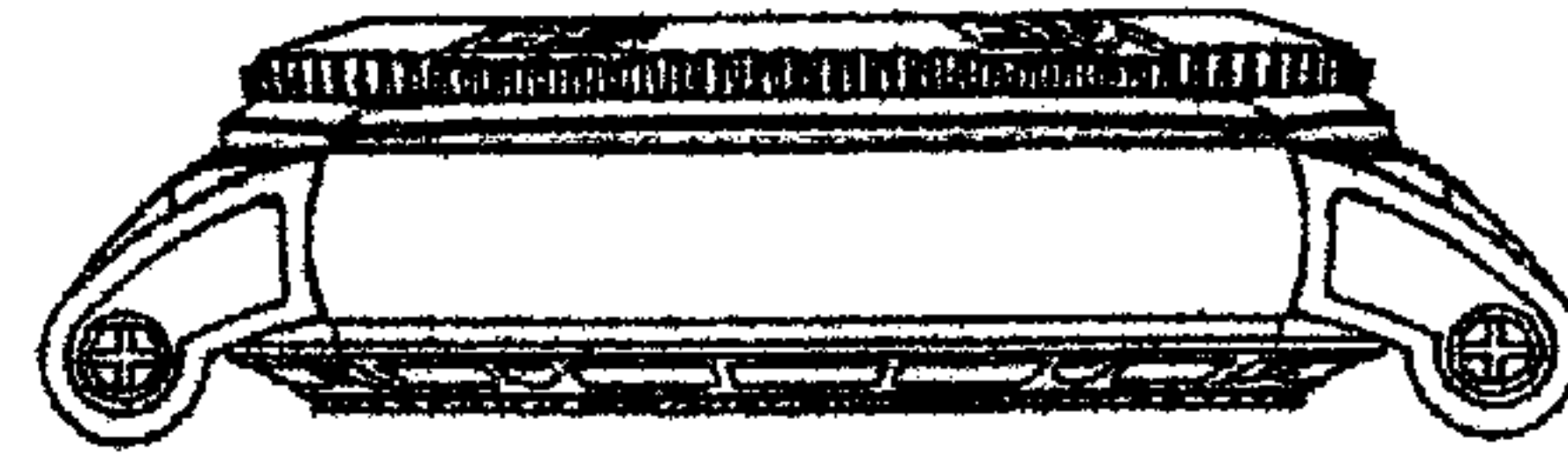

Fig. 2

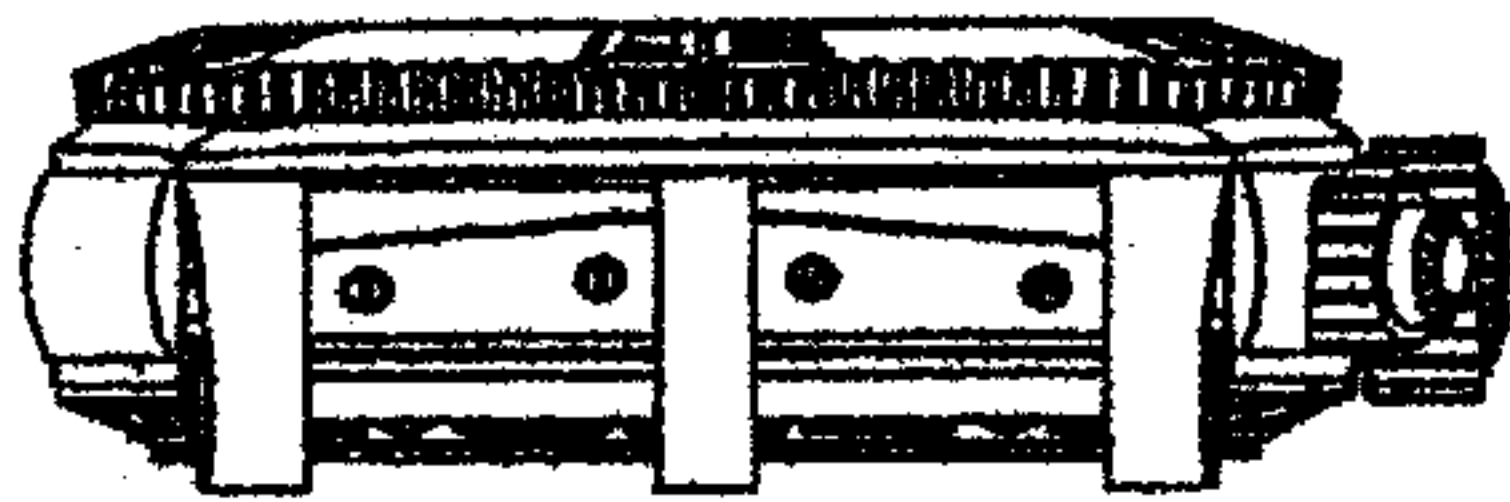

Fig. 3



Fig. 4

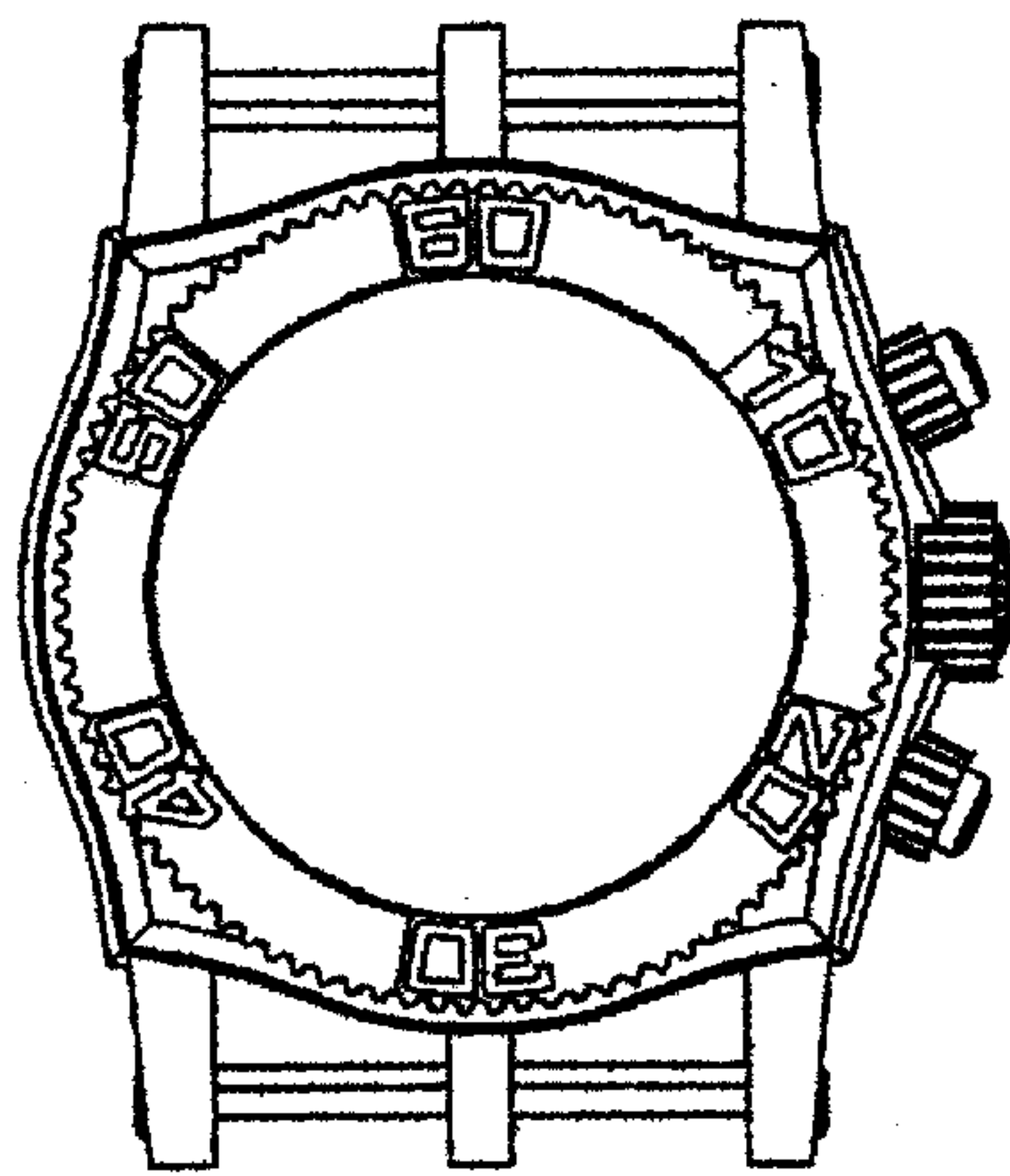

Fig. 5

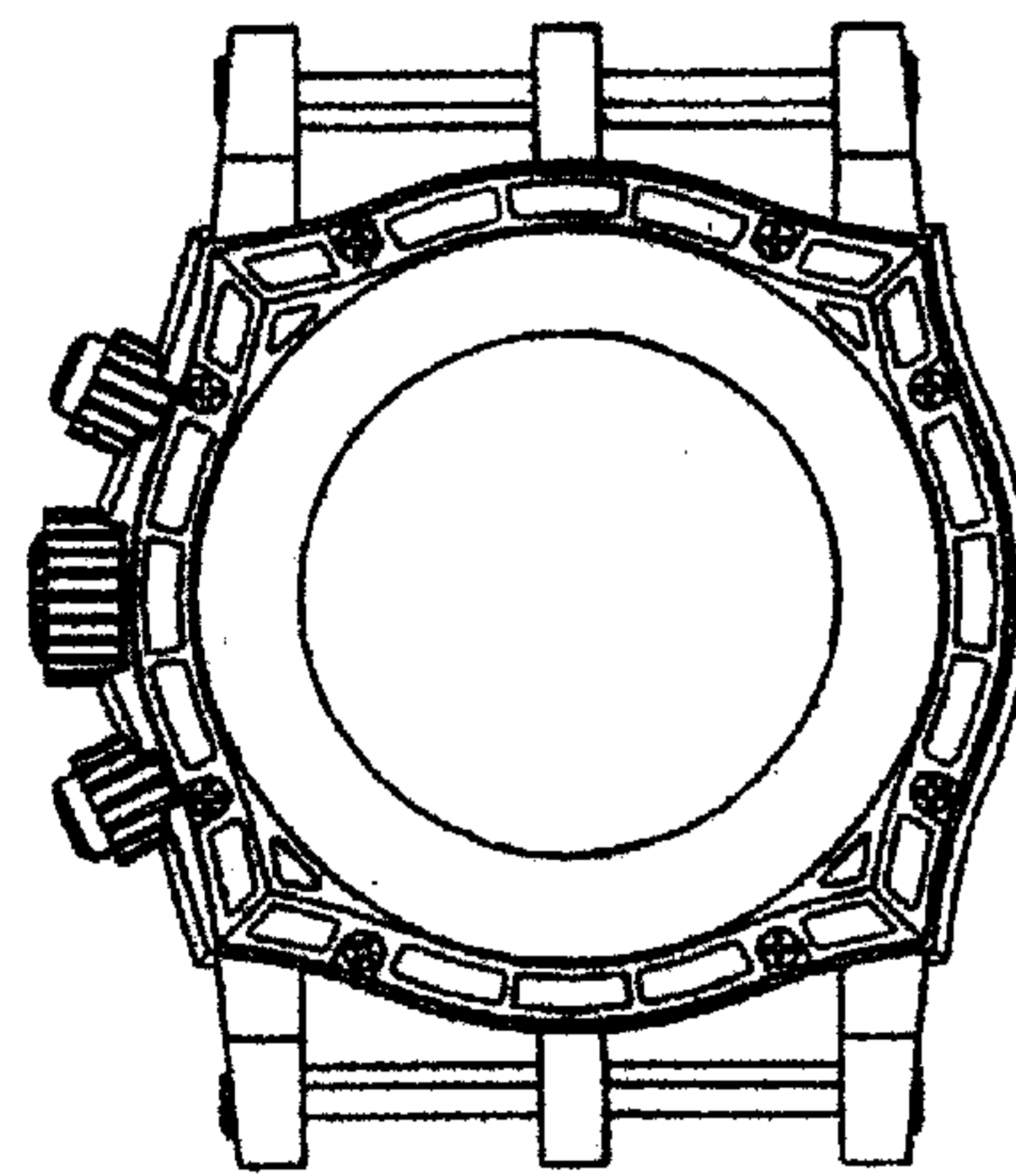

Fig. 6

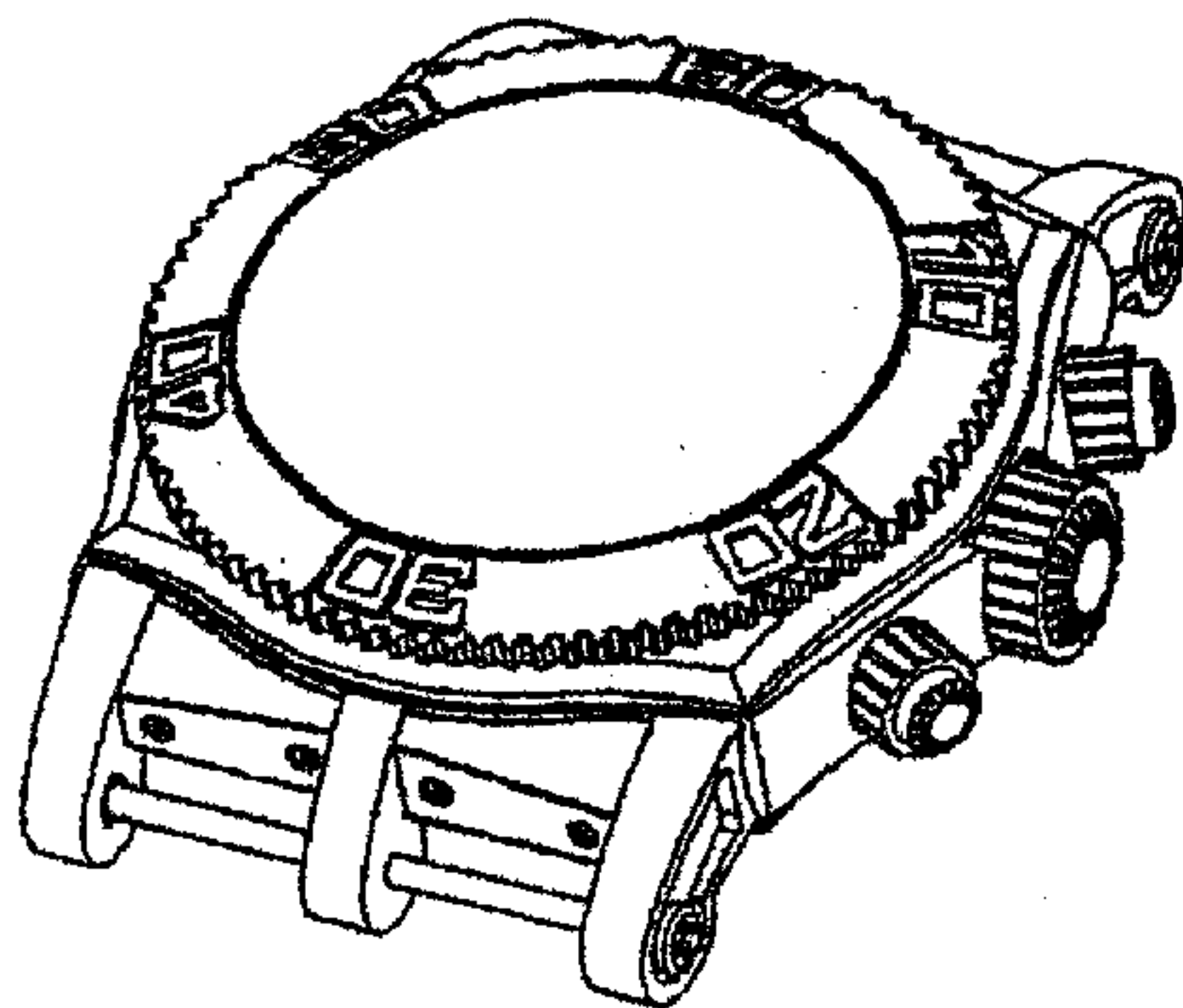

Fig. 7

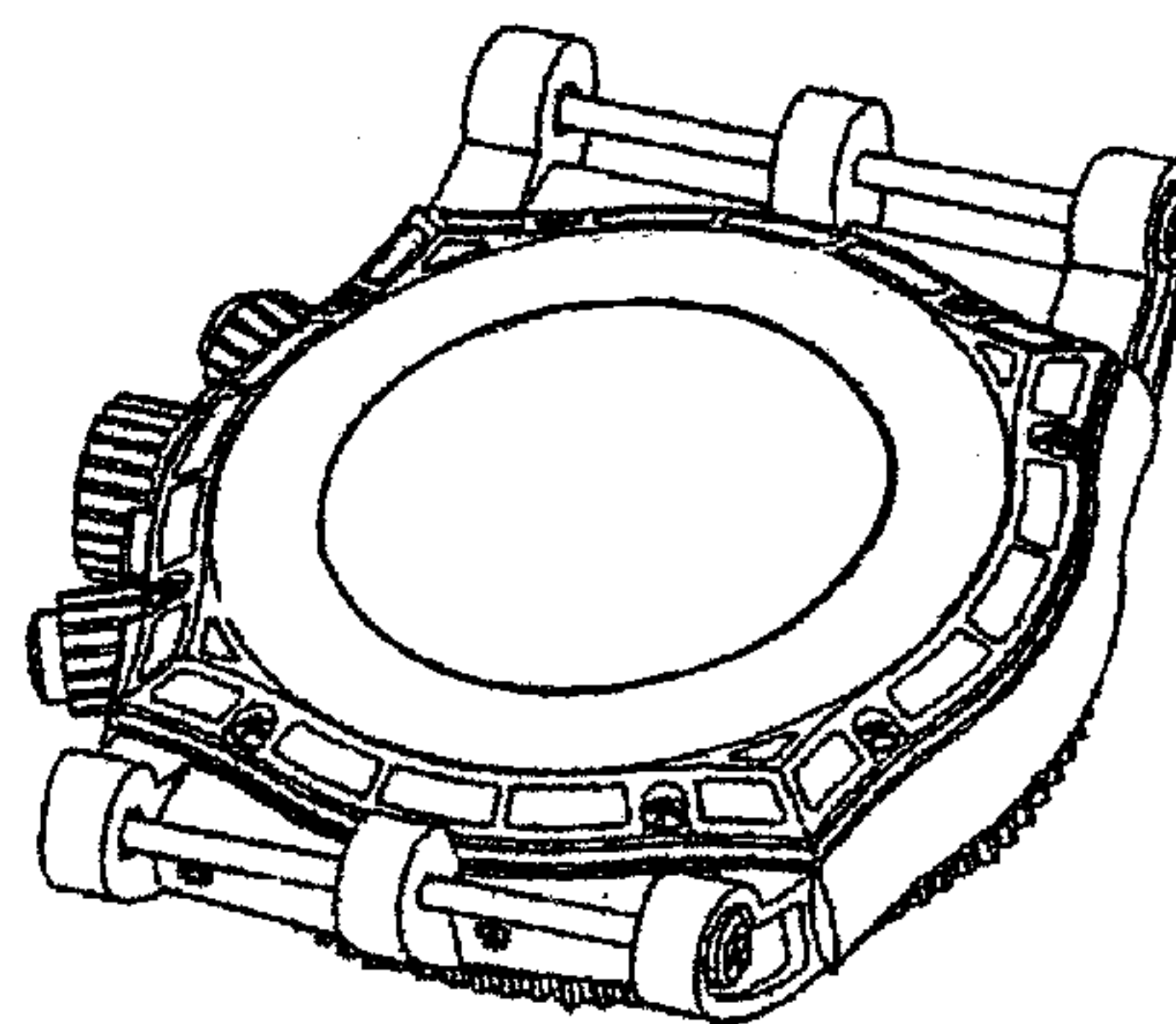

Fig. 8