



US00D527516S

(12) **United States Design Patent** (10) **Patent No.:** **US D527,516 S**
Kayano et al. (45) **Date of Patent:** **** Sep. 5, 2006**

(54) **PORTION OF A SHOE UPPER**

(75) Inventors: **Toshikazu Kayano**, Kobe (JP);
Kiyomitsu Kurosaki, Kobe (JP)

(73) Assignee: **ASICS Corporation**, Kobe (JP)

(**) Term: **14 Years**

(21) Appl. No.: **29/235,248**

(22) Filed: **Aug. 1, 2005**

Related U.S. Application Data

(62) Division of application No. 29/195,359, filed on Dec. 11, 2003, now Pat. No. Des. 518,283.

(30) **Foreign Application Priority Data**

Jul. 18, 2003	(JP)	2003-020991
Jul. 18, 2003	(JP)	2003-020997
Jul. 18, 2003	(JP)	2003-021024
Jul. 18, 2003	(JP)	2003-021025
Jul. 18, 2003	(JP)	2003-021026
Jul. 18, 2003	(JP)	2003-021027
Jul. 18, 2003	(JP)	2003-021028
Jul. 18, 2003	(JP)	2003-021029
Jul. 18, 2003	(JP)	2003-021030
Jul. 18, 2003	(JP)	2003-021031
Jul. 18, 2003	(JP)	2003-021032
Jul. 18, 2003	(JP)	2003-021033

(51) **LOC (8) Cl.** **02-99**

(52) **U.S. Cl.** **D2/972**

(58) **Field of Classification Search** D2/902,
D2/907, 908, 943, 944, 969, 972-974; 36/45,
36/50.1, 77 M, 77 R, 83, 88, 113, 114, 126-131
See application file for complete search history.

(56) **References Cited**

U.S. PATENT DOCUMENTS

D498,579 S * 11/2004 Lemaster D2/972

* cited by examiner

Primary Examiner—Dominic Simone

(74) *Attorney, Agent, or Firm*—Michael E. Zall

(57) **CLAIM**

We claim the ornamental design for the portion of a shoe upper, as shown and described.

DESCRIPTION

FIG. 1 is a perspective view of a portion of a shoe upper as seen from the top, front and right sides wherein the broken line work is for environmental purposes only and does not constitute a part of the claimed design;

FIG. 2 is an enlarged perspective view thereof;

FIG. 3 is a right side elevational view thereof;

FIG. 4 is a cross-sectional view thereof, taken along section line 4—4 of FIG. 3,

FIG. 5 is a perspective view of second embodiment of FIG. 1, as seen from the top, front and right sides wherein the broken line work is for environmental purposes only and does not constitute a part of the claimed design;

FIG. 6 is an enlarged perspective view thereof,

FIG. 7 is a right side elevational view thereof; and,

FIG. 8 is a cross-sectional view thereof, taken along section line 8—8 of FIG. 7.

The shoe upper for the other foot is the mirror image of that shown.

1 Claim, 8 Drawing Sheets

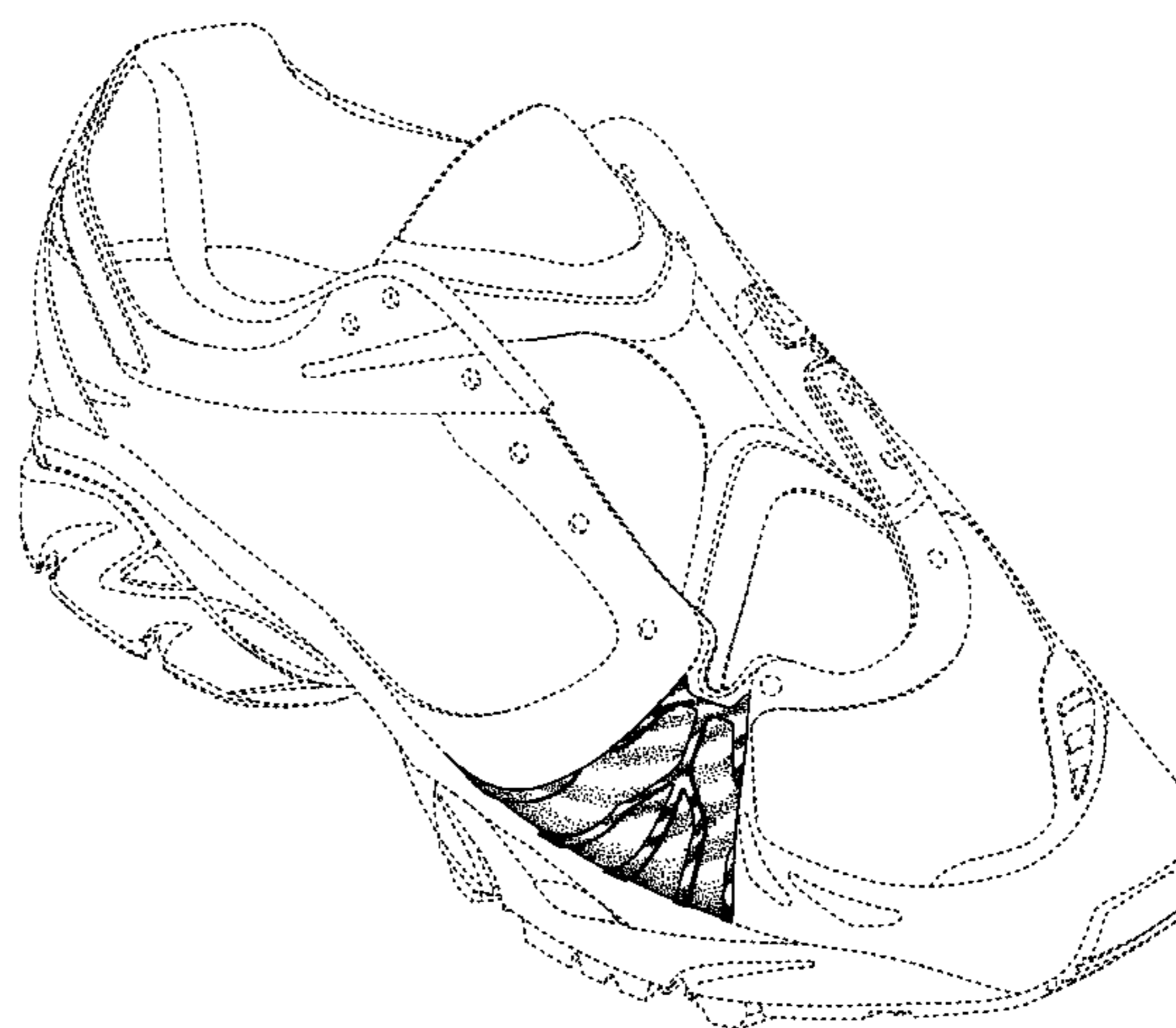
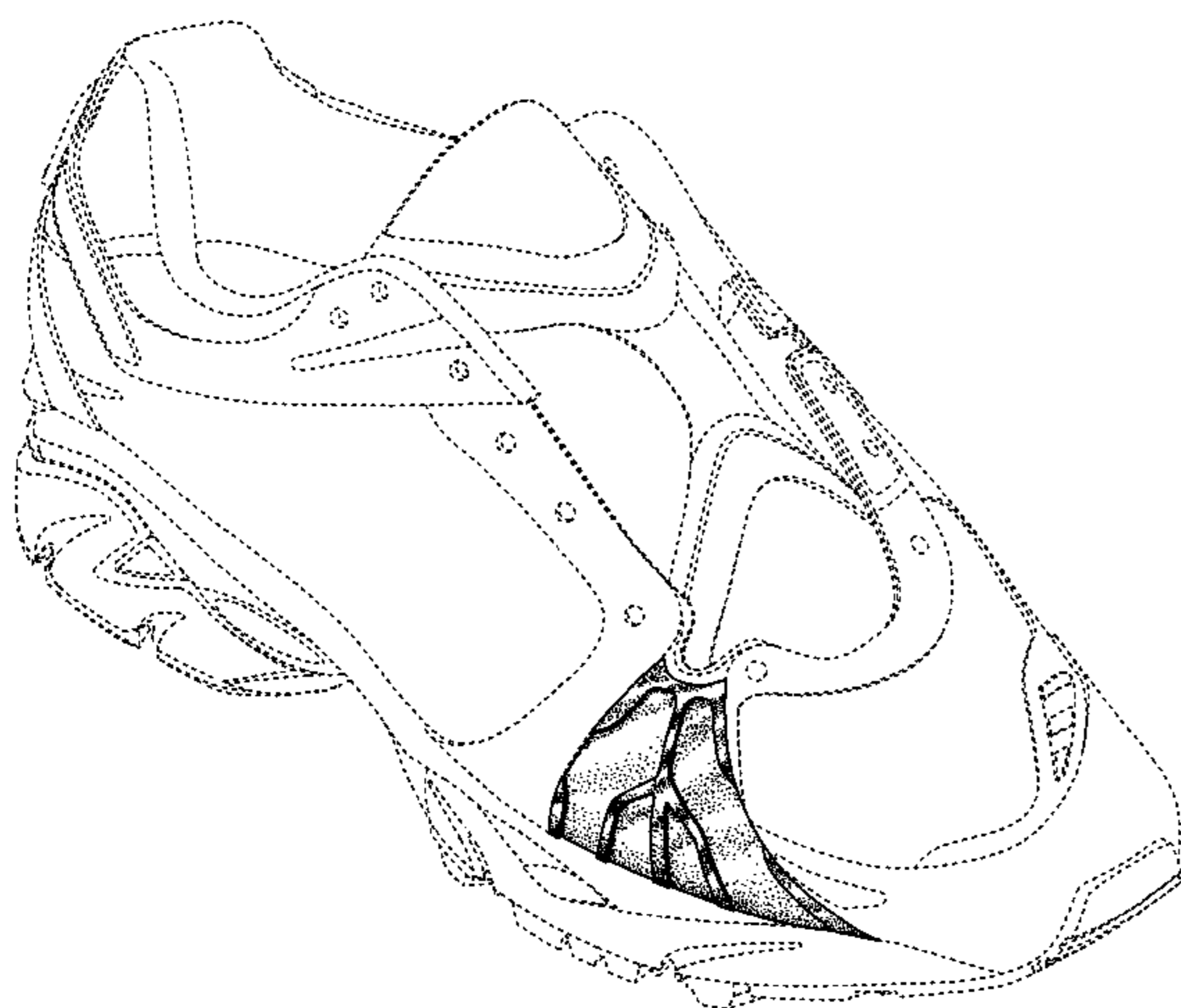

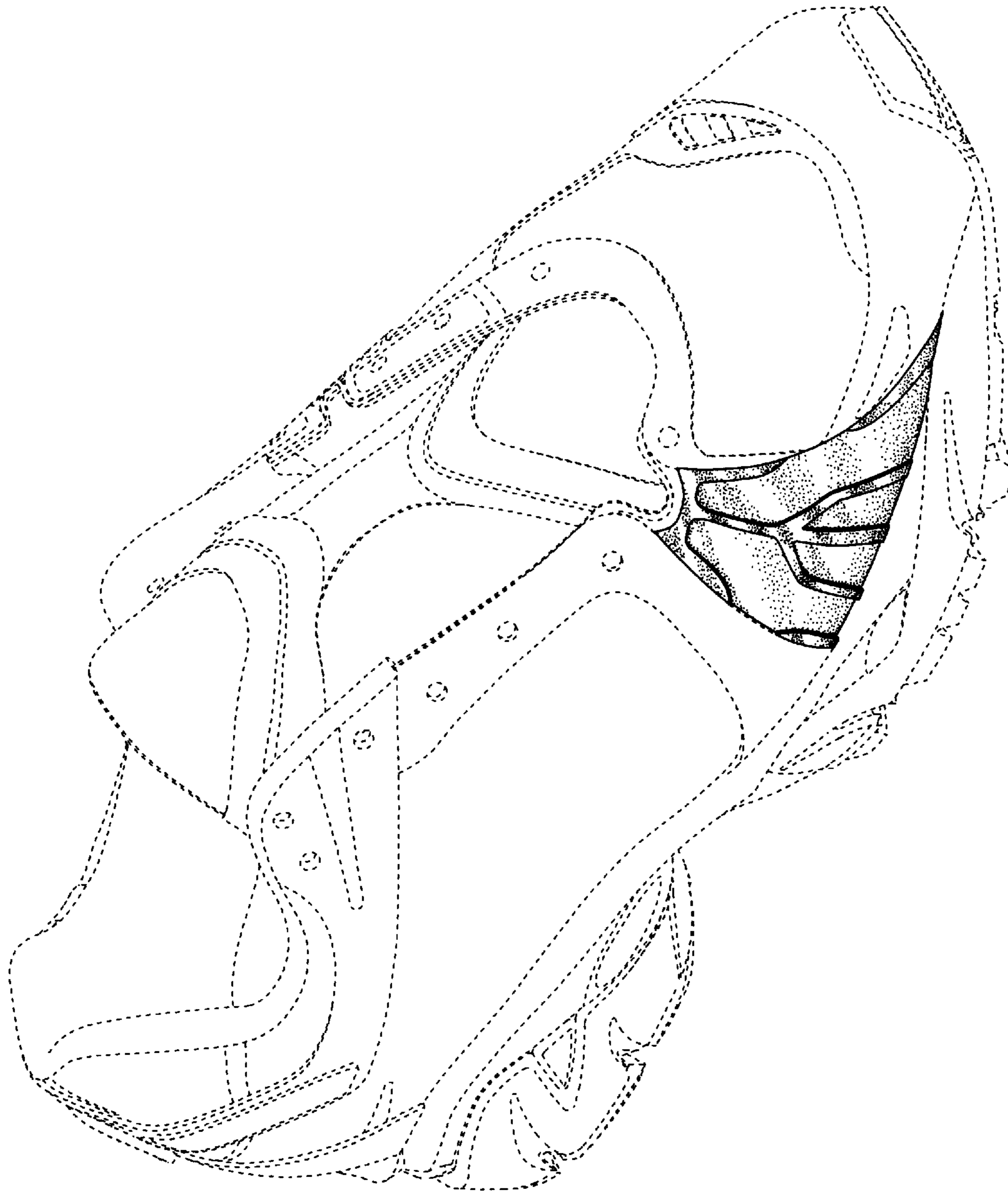

FIG. 1

FIG. 2

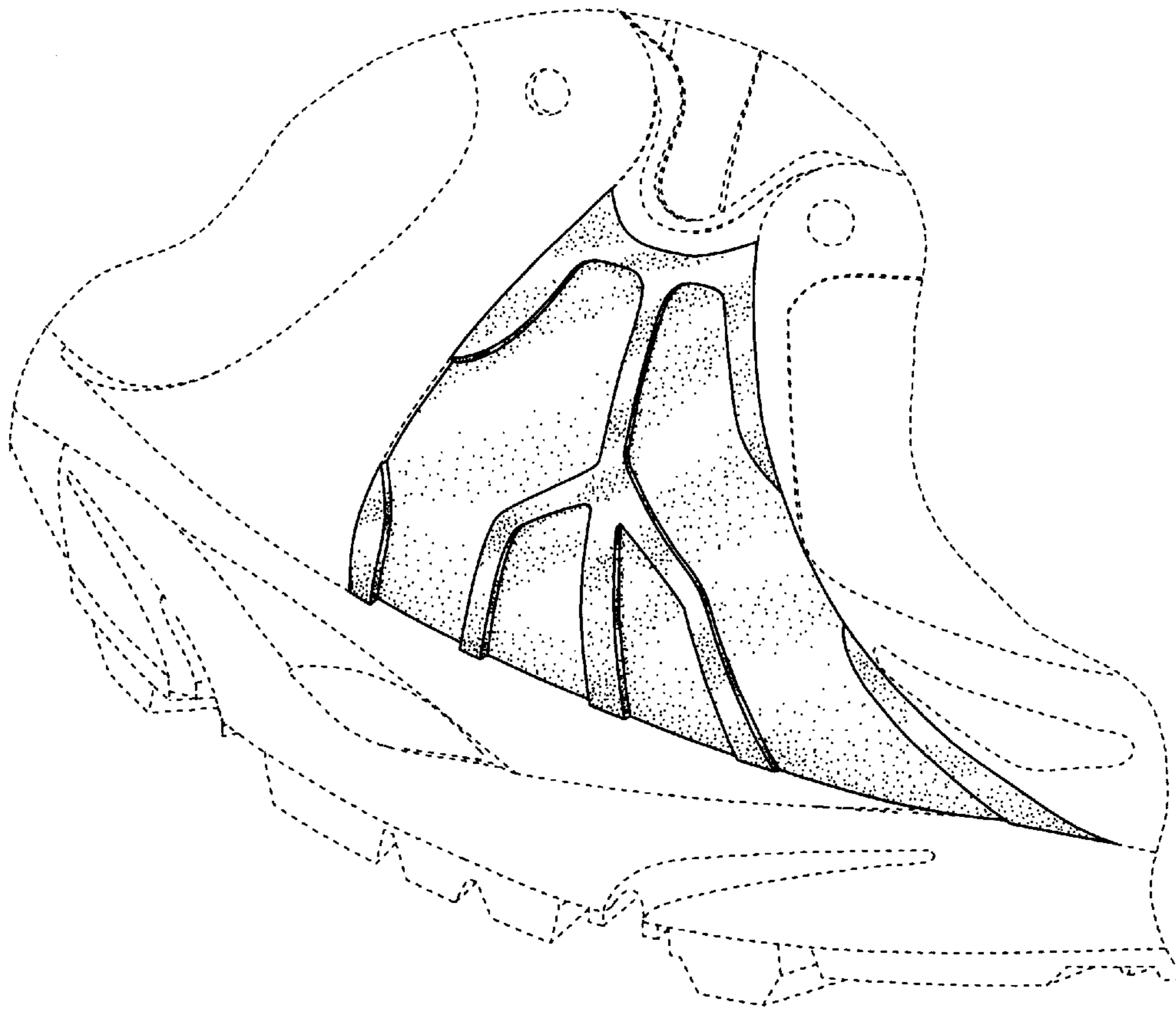

FIG. 3

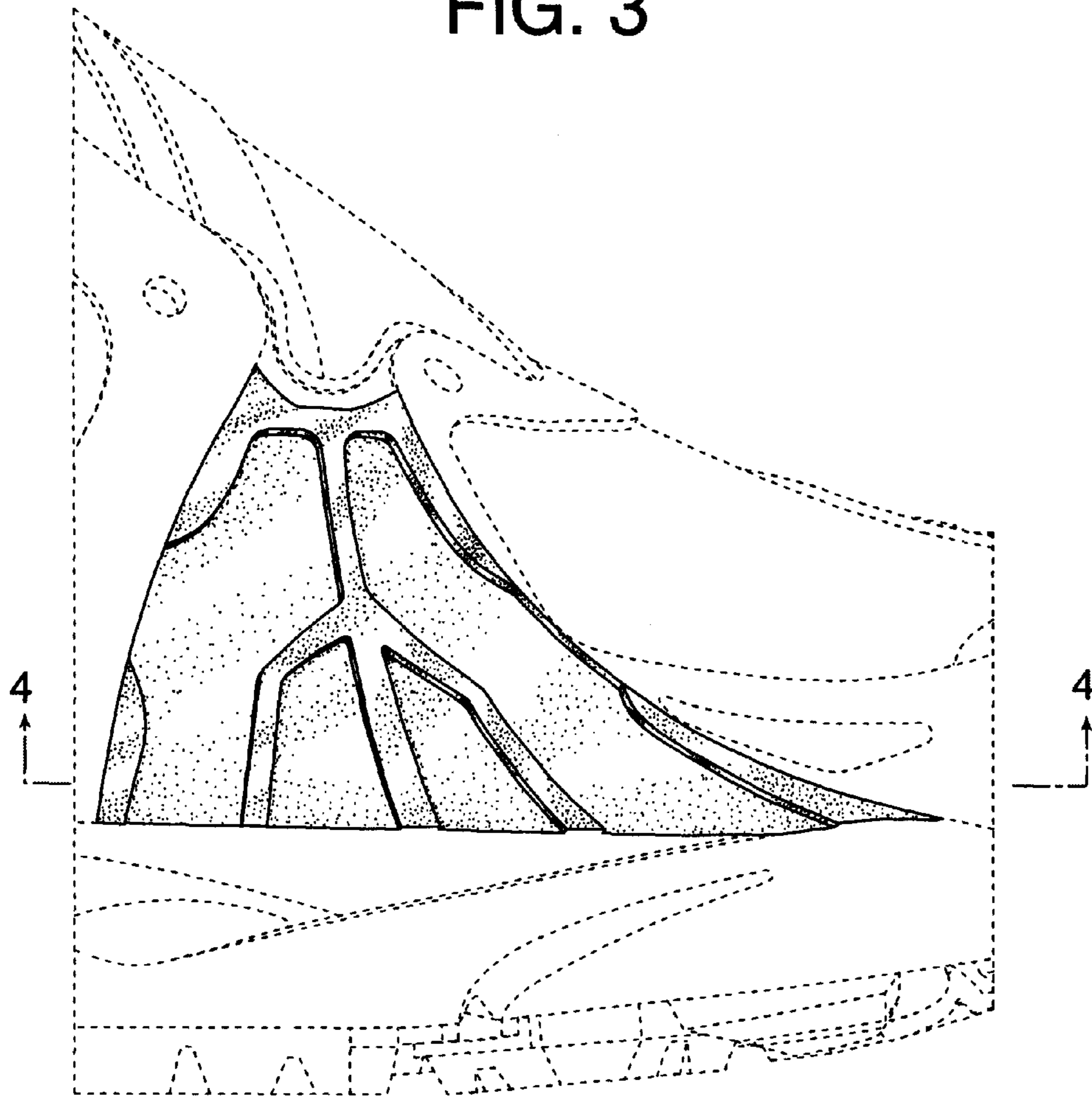
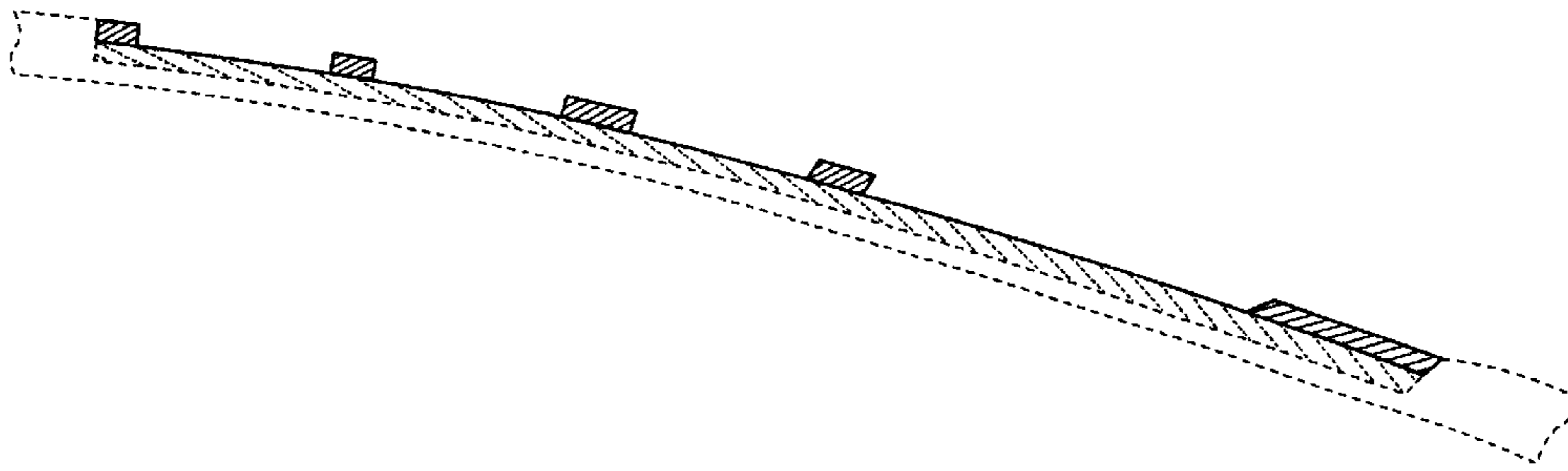

FIG. 4



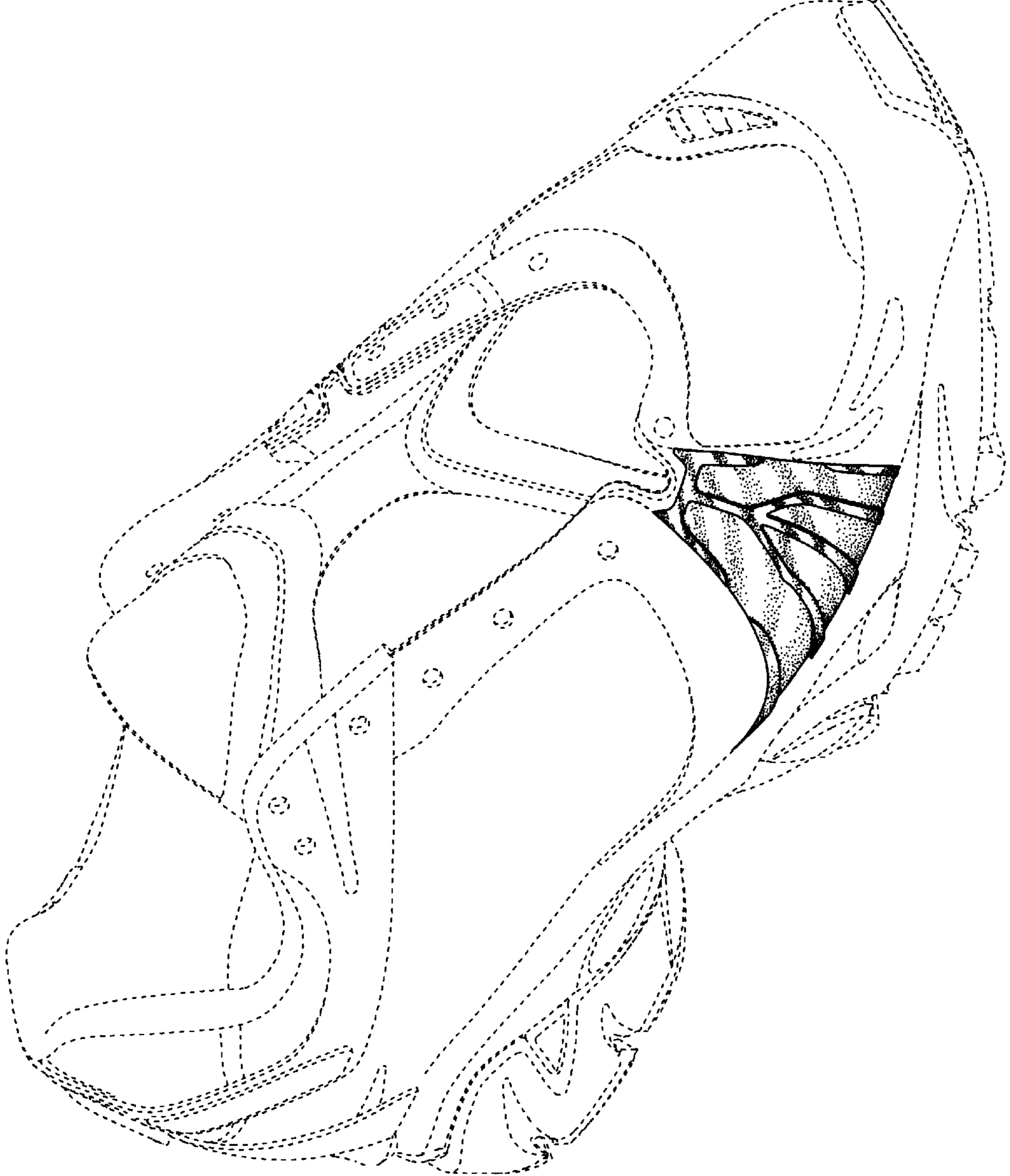

FIG. 5

FIG. 6

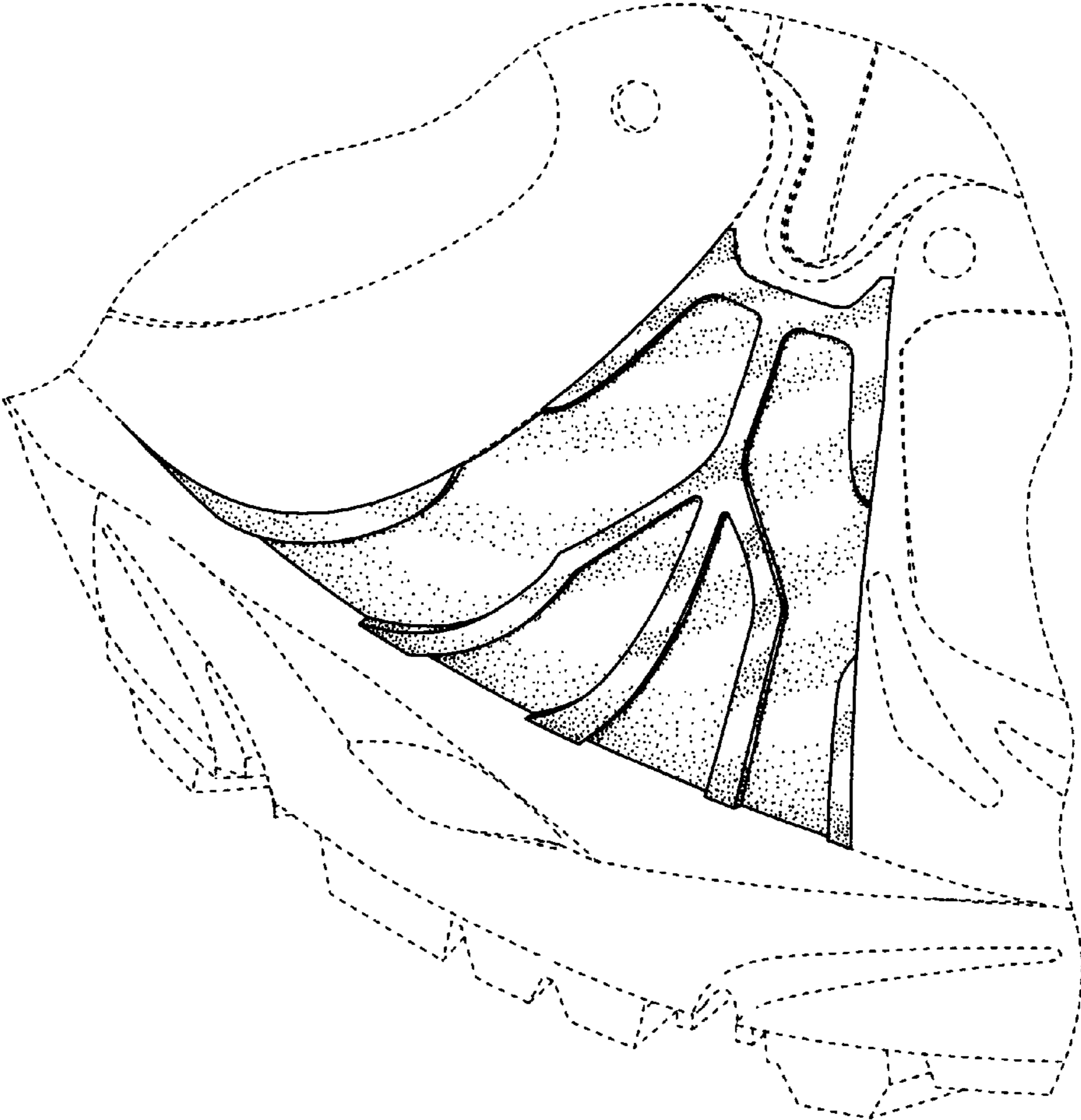

FIG. 7

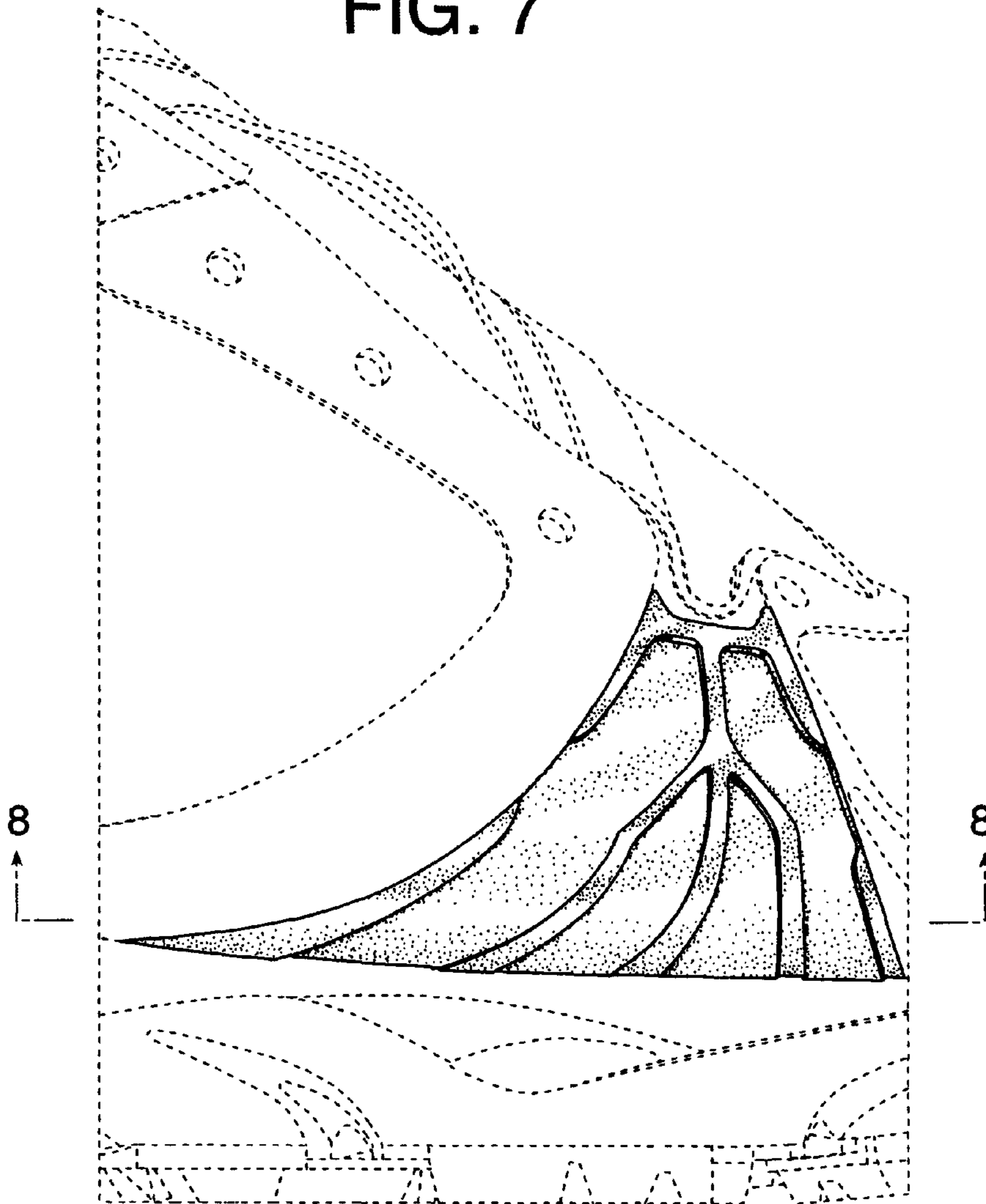

FIG. 8

