

US00D527501S

(12) **United States Design Patent**  
**Tai**

(10) **Patent No.:** **US D527,501 S**

(45) **Date of Patent:** **\*\* Aug. 29, 2006**

(54) **HANDHELD VACUUM WITH WINDOW**

(75) Inventor: **Yung Sze Tai**, Kowloon (HK)

(73) Assignee: **AK Industrial Co., Ltd.**, Hong Kong (HK)

(\*\*) Term: **14 Years**

(21) Appl. No.: **29/226,947**

(22) Filed: **Apr. 4, 2005**

(51) **LOC (8) Cl.** ..... **15-05**

(52) **U.S. Cl.** ..... **D32/18**

(58) **Field of Classification Search** ..... D32/15-18,  
D32/21, 22-24, 31; 15/314, 324, 344, 329,  
15/347, 320-321, 412, DIG. 1, 353-354,  
15/301, 385, 93.1, 405, 330, 415.1, 327.5,  
15/323

See application file for complete search history.

(56) **References Cited**

**U.S. PATENT DOCUMENTS**

4,373,228 A	2/1983	Dyson
D280,452 S	9/1985	Arita
D294,412 S	2/1988	Sadashima et al.
D302,876 S	8/1989	Ikeda et al.
D304,104 S	10/1989	Busalt et al.
D306,505 S	3/1990	Bradd
D307,657 S	5/1990	Li
D320,099 S	9/1991	Case et al.
D326,169 S	5/1992	Stützer et al.
D376,228 S	12/1996	Bass et al.
D379,691 S	6/1997	Moine et al.
D387,516 S	12/1997	Murray et al.
D401,021 S	11/1998	Stephens et al.
D418,262 S	12/1999	Yuen

(Continued)

**FOREIGN PATENT DOCUMENTS**

JP 1050612 5/1990

**OTHER PUBLICATIONS**

U.S. Appl. No. 29/176,115, filed Feb. 18, 2003, Ma, Rotary Brush Vacuum Cleaner.

U.S. Appl. No. 29/176,440, filed Feb. 21, 2003, Cheng, Handheld Brush Vacuum.

U.S. Appl. No. 29/181,964, filed May 16, 2003, Ma, Handheld Rotary Vacuum.

U.S. Appl. No. 10/100,727, filed Mar. 20, 2002, Ma, Electric Rotary Brush Module.

Prior to Sep. 14, 2004, Royal Appliance Mfg. Co., Electric Rotary Brush Module.

*Primary Examiner*—Ruth McInroy

(74) *Attorney, Agent, or Firm*—Roy, Kiesel et al.

(57) **CLAIM**

I claim the ornamental design for a handheld vacuum with window, as shown and described.

**DESCRIPTION**

FIG. 1 is a perspective view of a handheld vacuum with window incorporating the inventive design;

FIG. 2 is a top view thereof;

FIG. 3 is a left view thereof;

FIG. 4 is a front end view thereof;

FIG. 5 is a rear end view thereof;

FIG. 6 is a right view thereof; and,

FIG. 7 is a bottom view thereof.

**1 Claim, 6 Drawing Sheets**

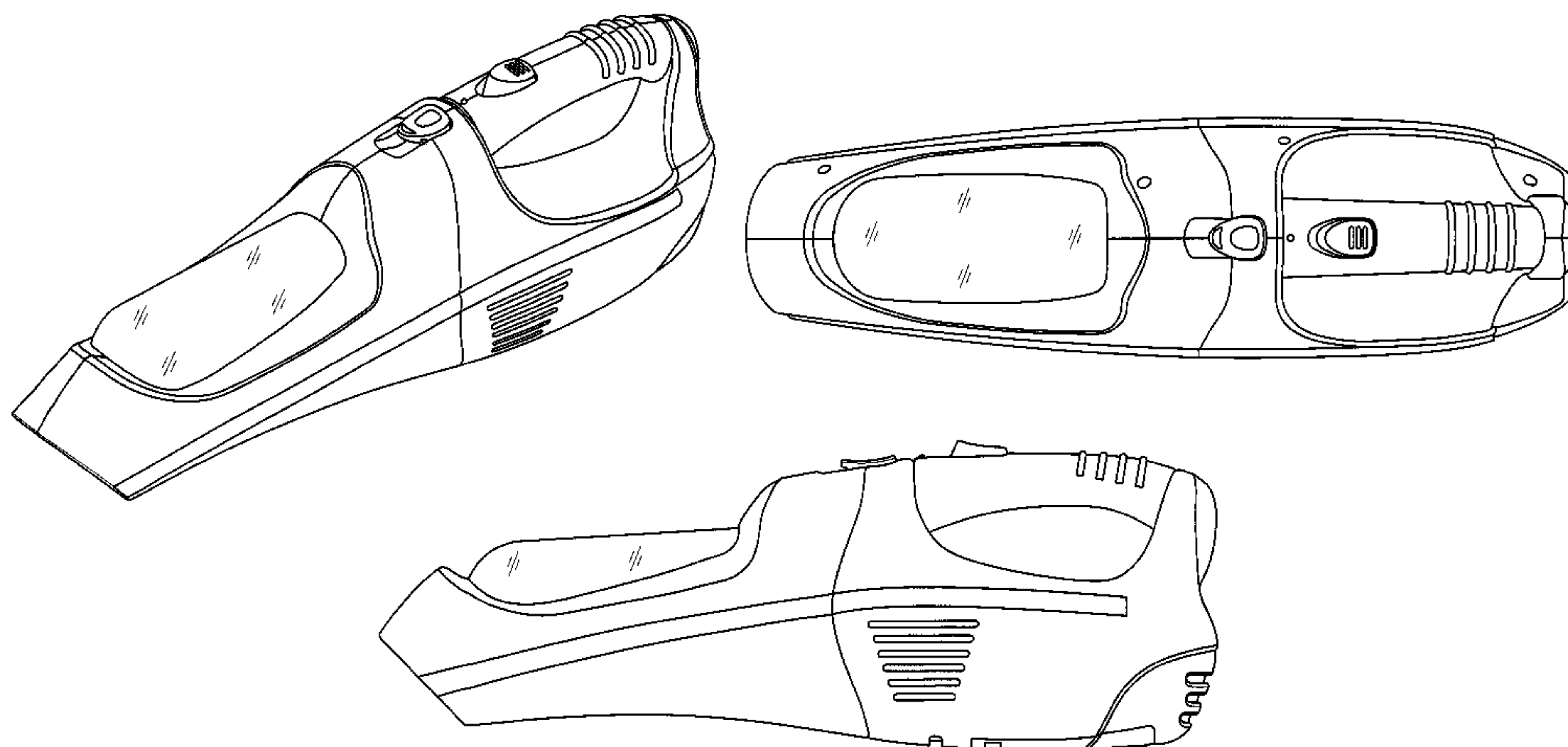

# US D527,501 S

Page 2

---

## U.S. PATENT DOCUMENTS

D421,671 S	3/2000	Thomas	6,481,043 B1	11/2002	Anderson et al.	
D432,743 S	10/2000	Santiago	D468,068 S	12/2002	Mok	
D437,983 S	2/2001	Stratford	D471,331 S	3/2003	Pan	
D440,719 S	4/2001	Stratford	D480,845 S	* 10/2003	Ki .....	D32/18
D440,720 S	4/2001	Stratford	D481,842 S	11/2003	Tai	
D441,151 S	4/2001	Stratford	D483,533 S	* 12/2003	Ki .....	D32/18
D441,152 S	4/2001	Stratford	D489,849 S	* 5/2004	Ki .....	D32/18
D441,926 S	5/2001	Stratford	D501,065 S	* 1/2005	Ma .....	D32/18
6,231,647 B1	5/2001	Cheng	D507,385 S	* 7/2005	Ma .....	D32/18
D448,894 S	10/2001	Yuen	D509,931 S	* 9/2005	Ma .....	D32/18
D456,960 S	5/2002	Vandenbelt et al.	D514,758 S	* 2/2006	Lau .....	D32/18
D459,560 S	6/2002	Lau	D515,258 S	* 2/2006	Robson .....	D32/18
6,434,785 B1	8/2002	Vandenbelt et al.				

\* cited by examiner

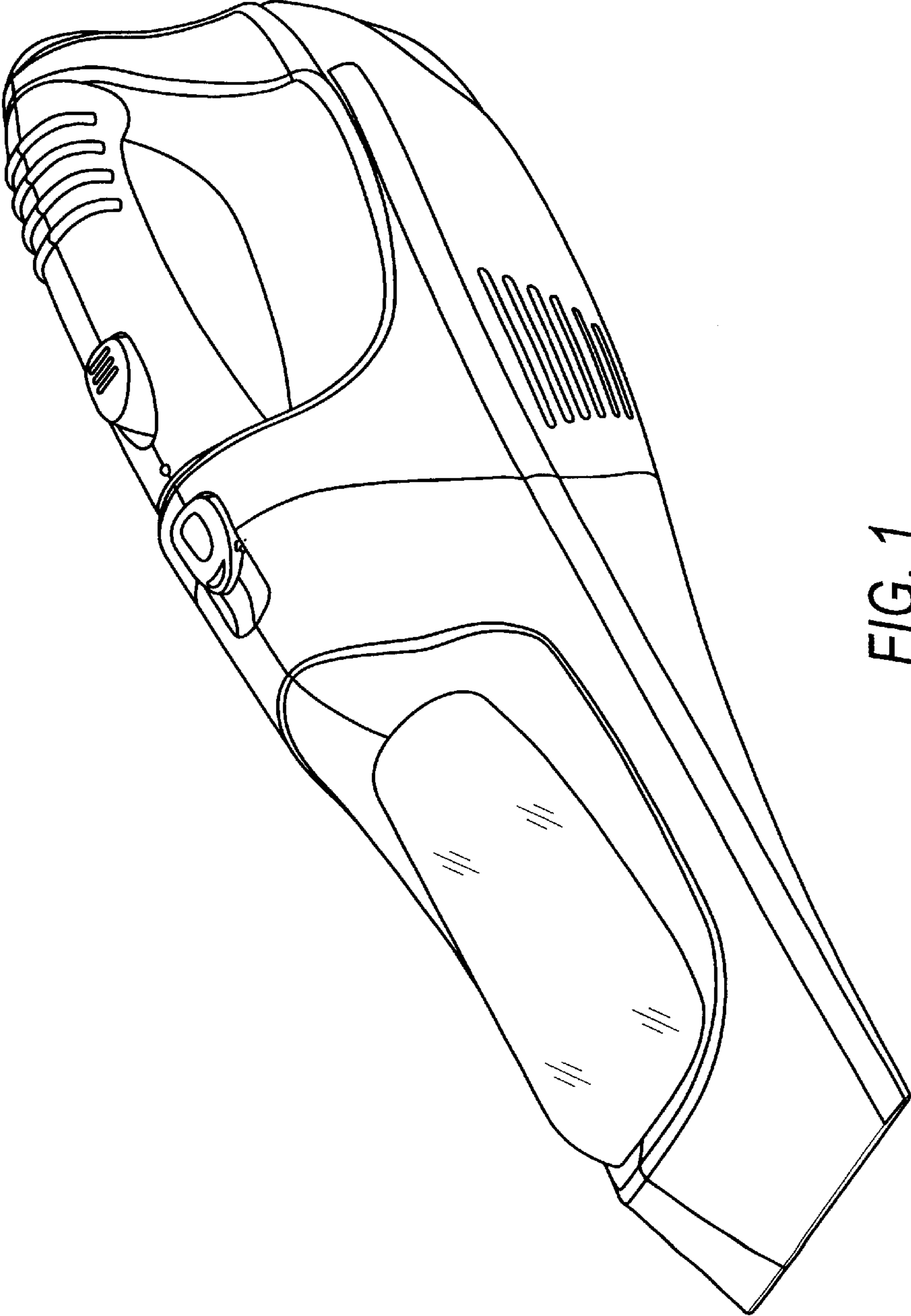

FIG. 1

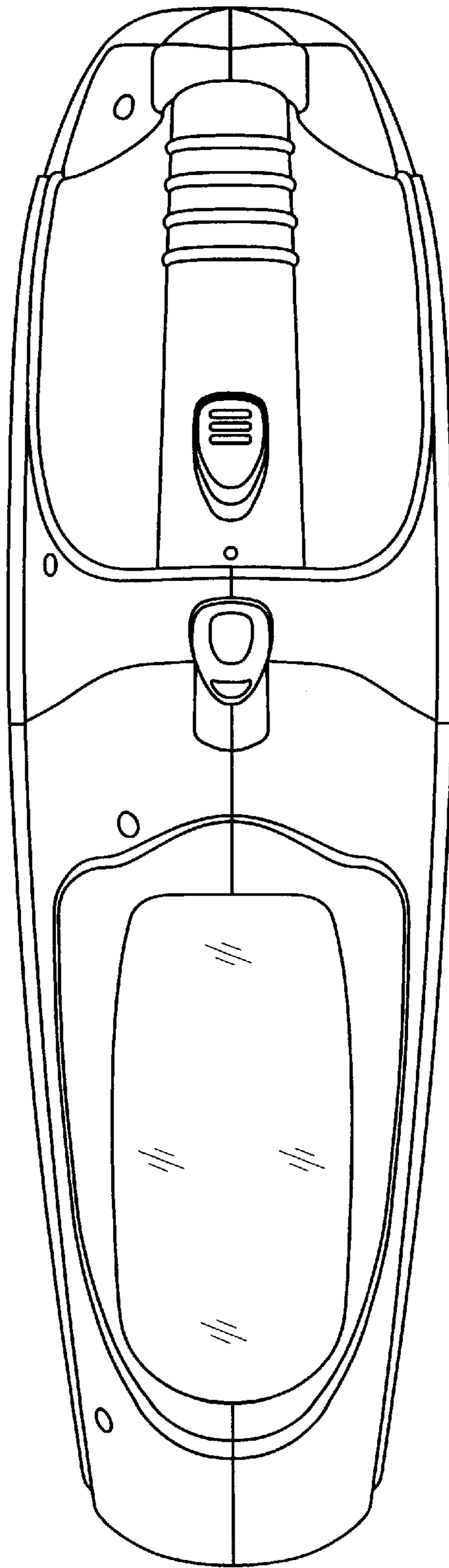

FIG. 2

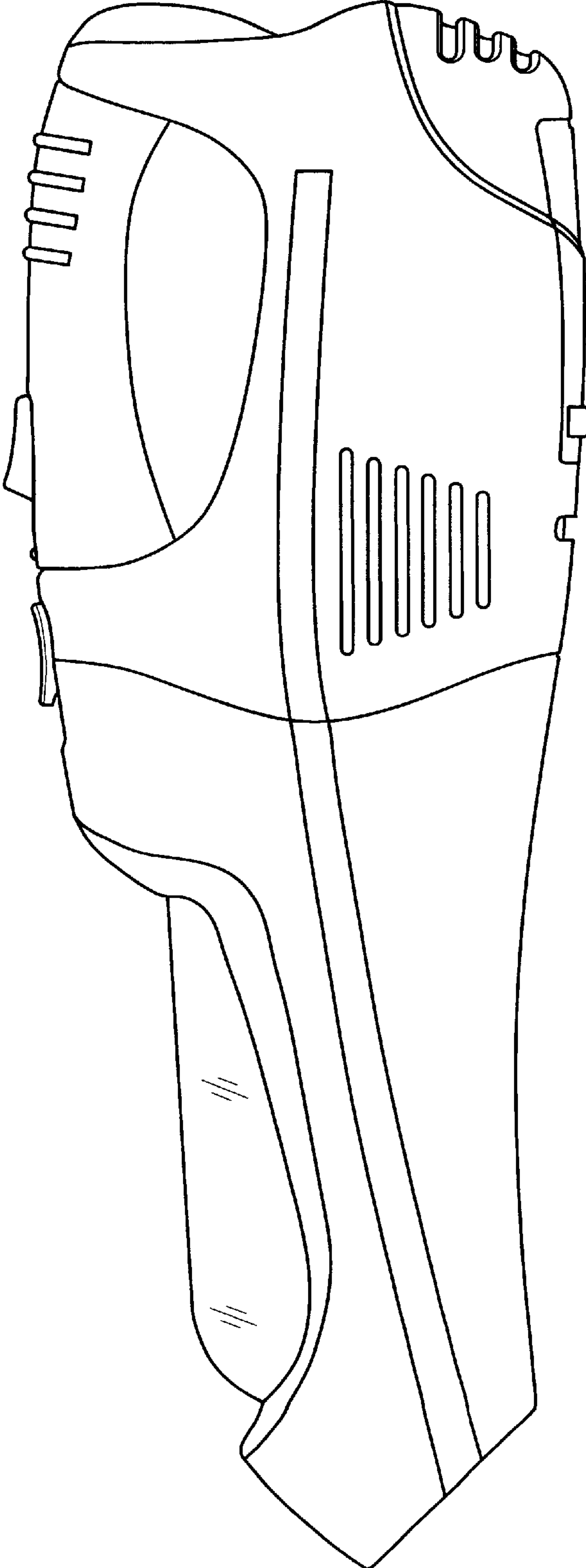

FIG. 3



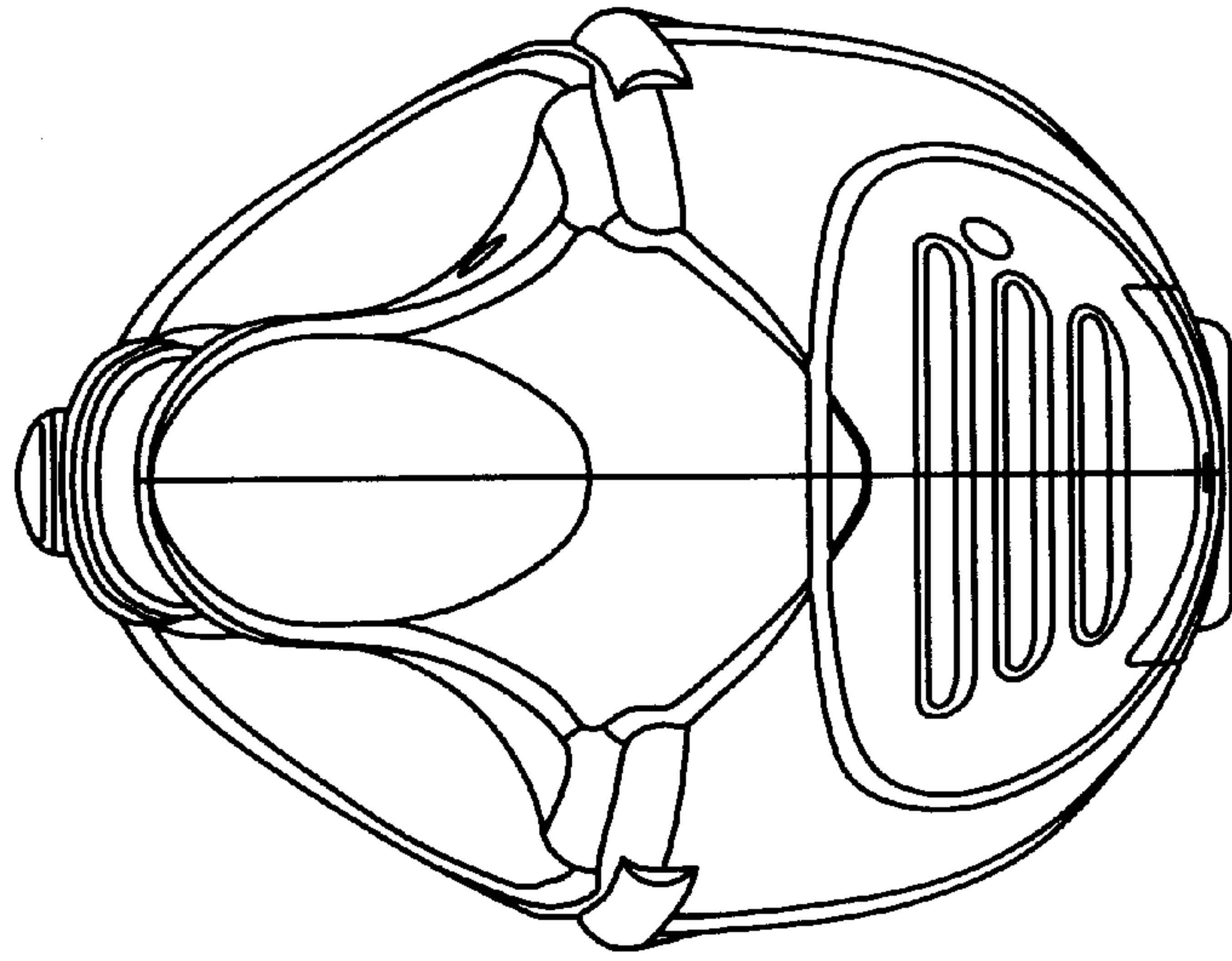

FIG. 5

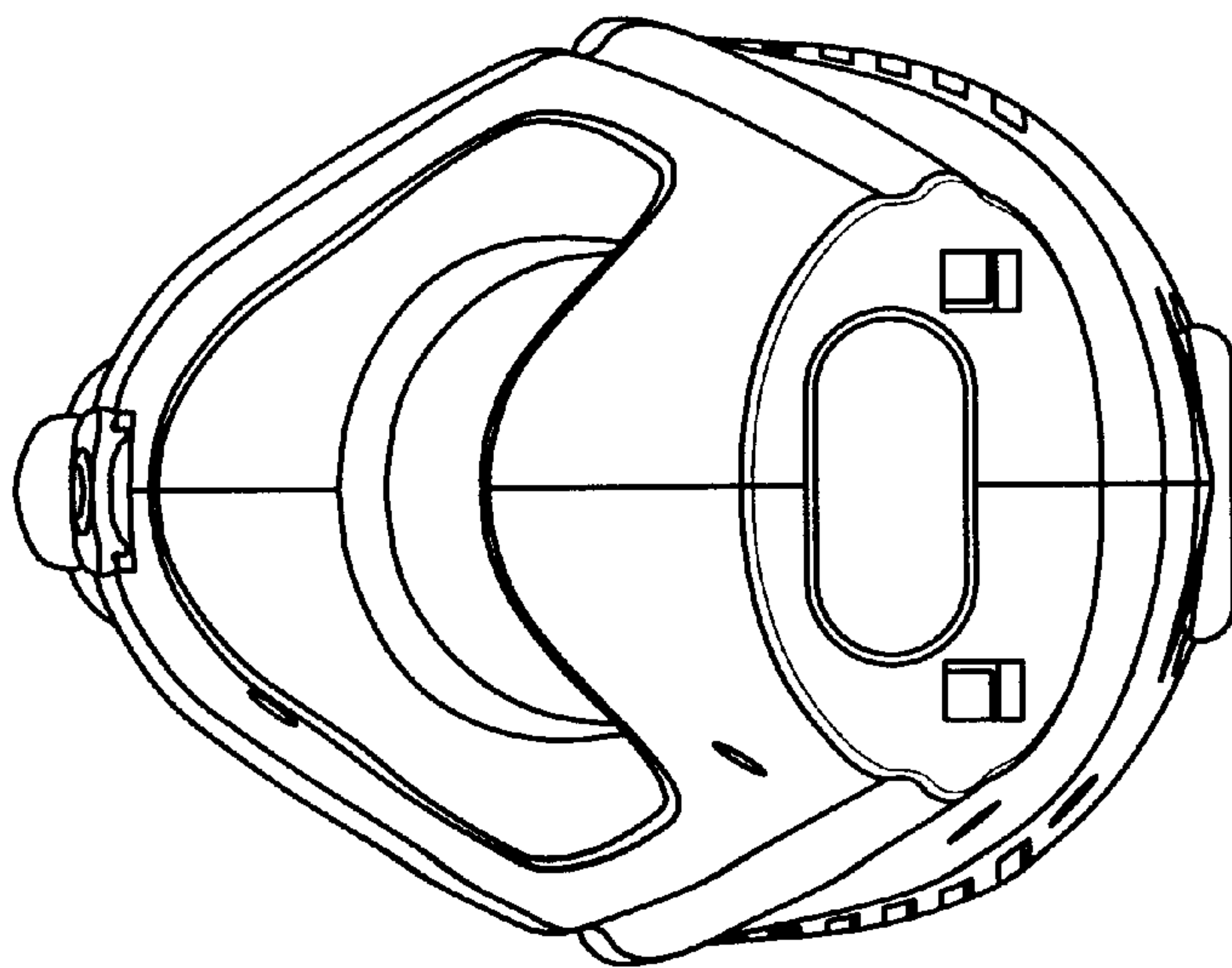

FIG. 4

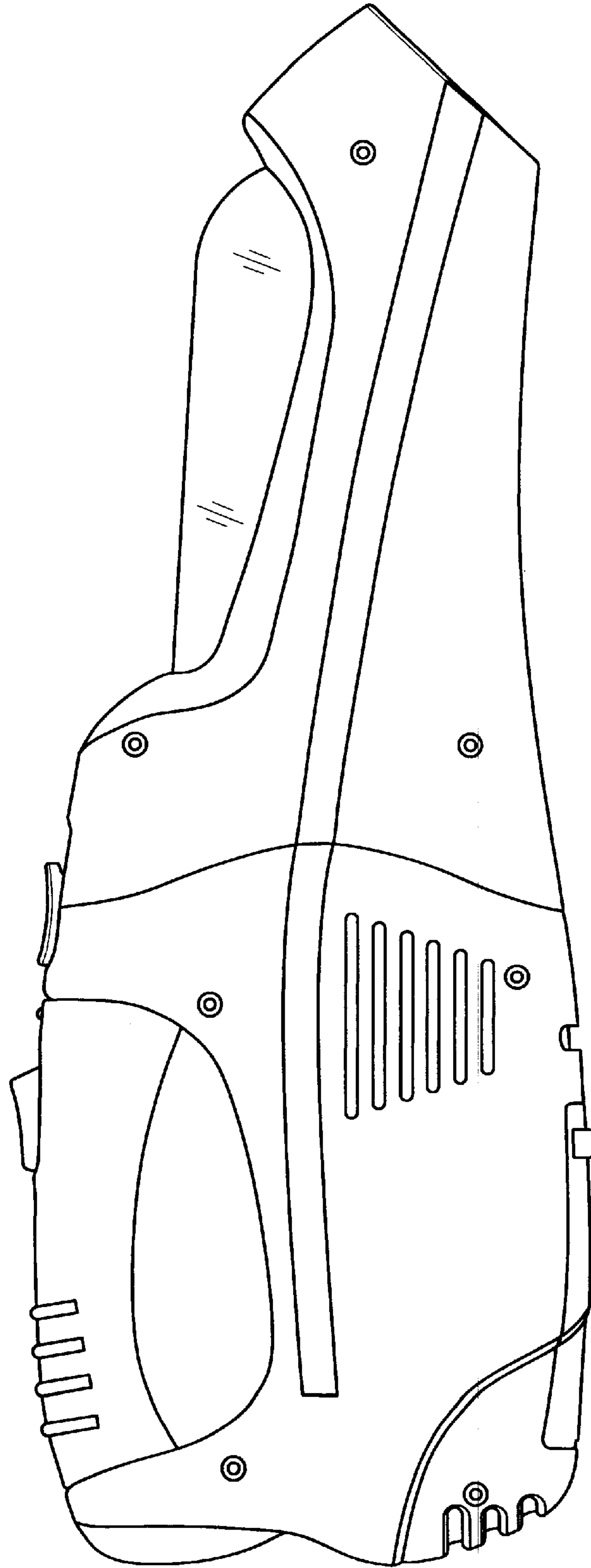

FIG. 6

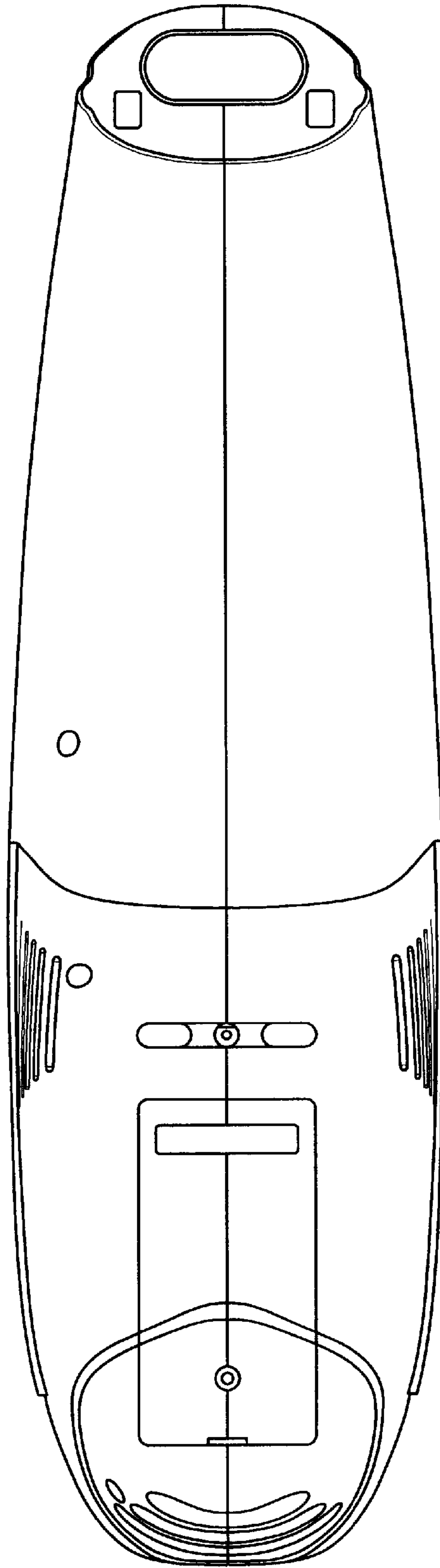

FIG. 7