



US00D527452S

(12) **United States Design Patent**
Hidalgo

(10) **Patent No.:** **US D527,452 S**

(45) **Date of Patent:** **** Aug. 29, 2006**

(54) **PORTION OF A CEILING FAN HOUSING**

(75) Inventor: **Rolando Hidalgo**, Orange, CA (US)

(73) Assignee: **Minka Lighting, Inc.**, Corona, CA (US)

(**) Term: **14 Years**

(21) Appl. No.: **29/214,263**

(22) Filed: **Sep. 30, 2004**

(51) **LOC (8) Cl.** **23-04**

(52) **U.S. Cl.** **D23/411**

(58) **Field of Classification Search** D23/377,
D23/379, 385, 411, 413; 416/5; D26/59,
D26/51, 72, 81-88; 362/96

See application file for complete search history.

(56) **References Cited**

U.S. PATENT DOCUMENTS

5,292,228 A *	3/1994	Dye	416/5
D410,100 S *	5/1999	Jaspers-Fayer	D26/59
D470,931 S *	2/2003	Hidalgo	D23/377
D504,502 S *	4/2005	Young	D23/377

OTHER PUBLICATIONS

The Art of Air Management—Minka Aire 2004; Minka Lighting, Inc., U.S.A.; Jan. 2004; p. 33.

Casablanca Internet Catalog; Bel Air Halo; Model No. 38H32; printed from www.celingfan.com; Aug. 30, 2004; 1 page.

Emerson Internet Catalog; Raphael; Model No. CF2600PW; printed from www.ceilingfan.com; Aug. 30, 2004; 1 page.

Hunter Internet Catalog; Charmaine; Model No. 28191; printed from www.ceilingfan.com; Aug. 30, 2004; 1 page. Minka-Lavery; Minka-Lavery 2005 Catalog; Jan. 2005; pp. 121-124; Minka Ligthing, Inc., U.S.A.

* cited by examiner

Primary Examiner—Lisa Lichtenstein

(74) *Attorney, Agent, or Firm*—Baker & McKenzie LLP

(57) **CLAIM**

The ornamental design for a portion of a ceiling fan housing, as shown and described.

DESCRIPTION

FIG. 1 is a perspective view from below of a portion of a ceiling fan housing in accordance with my design, including the environment thereof;

FIG. 2 is a greatly enlarged perspective view of the portion of a ceiling fan housing in accordance with my design, including the environment thereof;

FIG. 3 is a greatly enlarged perspective view of the portion of a ceiling fan housing in accordance with my design;

FIG. 4 is a greatly enlarged side elevation view of the portion of a ceiling fan housing in accordance with my design;

FIG. 5 is a greatly enlarged bottom plan view of the portion of a ceiling fan housing in accordance with my design; and,

FIG. 6 is a greatly enlarged top plan view of the portion of a ceiling fan housing in accordance with my design.

The broken lines showing environmental structure are for illustrative purposes and form no part of the claimed design.

1 Claim, 6 Drawing Sheets

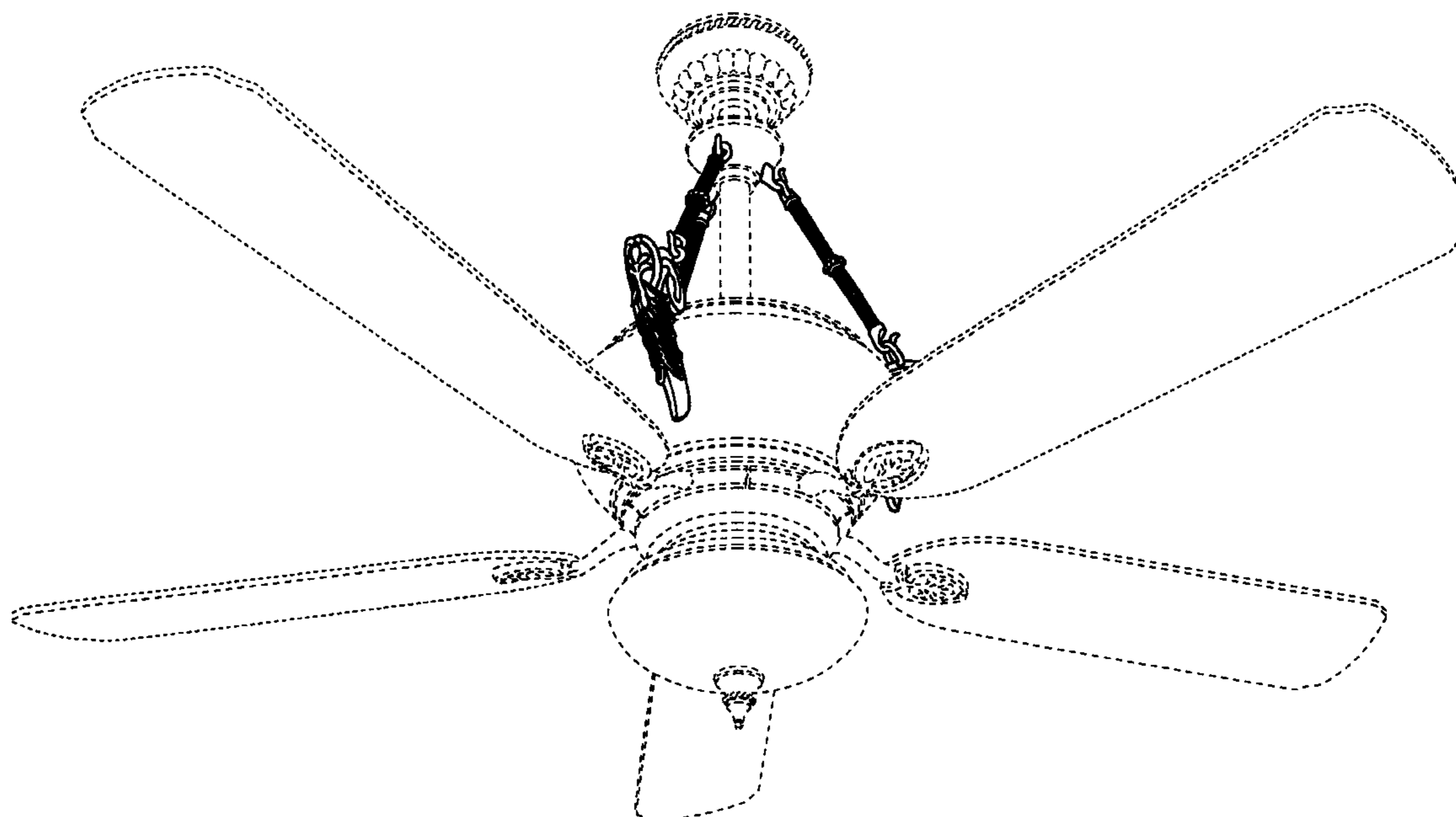

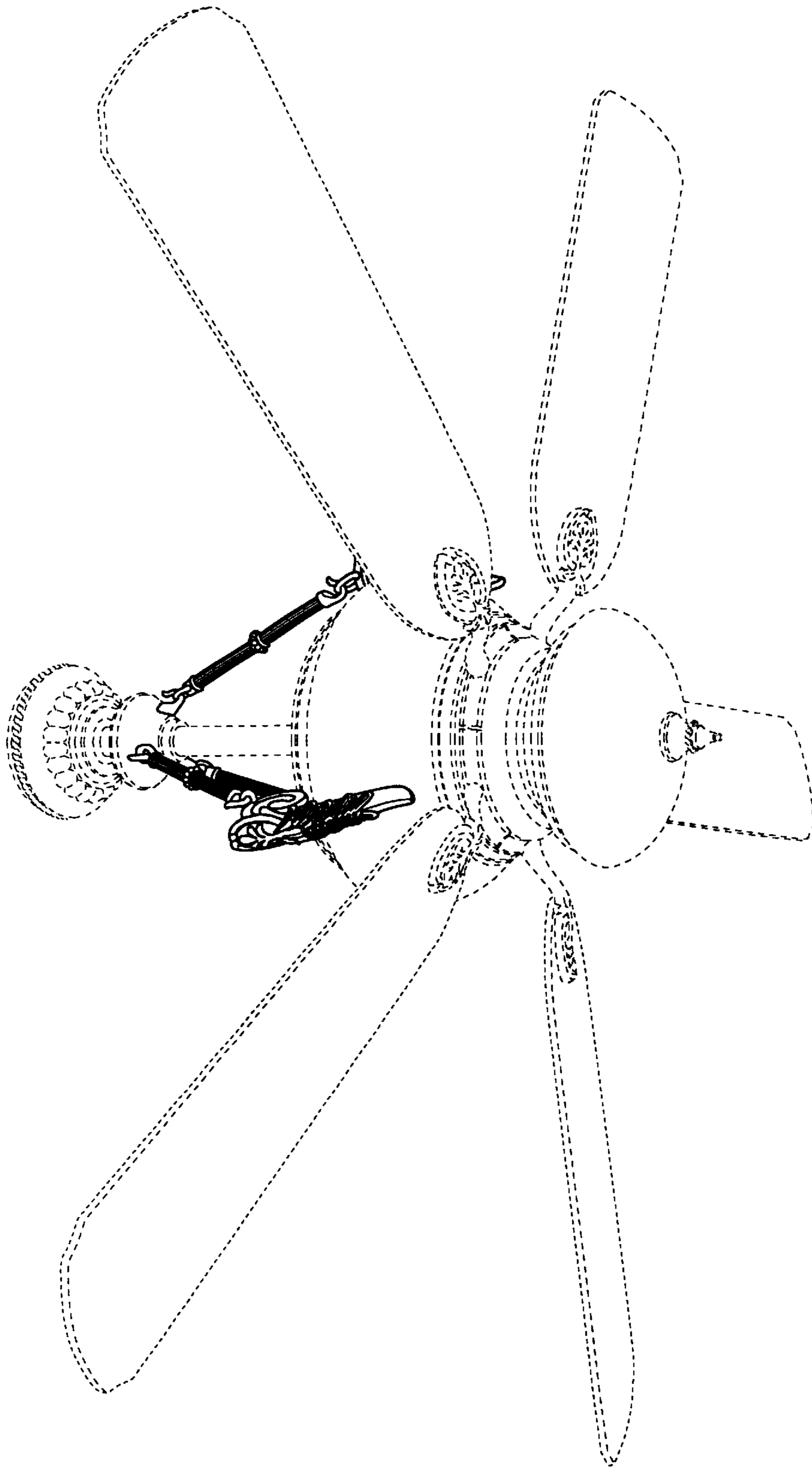

Fig.1

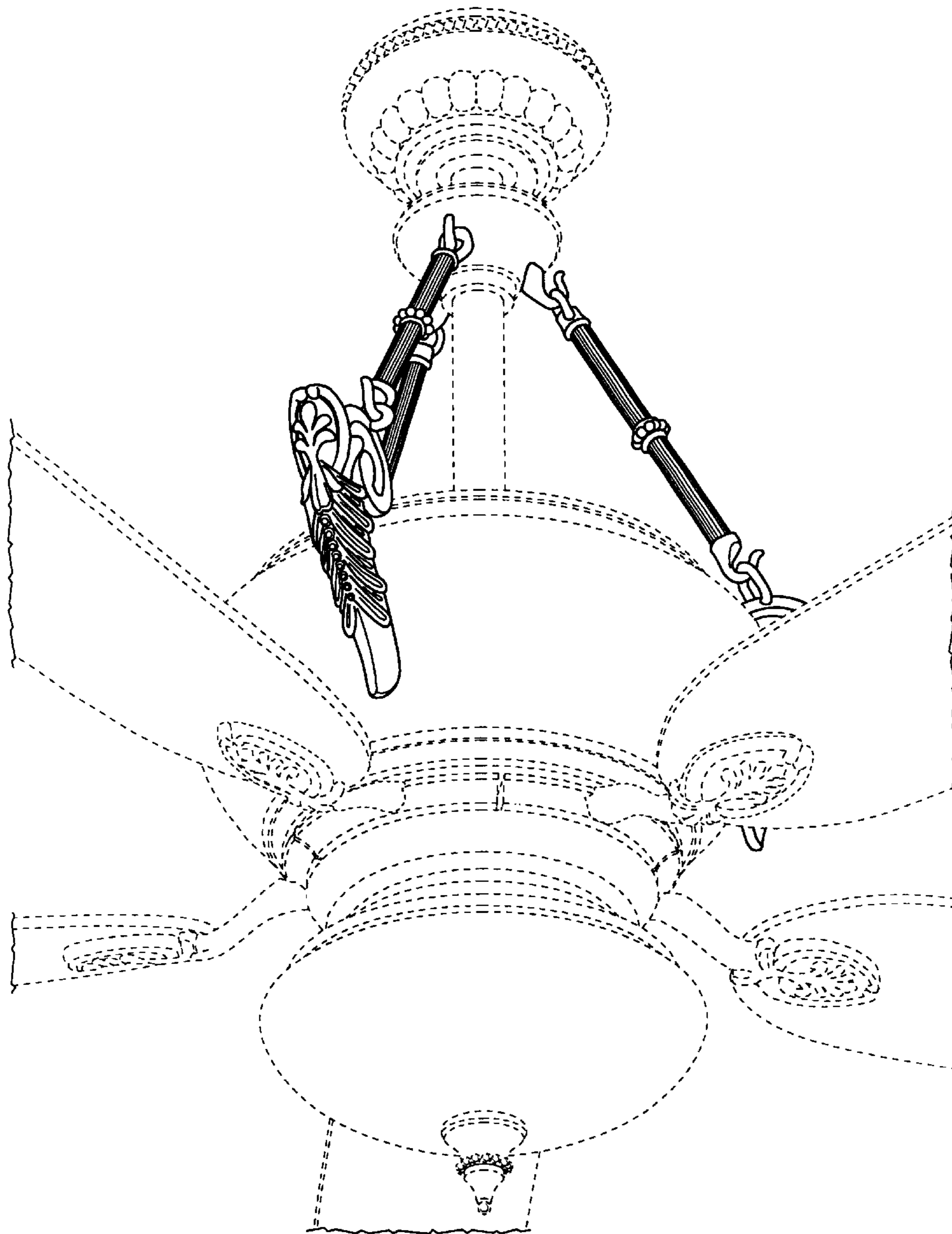

Fig.2

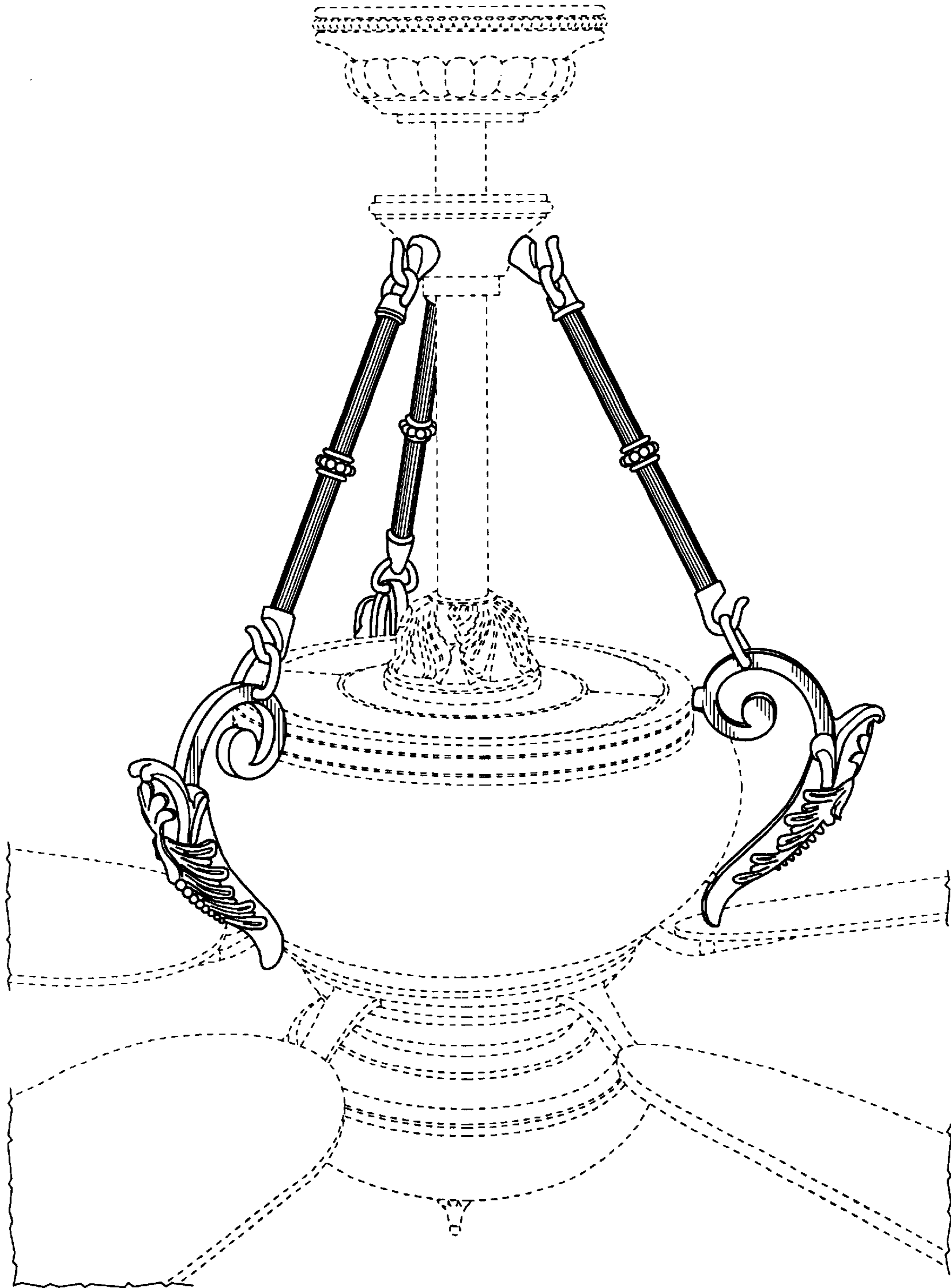

Fig.3

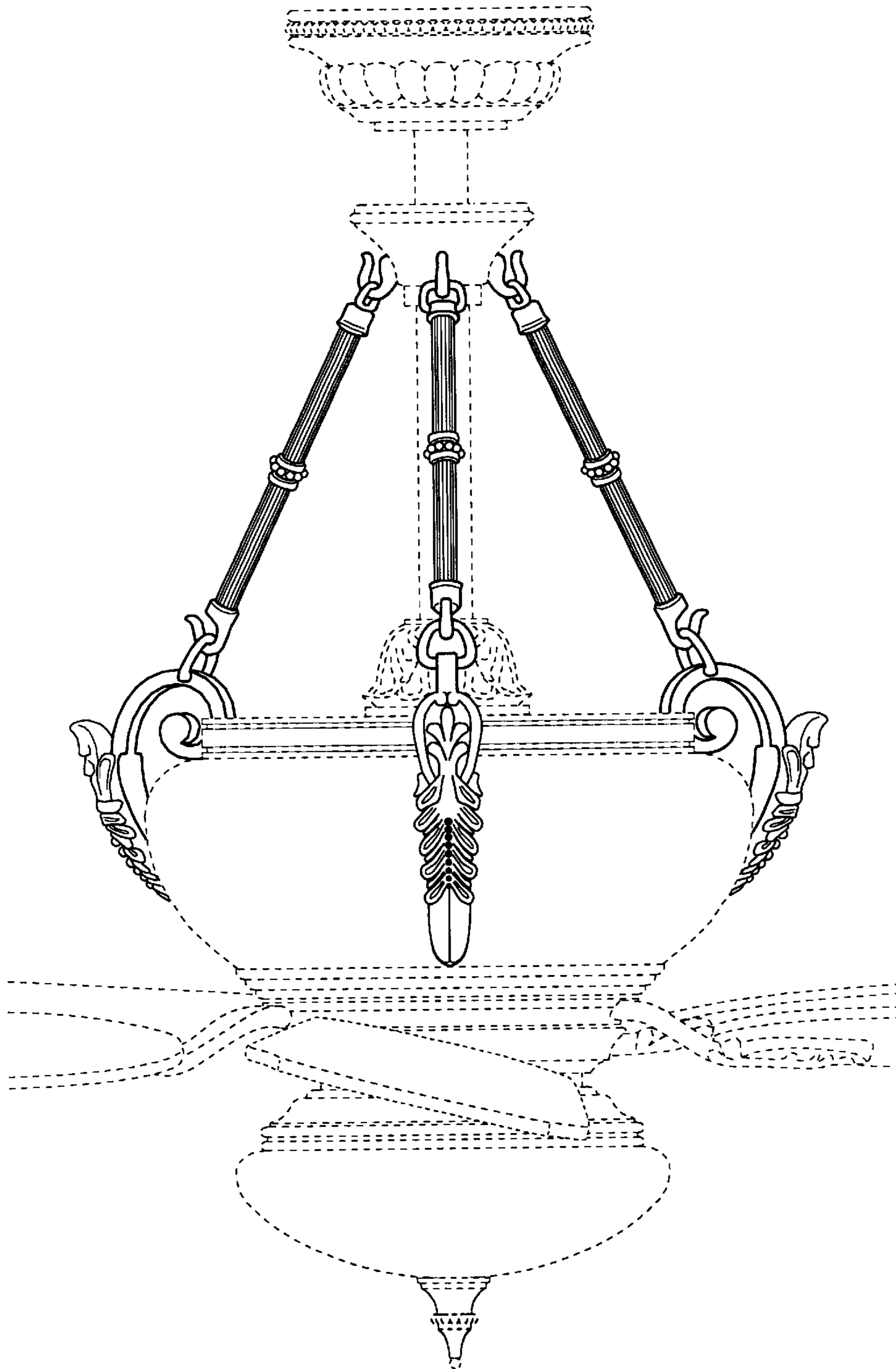

Fig.4

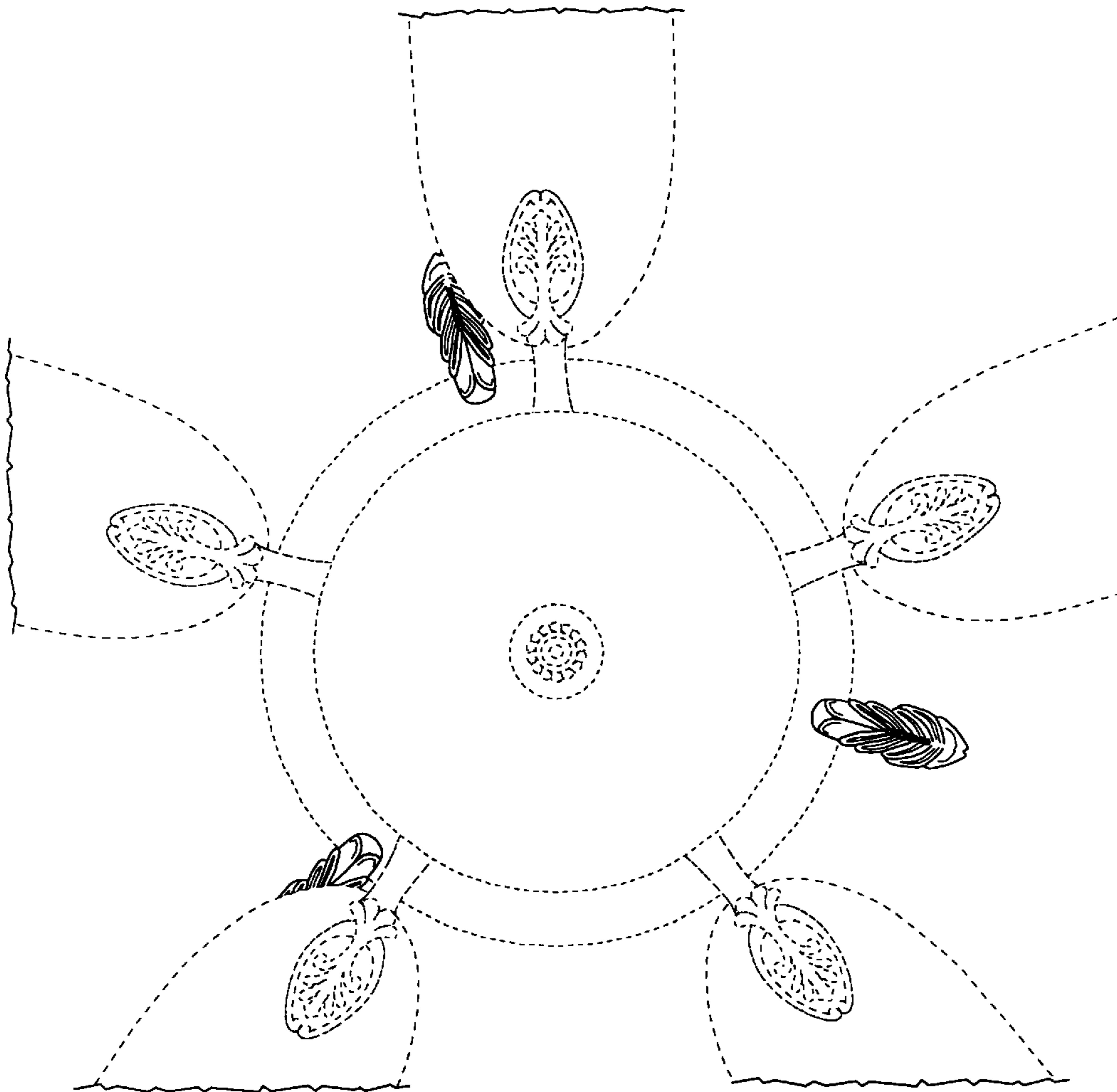

Fig.5

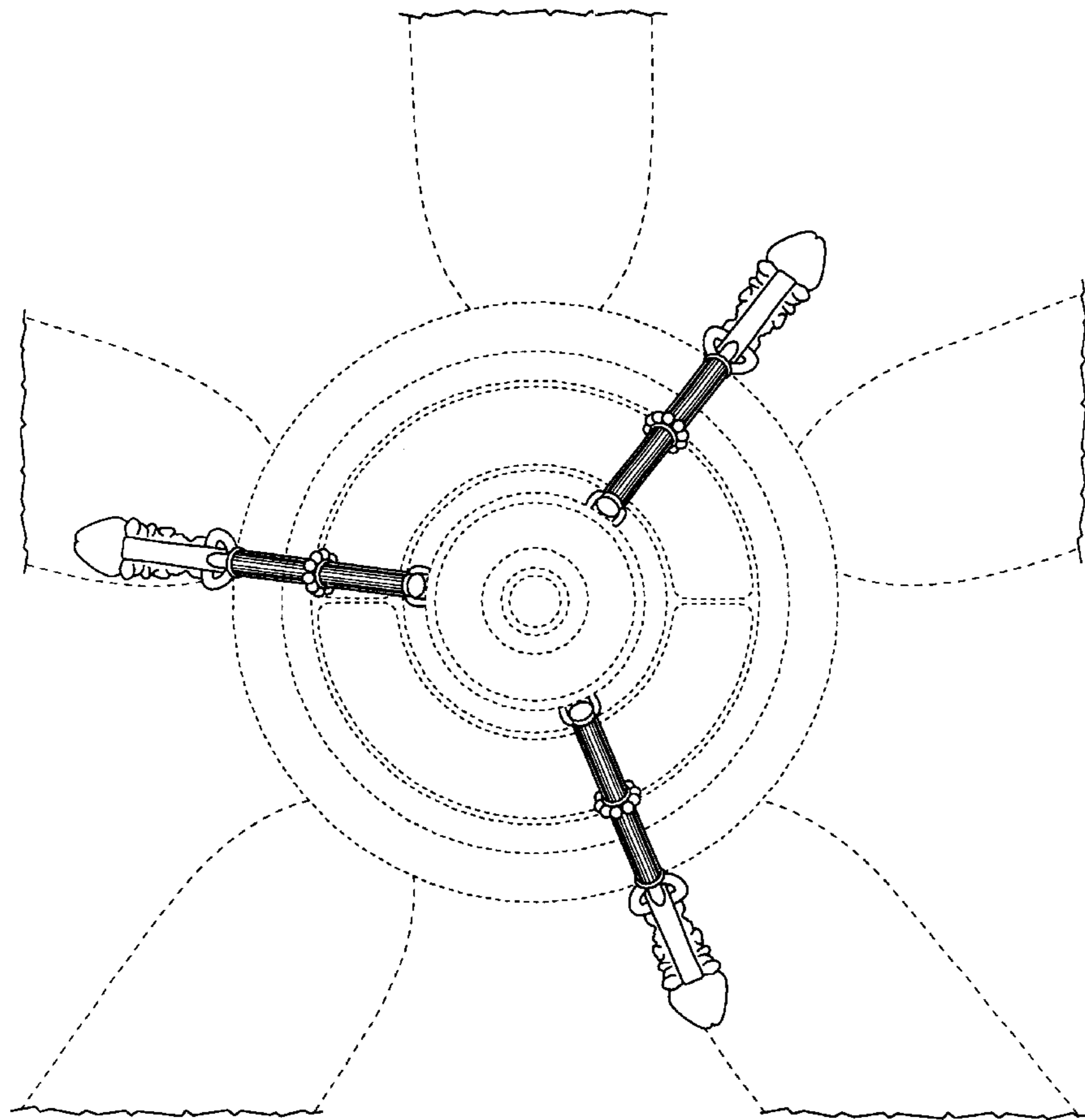

Fig.6