

US00D527419S

(12) **United States Design Patent**  
**Anbiru et al.**

(10) **Patent No.:** **US D527,419 S**

(45) **Date of Patent:** **\*\* Aug. 29, 2006**

(54) **TAPE CARTRIDGE FOR A TAPE WRITING DEVICE**

(75) Inventors: **Yasuhide Anbiru**, Tokyo (JP); **Yuichiro Taniguchi**, Tokyo (JP)

(73) Assignee: **King Jim Co., Ltd.**, Tokyo (JP)

(\*\*) Term: **14 Years**

(21) Appl. No.: **29/229,040**

(22) Filed: **May 2, 2005**

(30) **Foreign Application Priority Data**

Nov. 18, 2004 (JP) ..... 2004-035223

(51) **LOC (8) Cl.** ..... **18-02**

(52) **U.S. Cl.** ..... **D18/56**

(58) **Field of Classification Search** ..... D18/12,  
D18/18, 40, 43, 56; D14/435, 471, 481, 483,  
D14/484; 347/178, 214; 400/207-208, 208.1,  
400/193-196, 196.1, 234-235, 235.1, 240.4,  
400/242, 613; 399/110

See application file for complete search history.

(56) **References Cited**

**U.S. PATENT DOCUMENTS**

D245,116 S	*	7/1977	Trezise	.....	D18/12
D267,566 S	*	1/1983	Hoffman	.....	D18/12
D277,999 S	*	3/1985	Weiner	.....	D18/12
D290,135 S	*	6/1987	Minakuchi et al.	.....	D18/12
D307,437 S	*	4/1990	Costa	.....	D18/12
D313,612 S	*	1/1991	Rossopoulos	.....	D18/12
D347,241 S	*	5/1994	Watanabe et al.	.....	D18/56
D355,671 S	*	2/1995	Onumata	.....	D18/56
D358,165 S	*	5/1995	Ehara	.....	D18/56
D372,044 S	*	7/1996	Ware et al.	.....	D18/56

5,620,268 A	*	4/1997	Yamaguchi et al.	.....	400/207
5,653,542 A	*	8/1997	Sugimoto et al.	.....	400/207
6,019,528 A	*	2/2000	Martinez et al.	.....	400/208
D435,589 S	*	12/2000	Huss	.....	D18/56
6,520,696 B1	*	2/2003	Huss et al.	.....	400/208
6,955,318 B1	*	10/2005	Nonomura	.....	242/344

**OTHER PUBLICATIONS**

U.S. Appl. No. 29/229,041 filed May 2, 2005; K. Sakuma, et al; Tape Writing Device.

\* cited by examiner

*Primary Examiner*—Cathy Anne MacCormac

(74) *Attorney, Agent, or Firm*—Frishauf, Holtz, Goodman & Chick, P.C.

(57) **CLAIM**

The ornamental design for a tape cartridge for a tape writing device, as shown and described.

**DESCRIPTION**

FIG. 1 is a front, top and right side perspective view of a tape cartridge for a tape writing device;

FIG. 2 is a front view thereof;

FIG. 3 is a rear view thereof;

FIG. 4 is a top plan view thereof;

FIG. 5 is a bottom plan view thereof;

FIG. 6 is a left side view thereof; and,

FIG. 7 is a right side view thereof.

The broken line showing in the drawings is for illustrative purposes only and forms no part of the claimed design. The single-dot chain lines indicate the boundaries that separate the portions being claimed and the portions that are shown for illustrative purposes only.

**1 Claim, 2 Drawing Sheets**

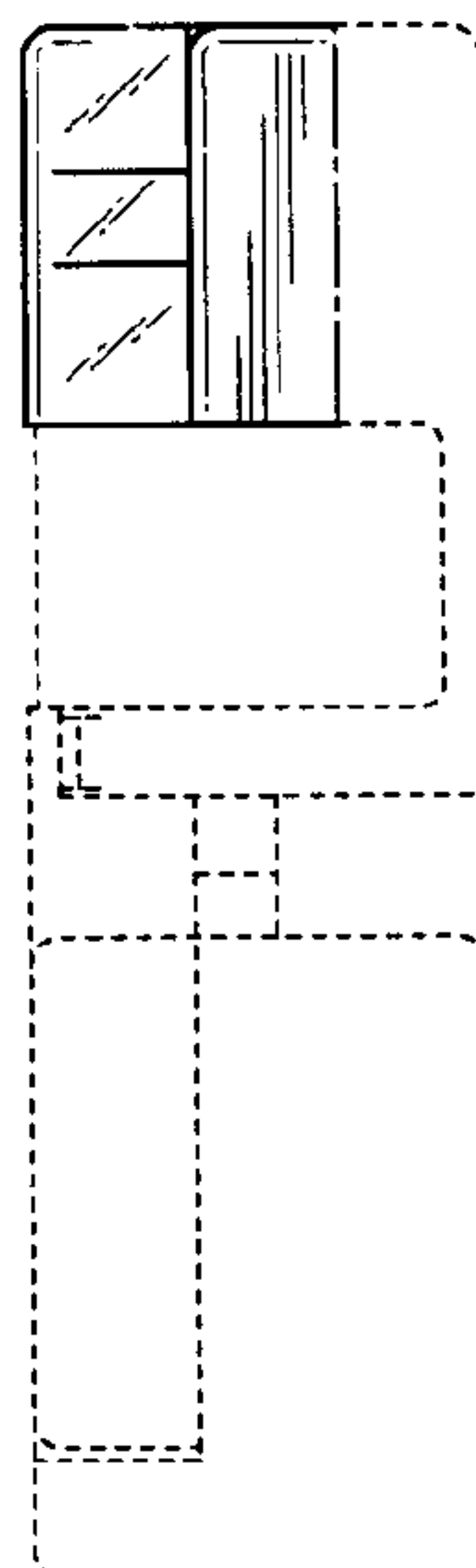

Fig. 1

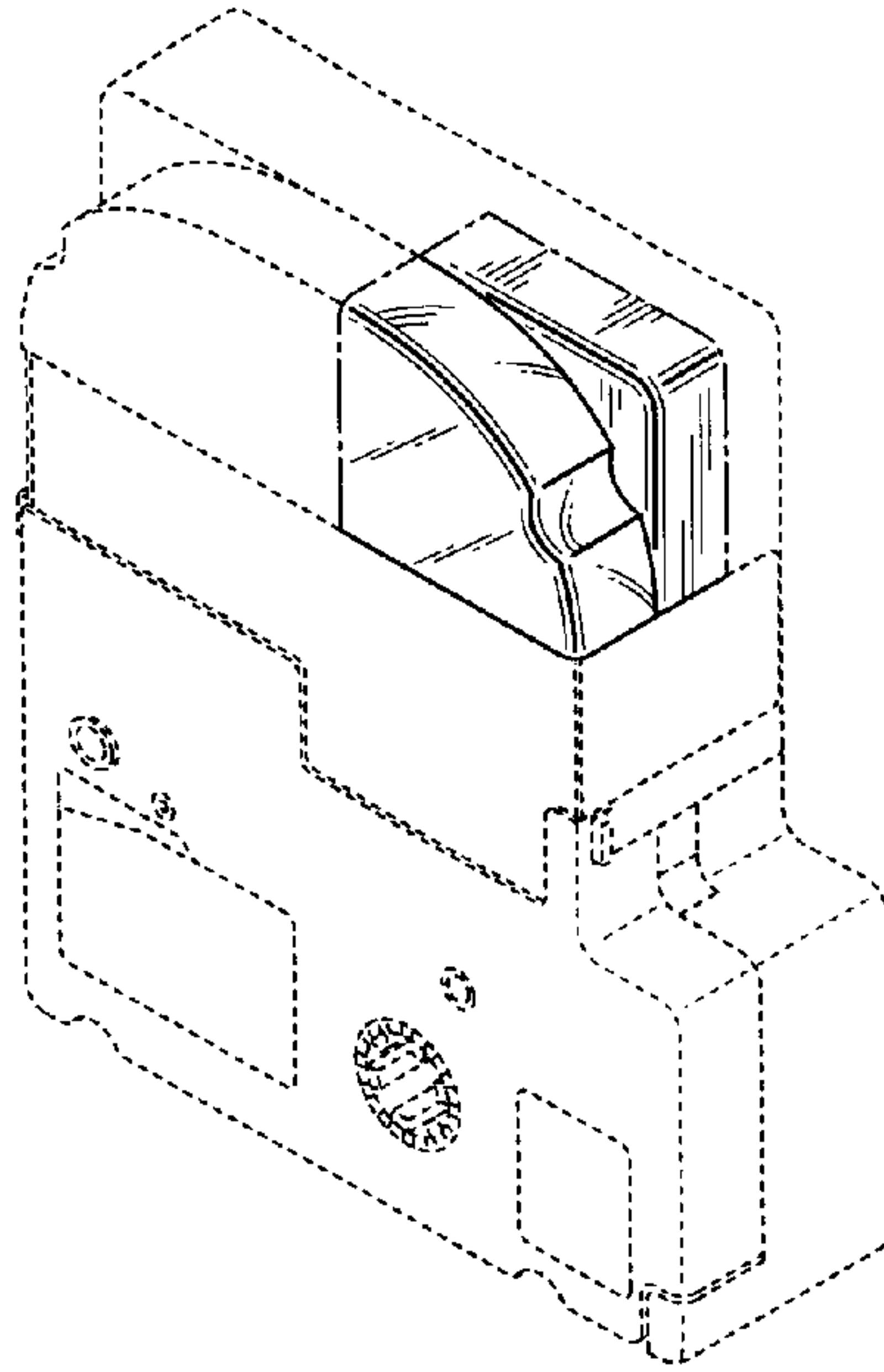

Fig. 2

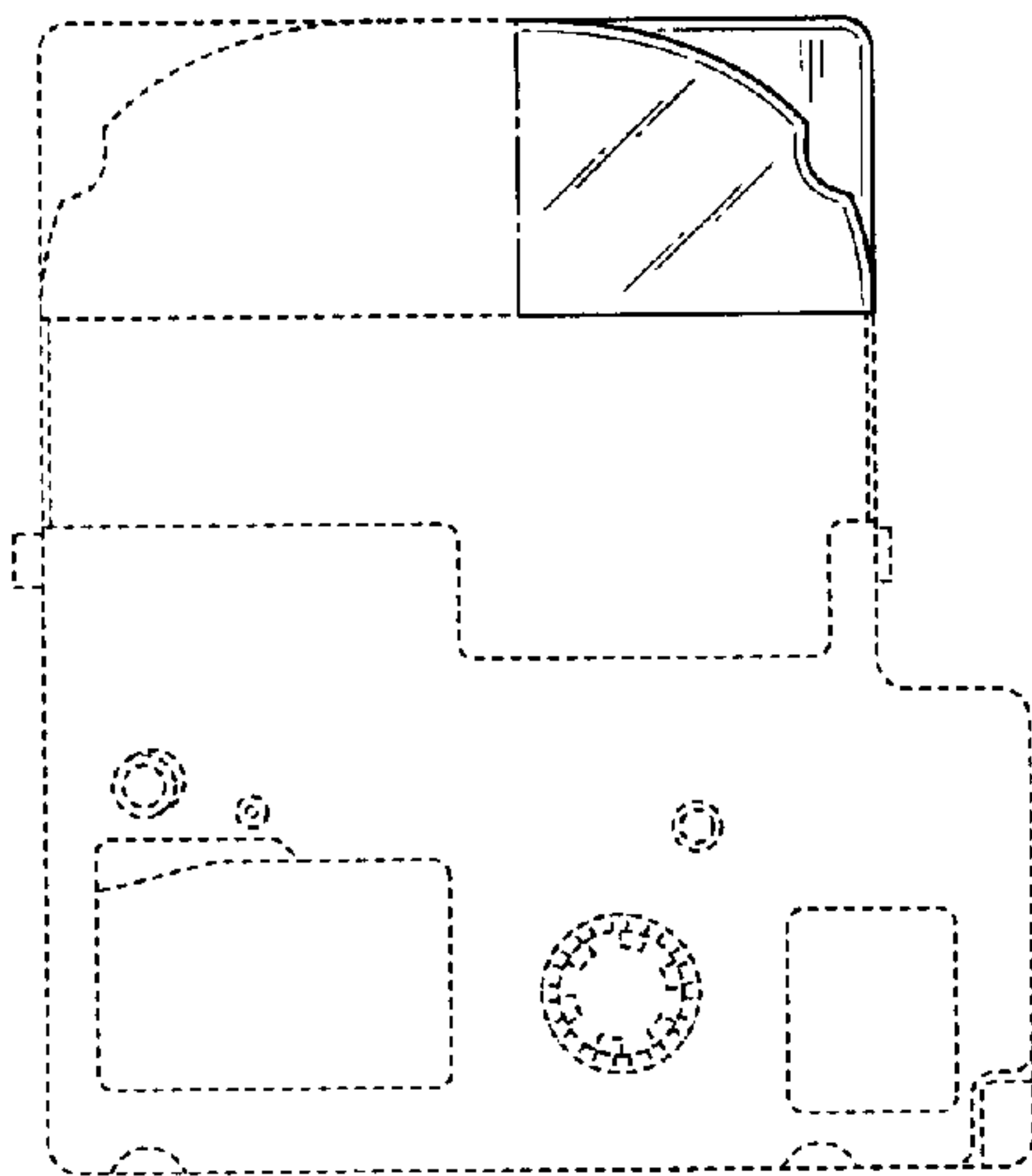

Fig. 3

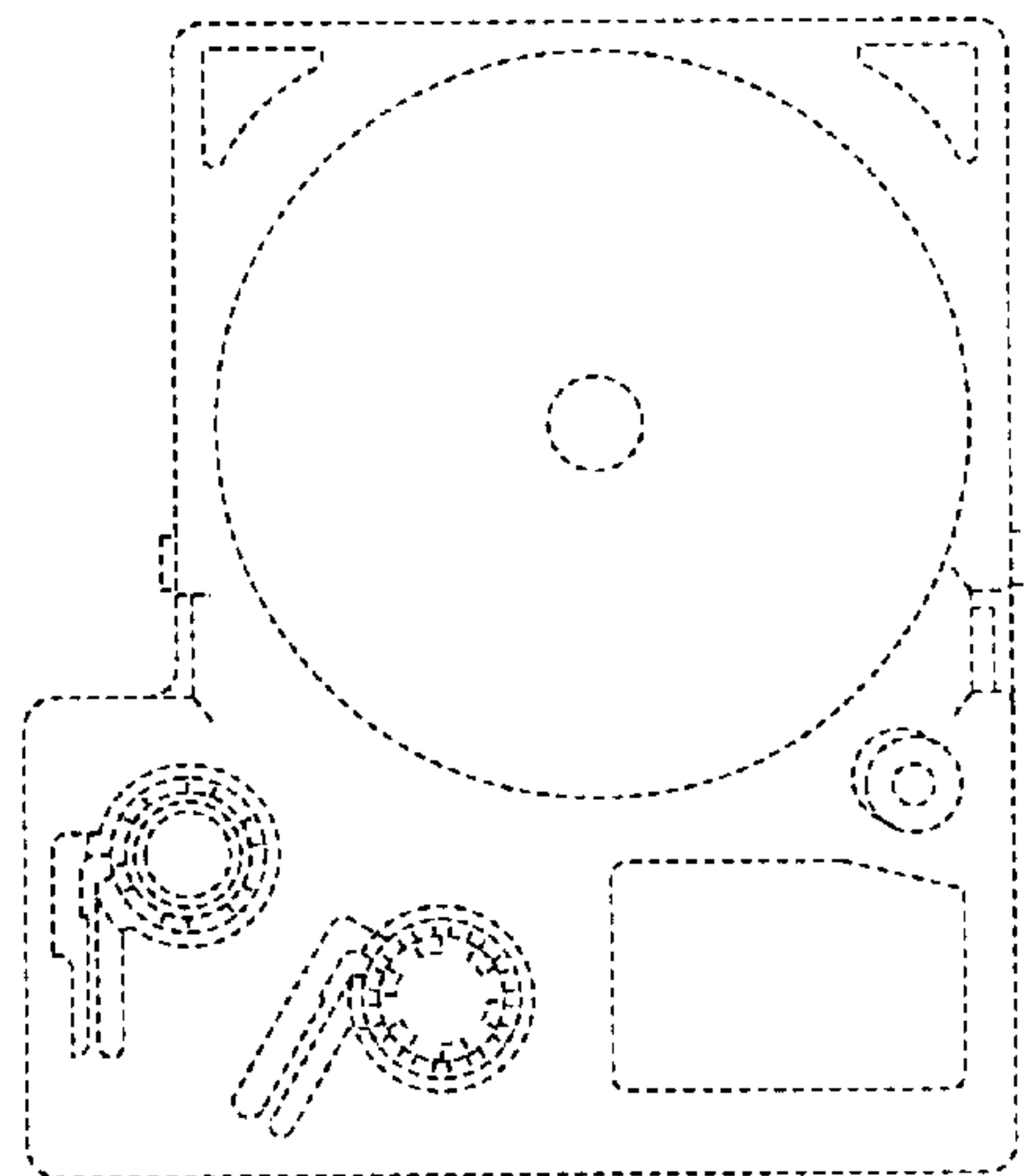

Fig. 4

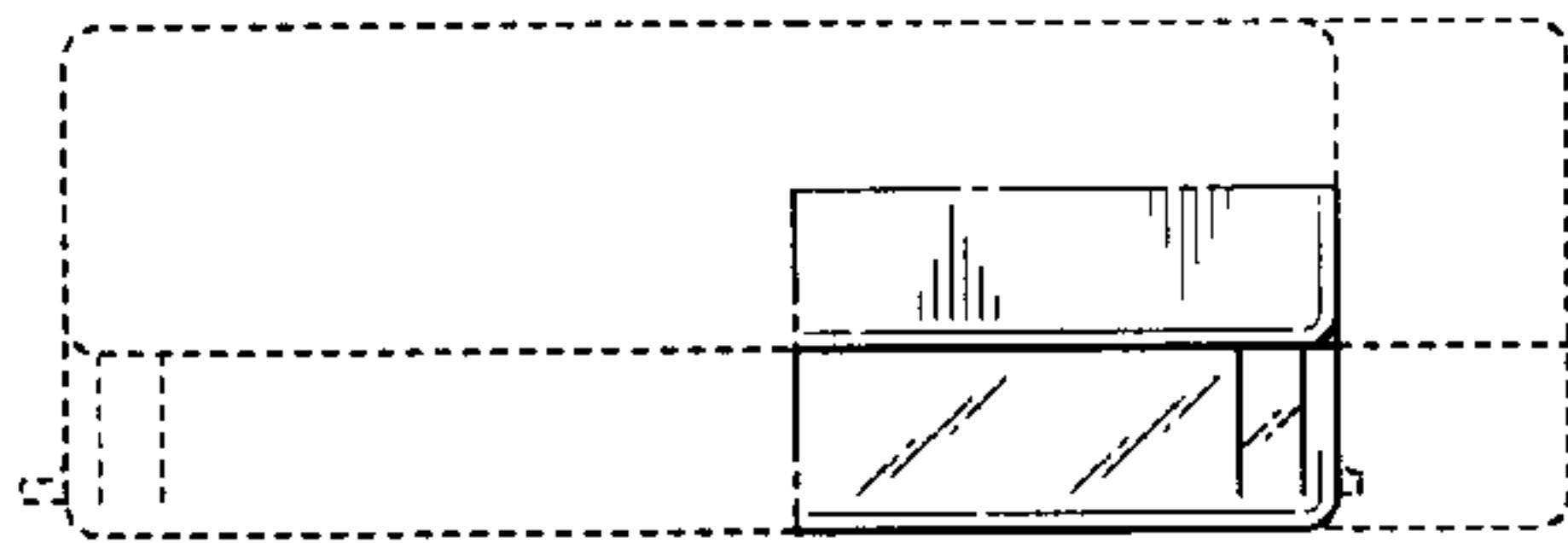

Fig. 5

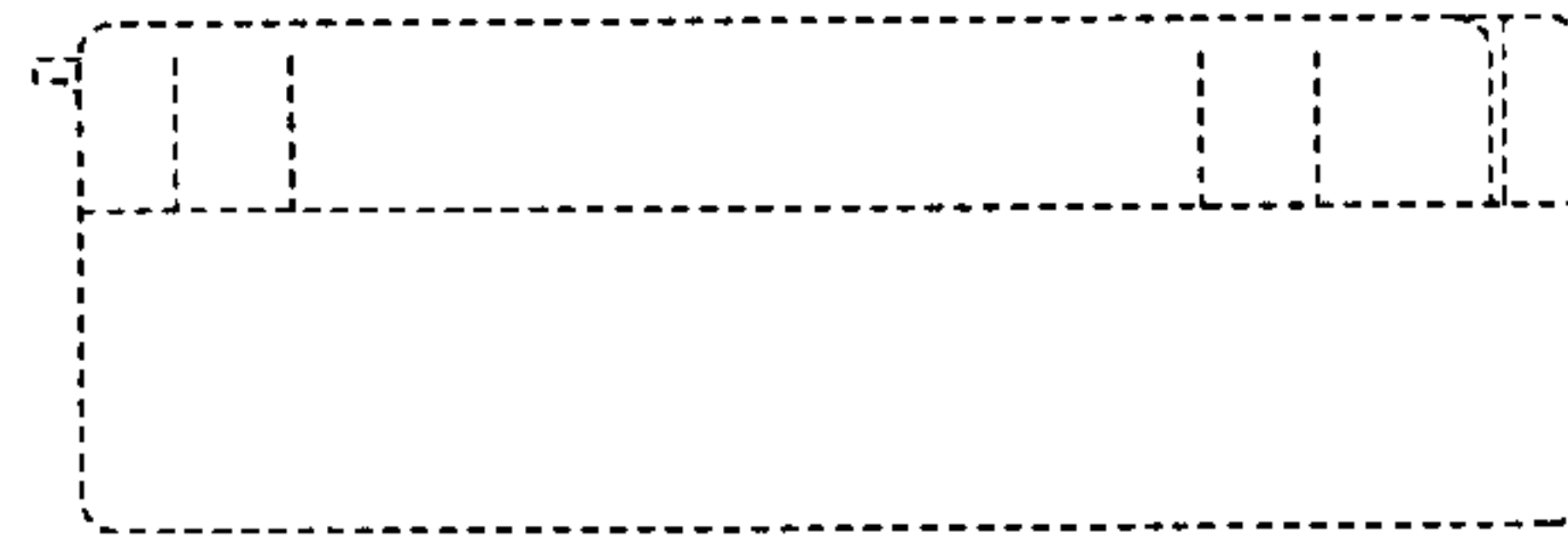

Fig. 6

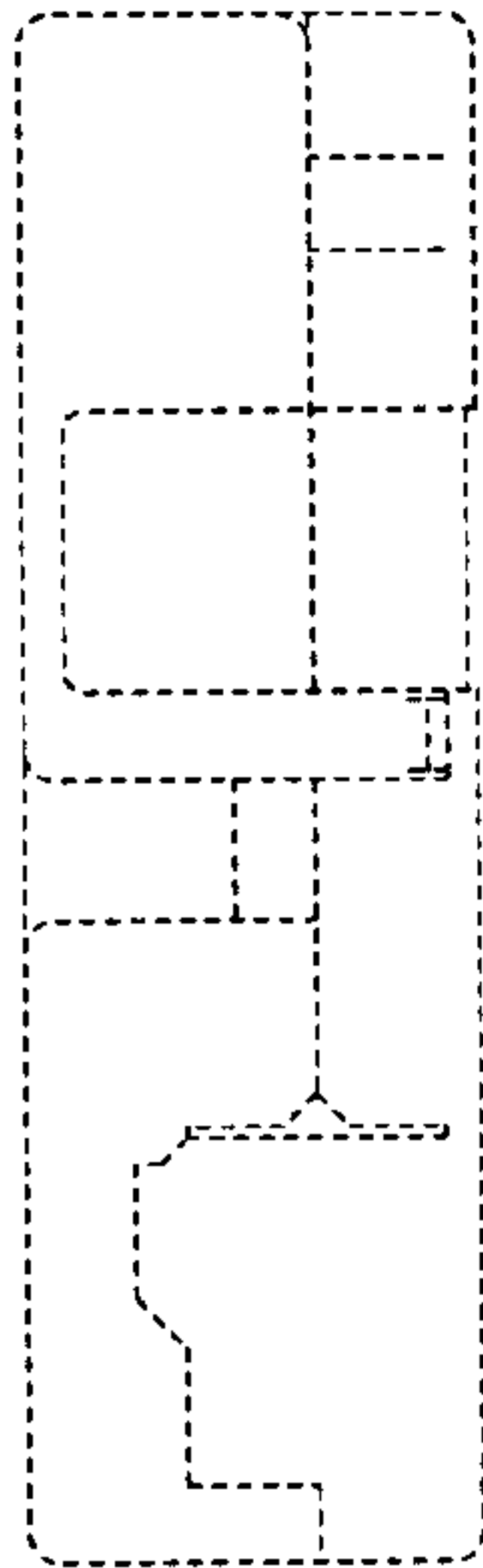

Fig. 7

