



US00D527385S

(12) **United States Design Patent**
Liu et al.

(10) **Patent No.:** **US D527,385 S**

(45) **Date of Patent:** **** Aug. 29, 2006**

(54) **FRONT BEZEL FOR COMPUTER ENCLOSURE**

D431,825 S * 10/2000 Jean et al. D14/444
D438,517 S * 3/2001 Chen et al. D14/444
D459,357 S * 6/2002 Lo D14/444

(75) Inventors: **Yuan-Yuan Liu**, Shenzhen (CN);
Yun-Dong Xu, Shenzhen (CN)

* cited by examiner

(73) Assignee: **Hon Hai Precision Industry Co., Ltd.**,
Taipei (TW)

Primary Examiner—Freda S. Nunn

(74) *Attorney, Agent, or Firm*—Jeffrey T. Knapp

(**) Term: **14 Years**

(57) **CLAIM**

(21) Appl. No.: **29/239,103**

The ornamental design for a front bezel for computer enclosure, as shown and described.

(22) Filed: **Sep. 26, 2005**

DESCRIPTION

(30) **Foreign Application Priority Data**

Jun. 10, 2005 (CN) 2005 3 0061444

FIG. 1 is a perspective view of a front bezel being mounted to a computer enclosure showing our new design;

(51) **LOC (8) Cl.** **14-02**

FIG. 2 is a front elevational view thereof;

(52) **U.S. Cl.** **D14/444**

FIG. 3 is a left side elevational view thereof;

(58) **Field of Classification Search** D14/441-446;
D13/162, 184, 199; 312/223.2; 360/99.01-99.12;
361/680-686, 690-696; 369/34.01, 36.01

FIG. 4 is a right side elevational view thereof;

See application file for complete search history.

FIG. 5 is a top plan view thereof; and,

FIG. 6 is a bottom plan view thereof.

Broken lines are for illustrative purposes only and form no part of the claimed design.

(56) **References Cited**

U.S. PATENT DOCUMENTS

5,169,218 A * 12/1992 Chu 312/223.2

1 Claim, 6 Drawing Sheets

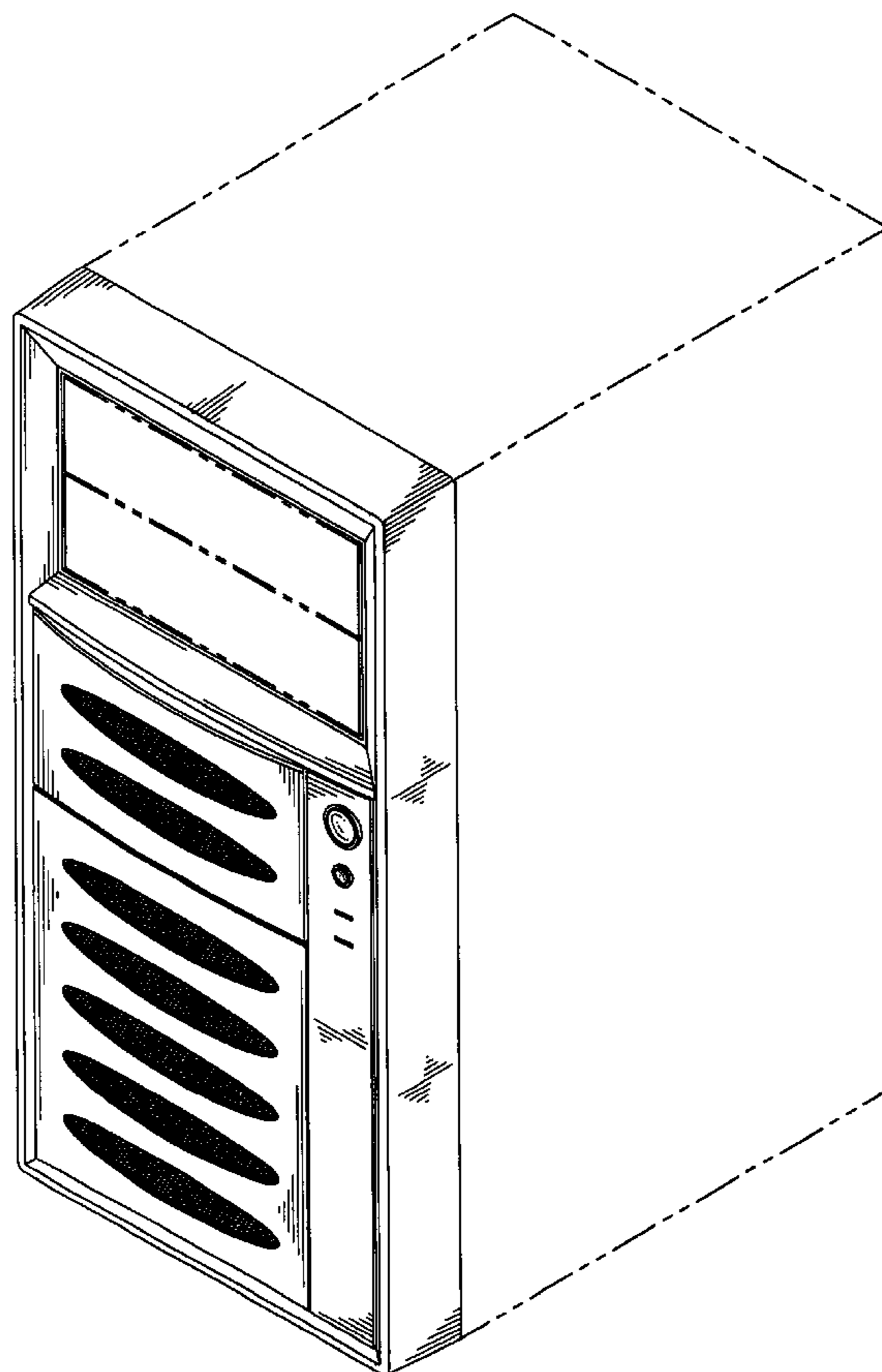

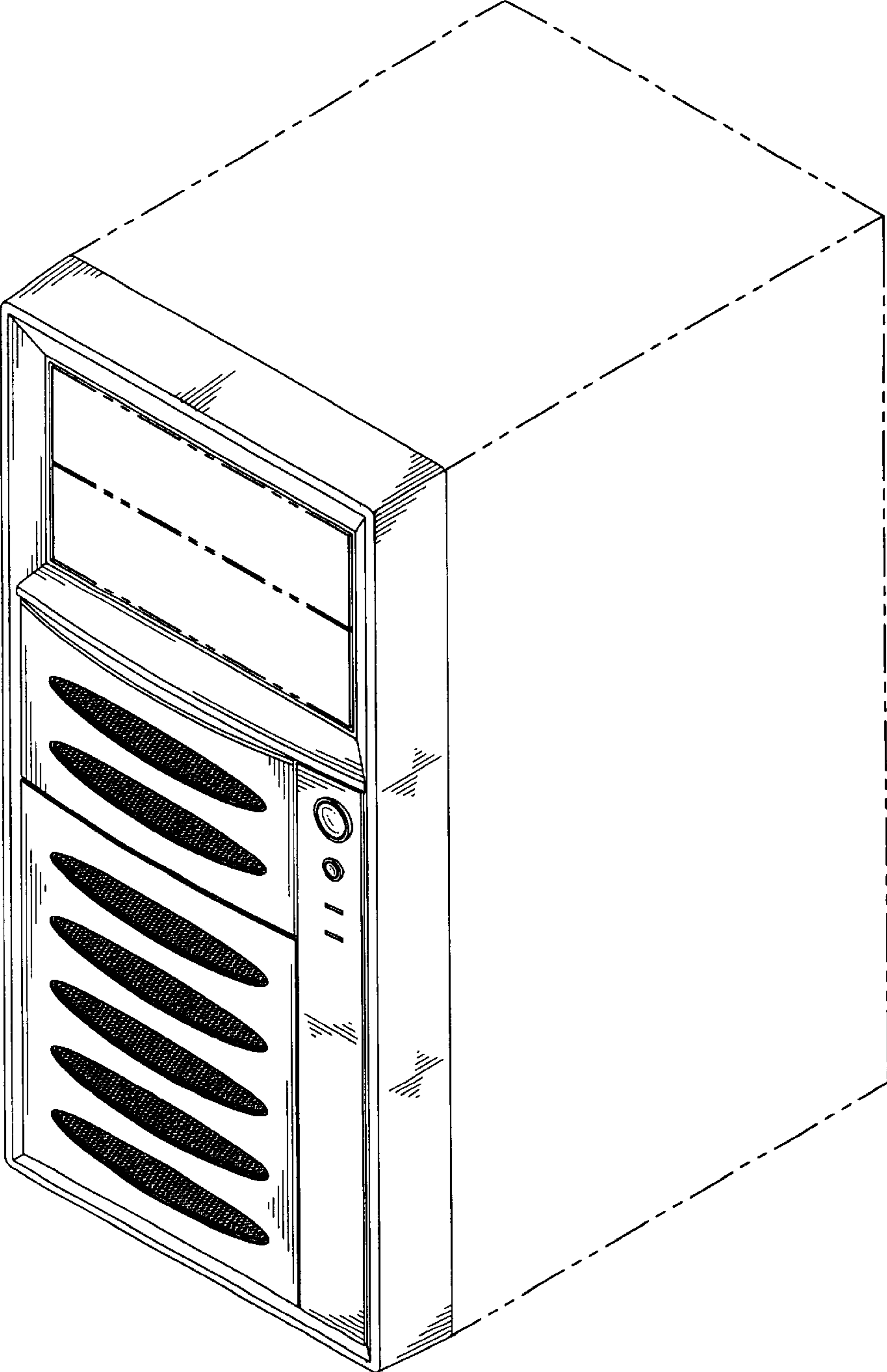

FIG. 1

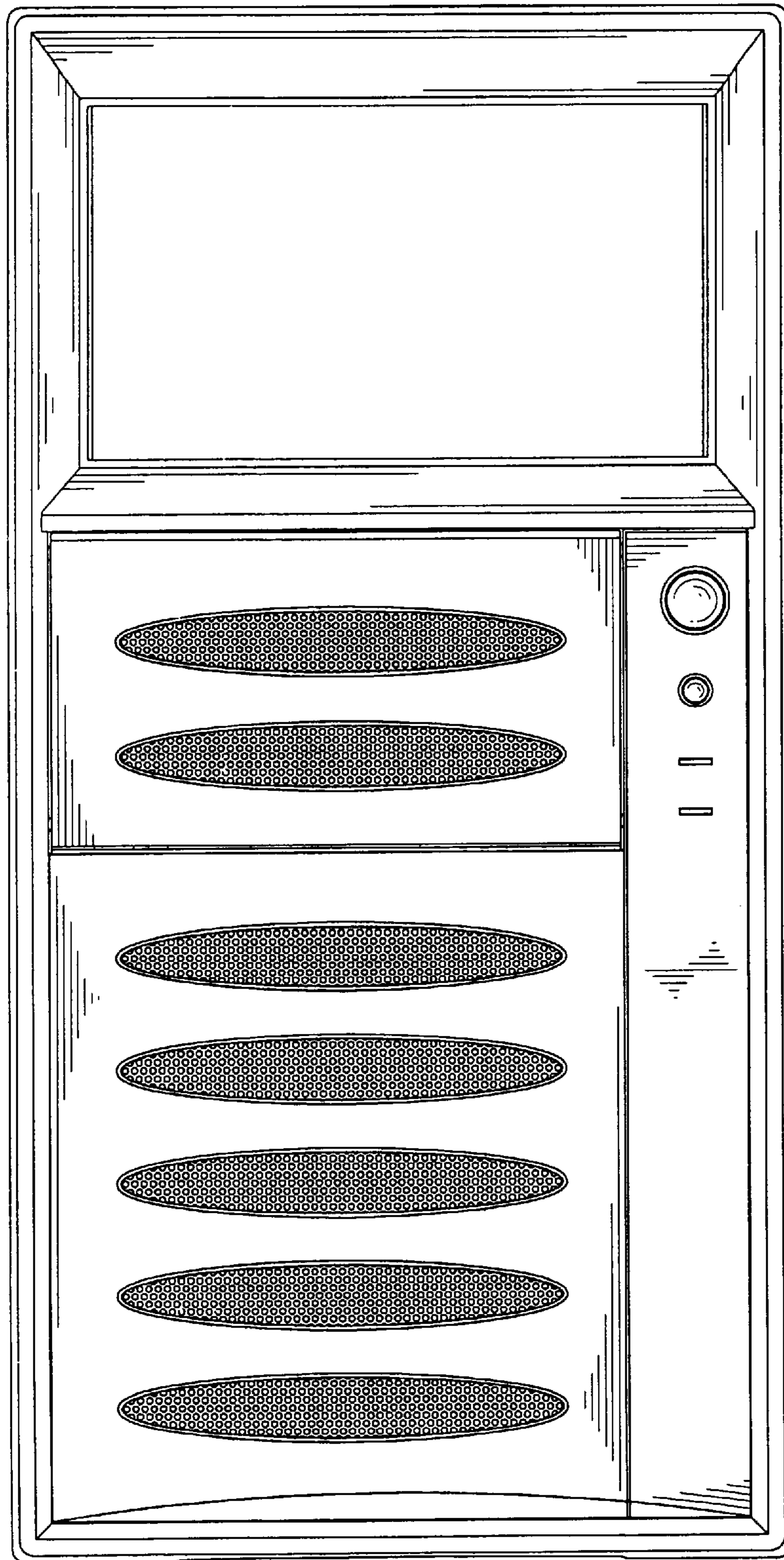

FIG. 2

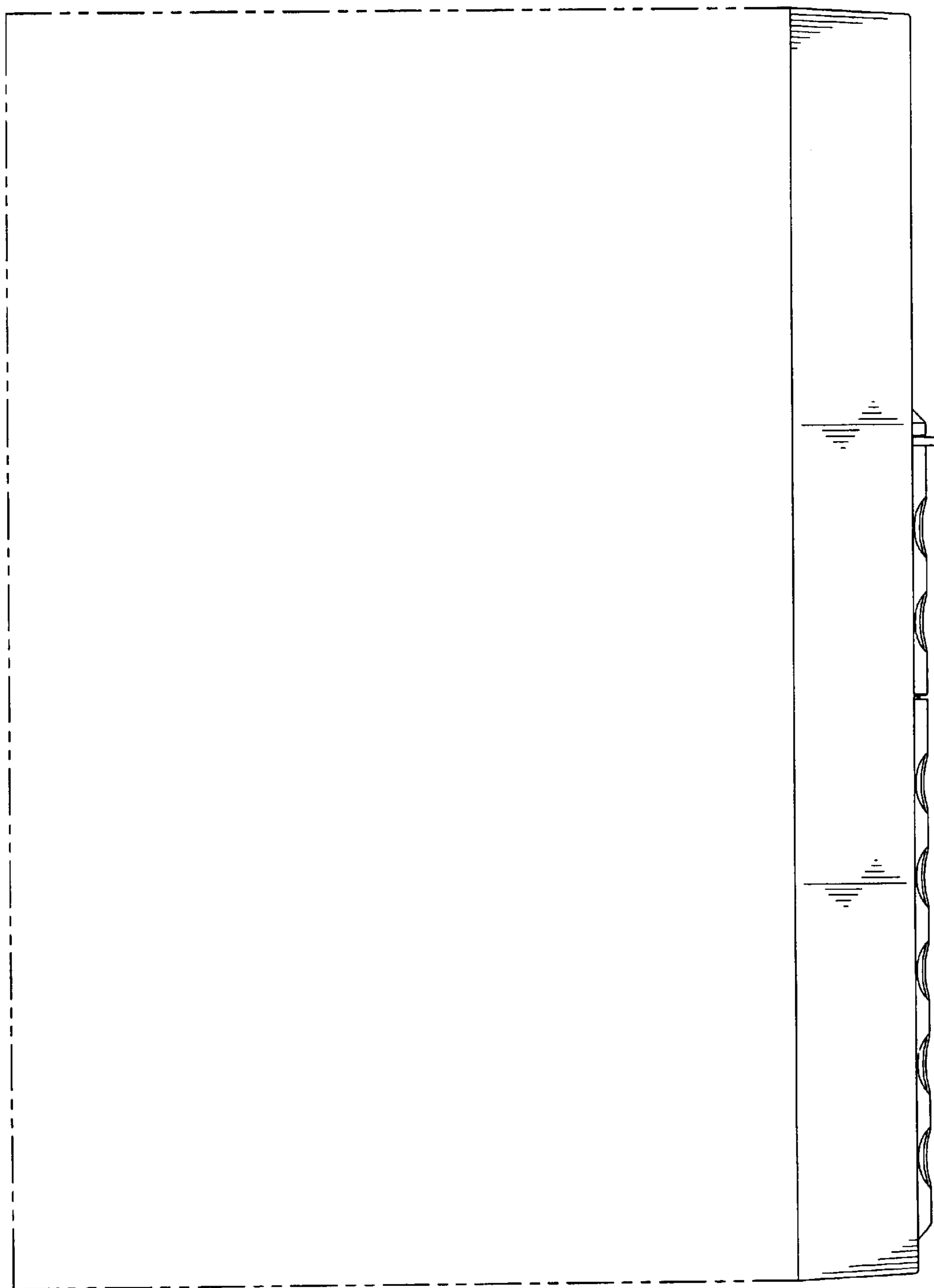

FIG. 3

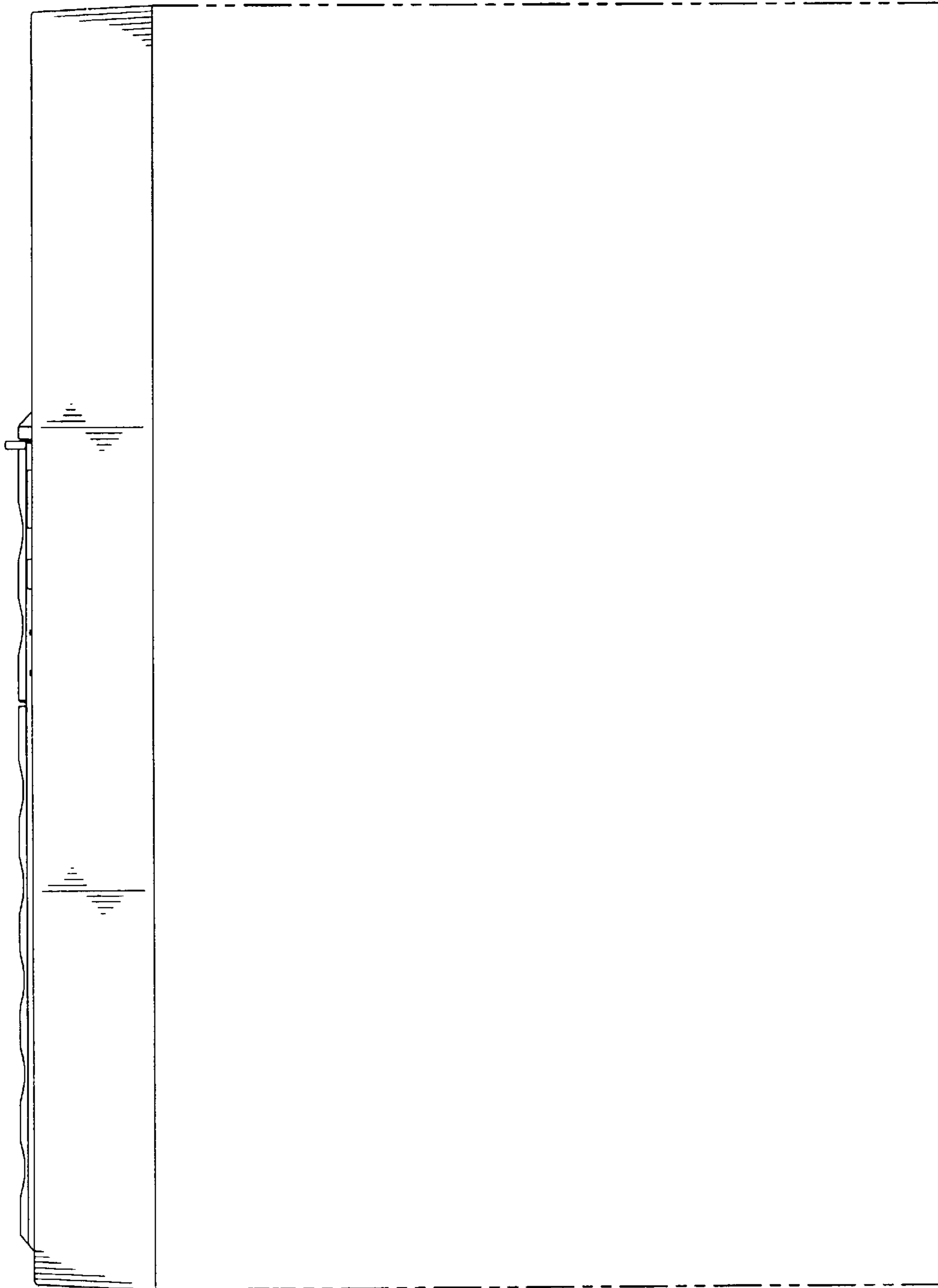

FIG. 4

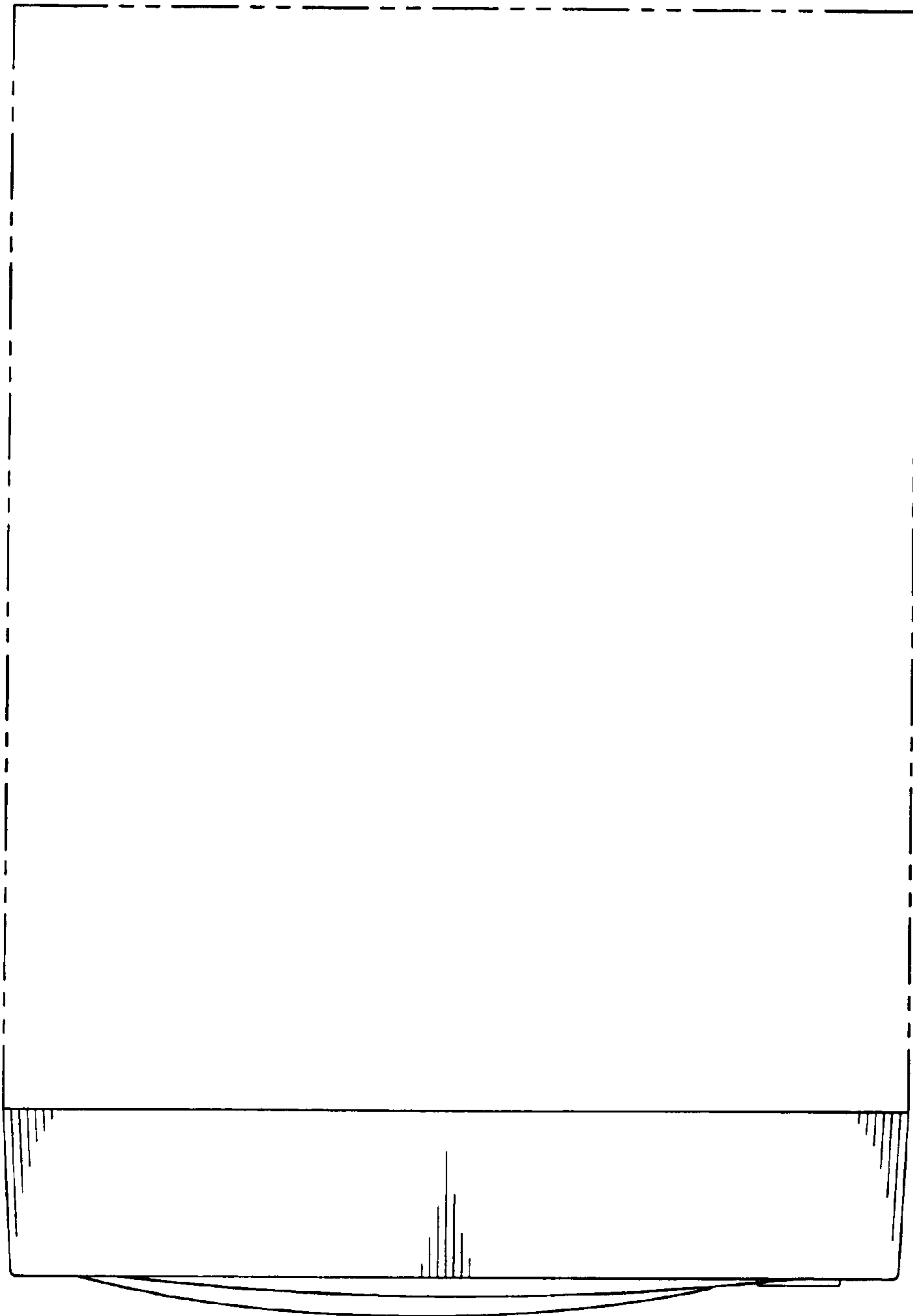

FIG. 5

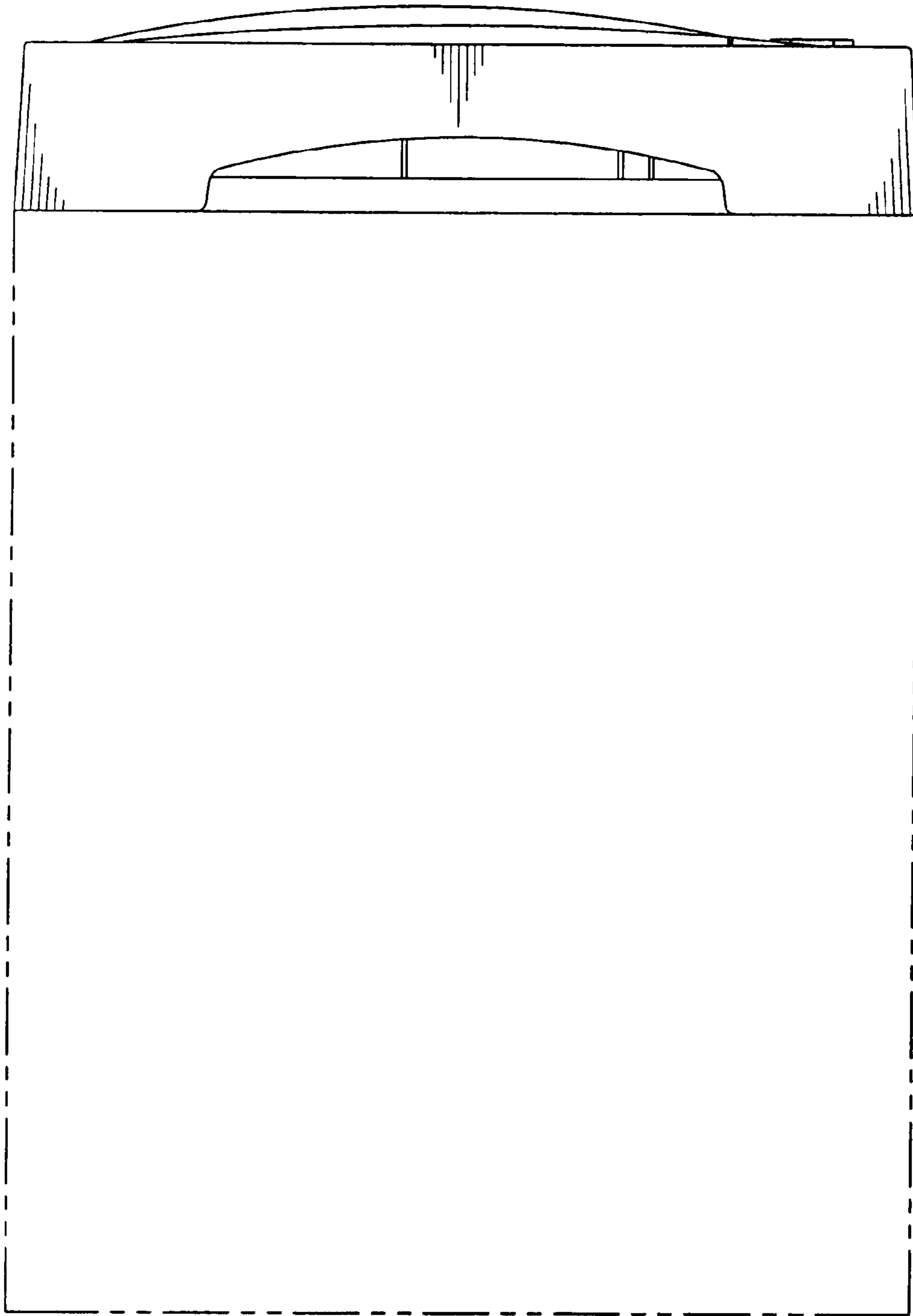

FIG. 6