



US00D527336S

(12) **United States Design Patent**  
**Van Baelen**

(10) **Patent No.:** **US D527,336 S**

(45) **Date of Patent:** **\*\* Aug. 29, 2006**

(54) **END CAP FOR A WIPER BLADE**

(75) Inventor: **David Van Baelen**, Herent (BE)

(73) Assignee: **Robert Bosch GmbH**, Stuttgart (DE)

(\*\*) Term: **14 Years**

(21) Appl. No.: **29/222,733**

(22) Filed: **Feb. 3, 2005**

(30) **Foreign Application Priority Data**

Aug. 23, 2004 (DE) ..... 4 04 04 804

(51) **LOC (8) Cl.** ..... **12-06**

(52) **U.S. Cl.** ..... **D12/220**

(58) **Field of Classification Search** ..... D12/219-220;  
15/250.451-250.454, 250.48, 250.361, 250.05-250.07,  
15/250.31-250.33, 250.351, 250.4-250.42,  
15/250.38

See application file for complete search history.

(56) **References Cited**

**U.S. PATENT DOCUMENTS**

D152,888 S \* 3/1949 Krohm ..... D12/220

D322,772 S \* 12/1991 Leu et al. .... D12/220

D393,619 S \* 4/1998 Jeffer et al. .... D12/220

6,038,729 A \* 3/2000 Feigenbaum ..... 15/250.41

D498,453 S \* 11/2004 Lee ..... D12/220

\* cited by examiner

*Primary Examiner*—Stacia Cadmus

(74) *Attorney, Agent, or Firm*—Michael J. Striker

(57) **CLAIM**

The ornamental design for an end cap for a wiper blade, as shown and described.

**DESCRIPTION**

FIG. 1 is a side perspective view of an end cap for a wiper blade showing my new design;

FIG. 2 is a side perspective view thereof, from the opposite side of FIG. 1;

FIG. 3 is a top view thereof;

FIG. 4 is a front view thereof;

FIG. 5 is a side view thereof; and,

FIG. 6 is the opposite side view of FIG. 5 thereof.

**1 Claim, 3 Drawing Sheets**

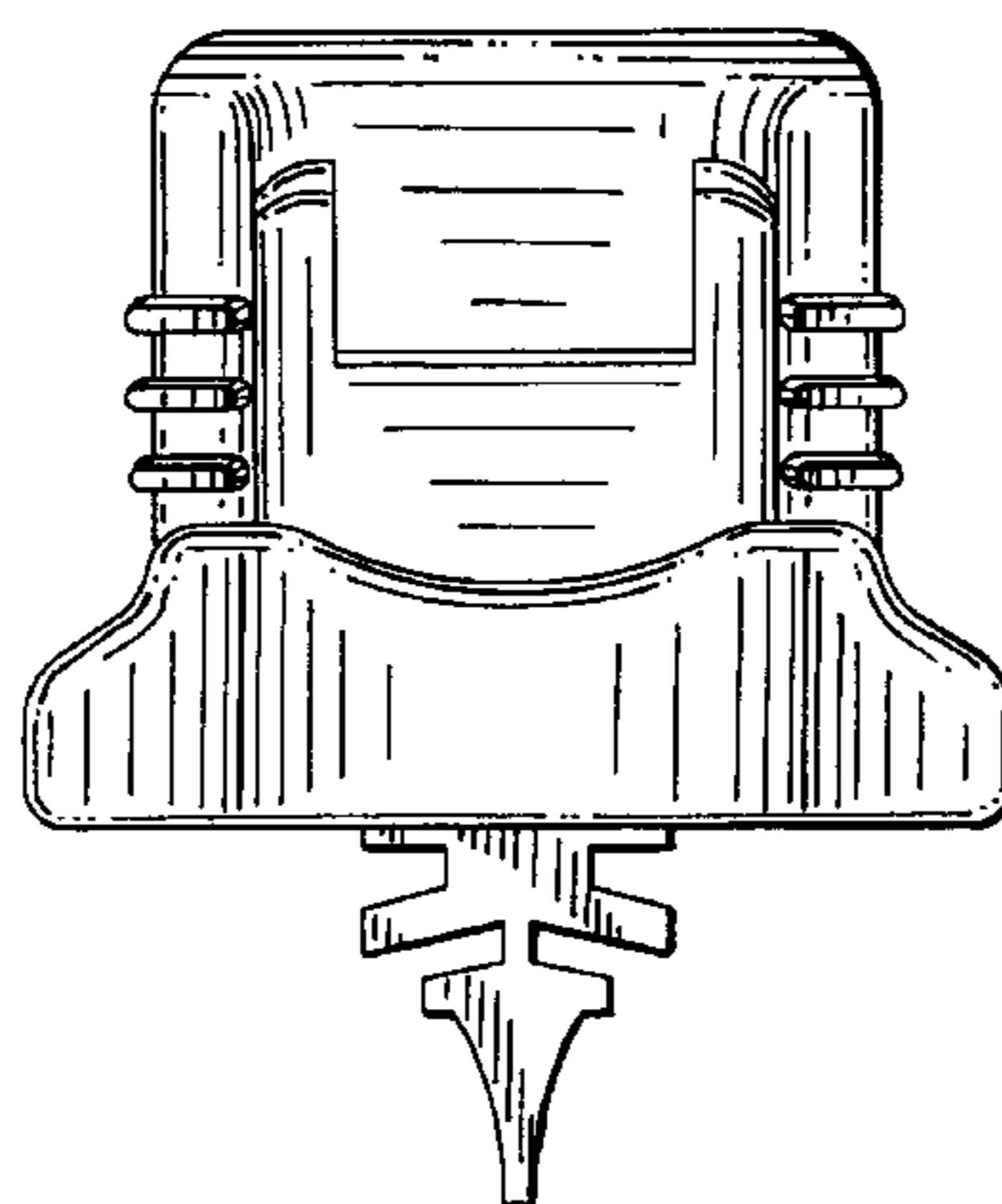
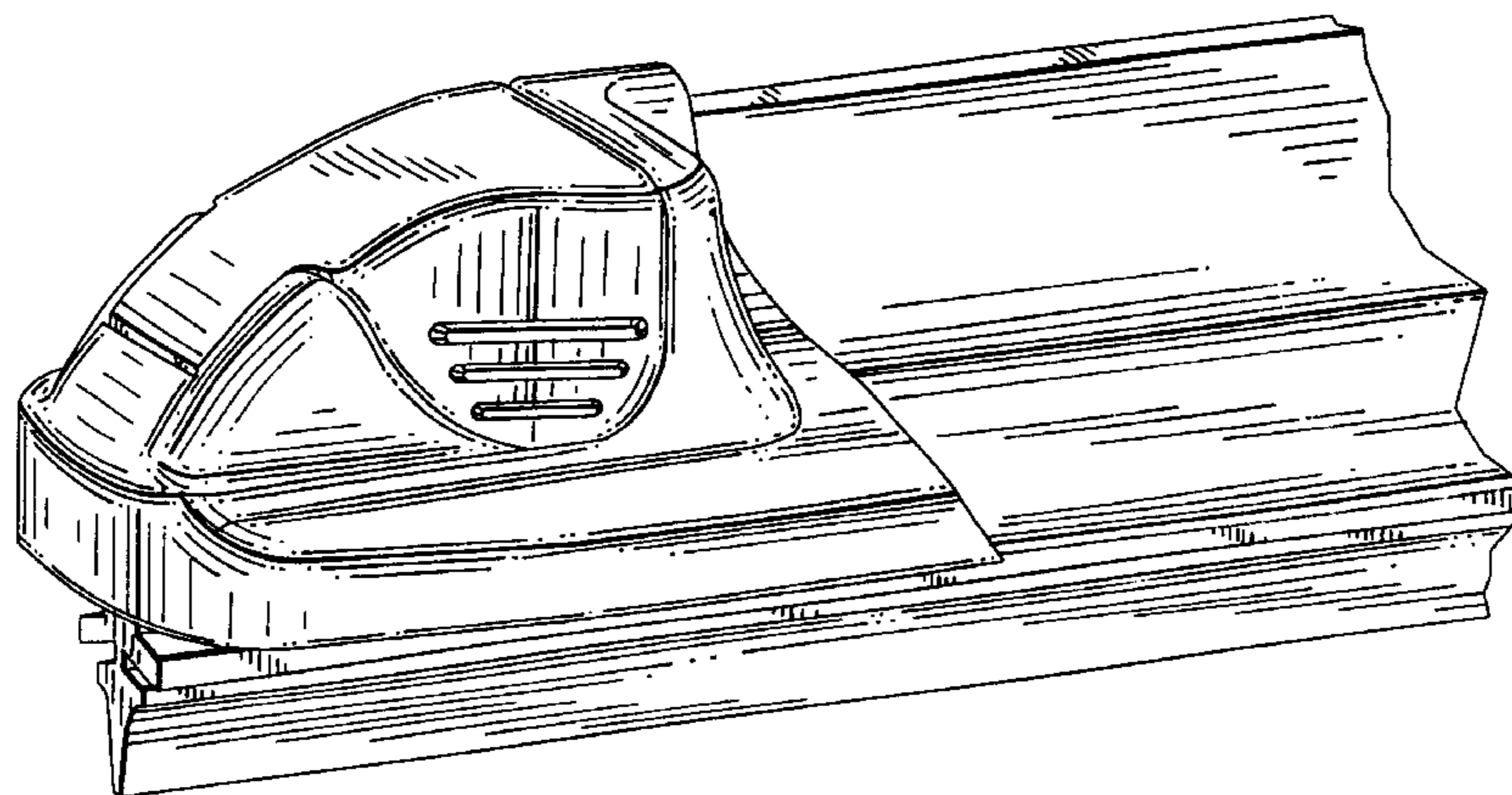

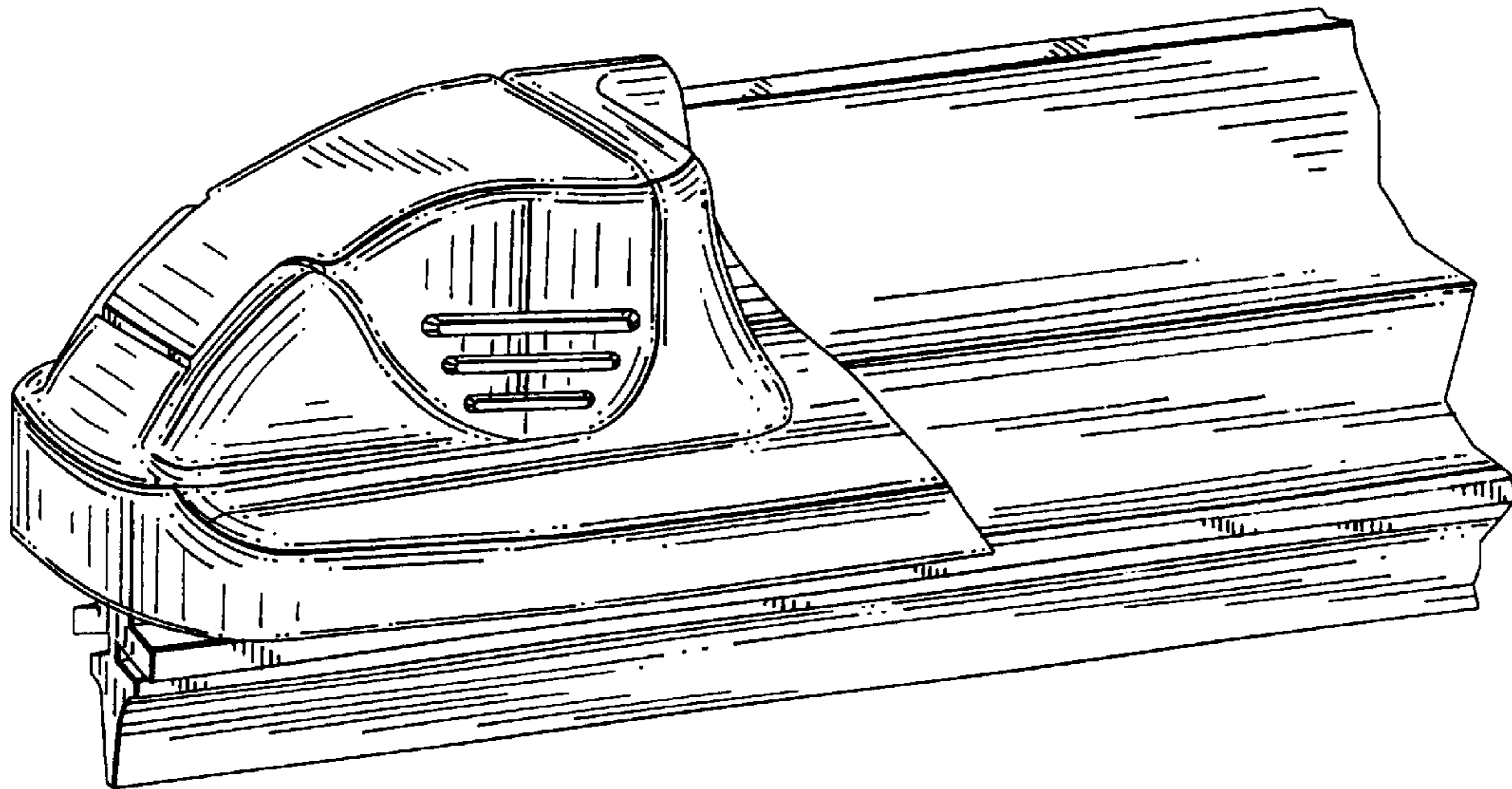

FIG. 1

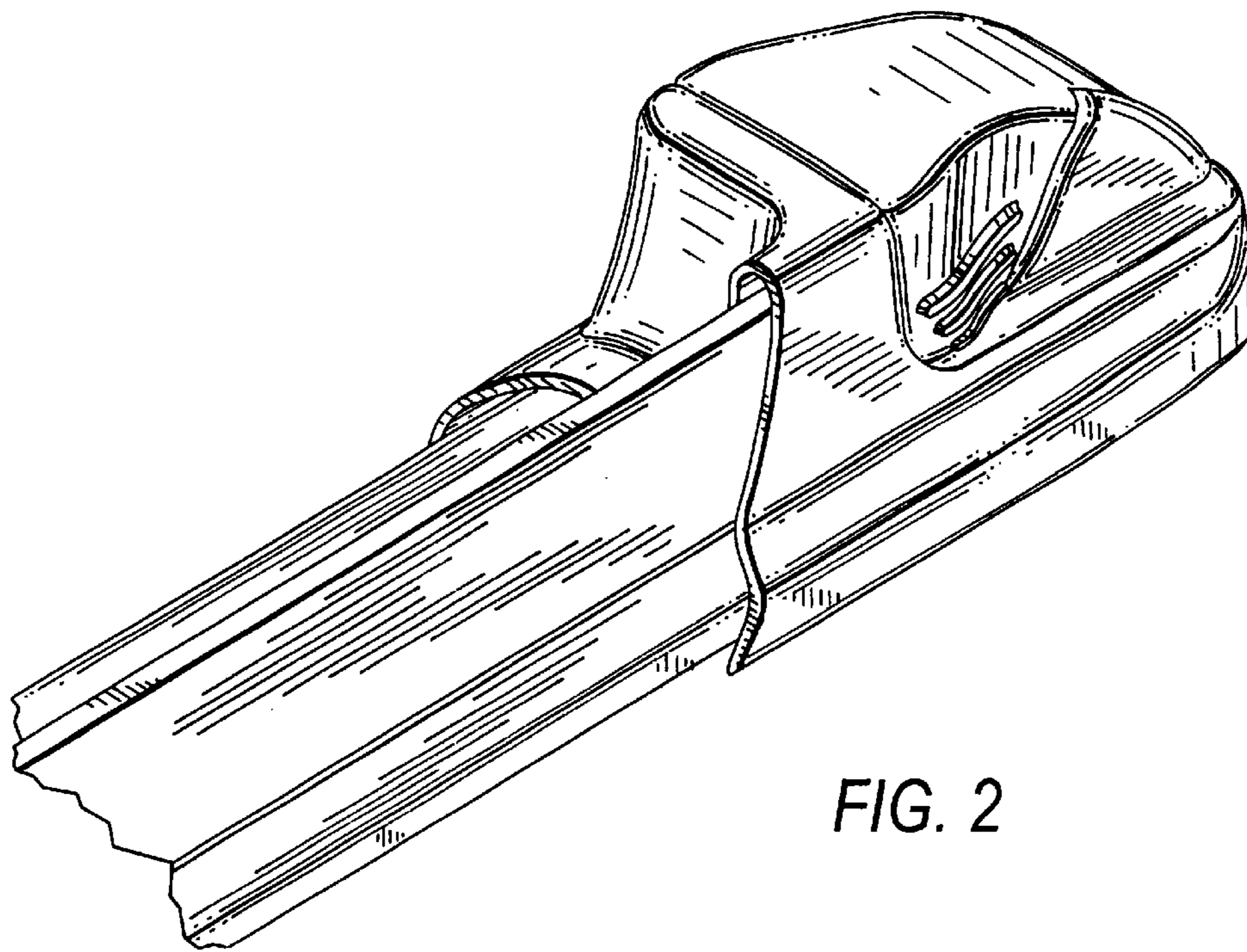

FIG. 2

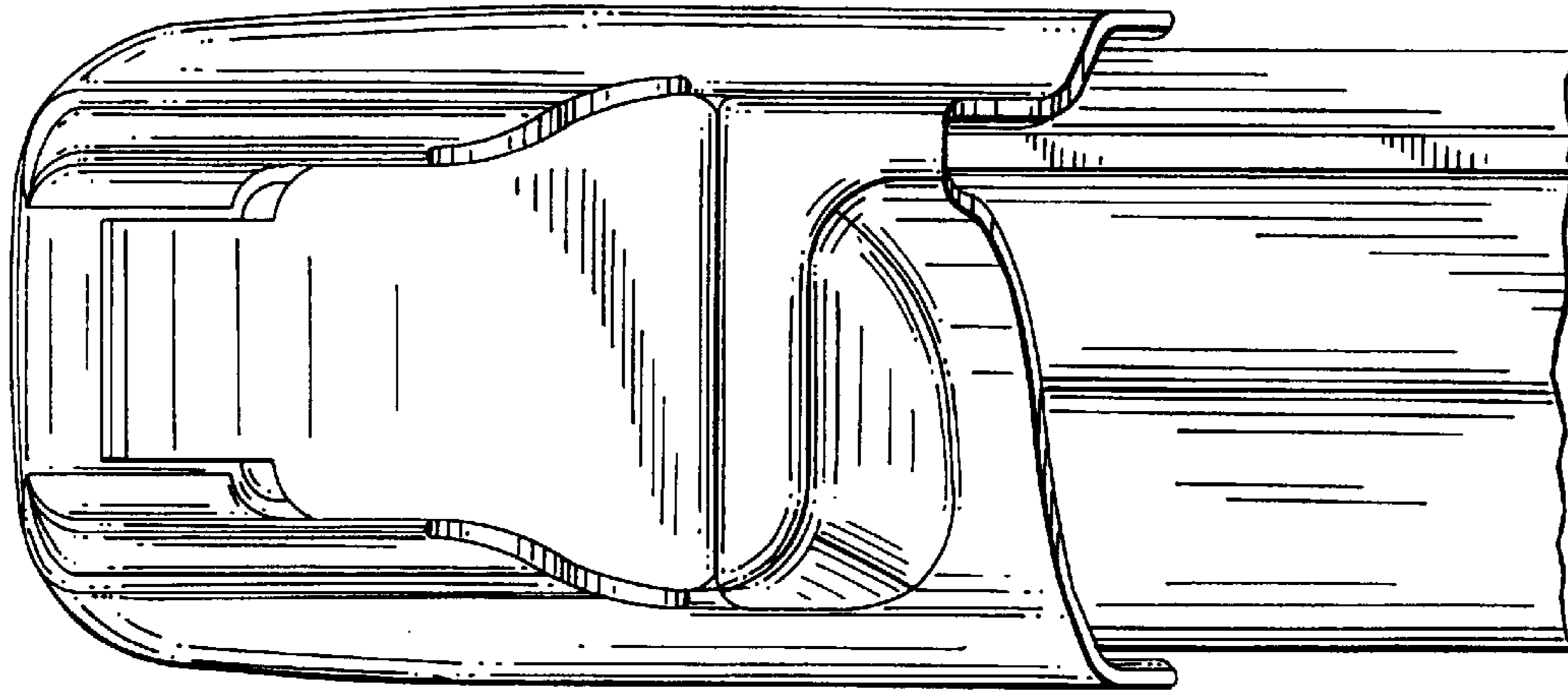

FIG. 3

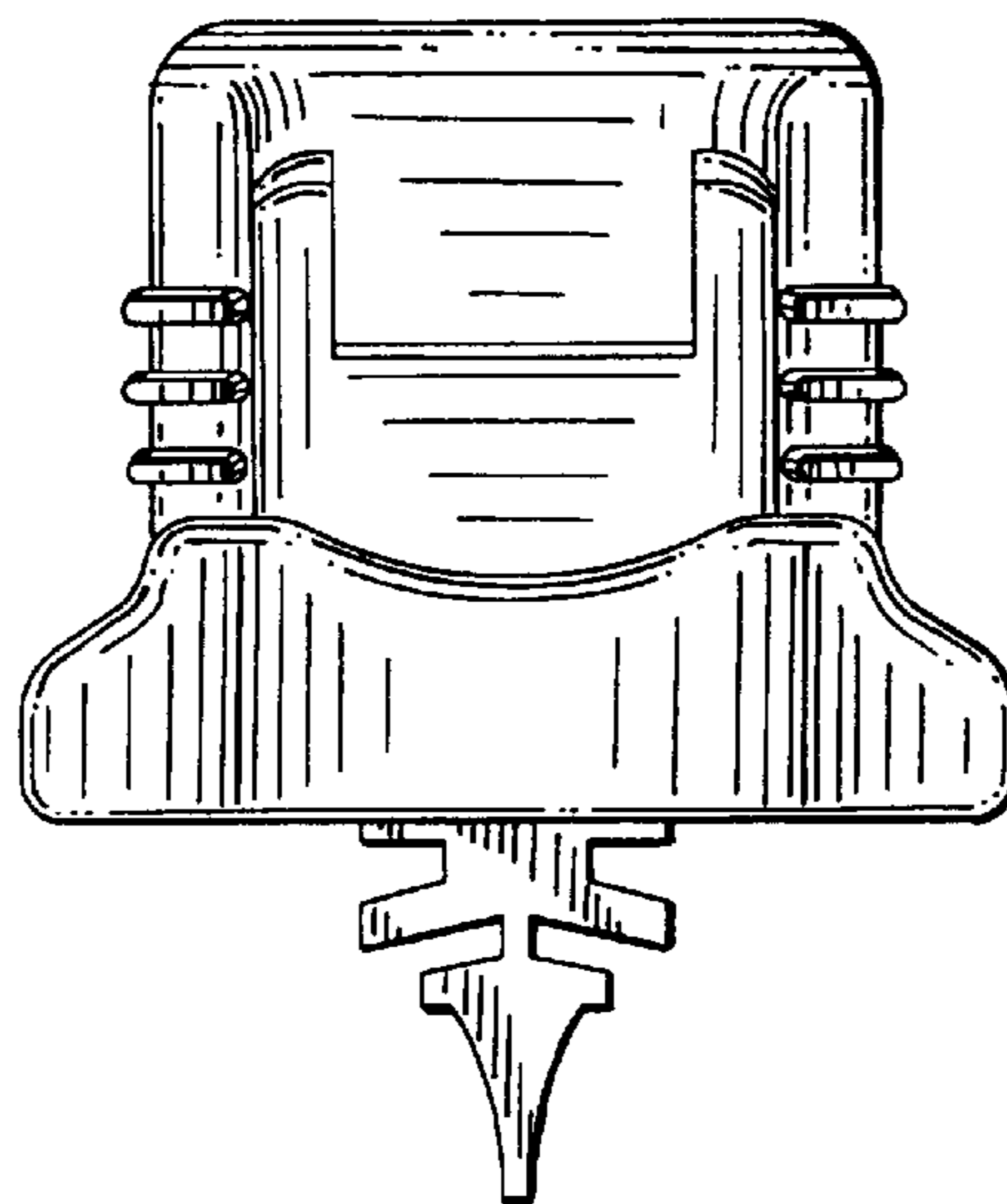

FIG. 4

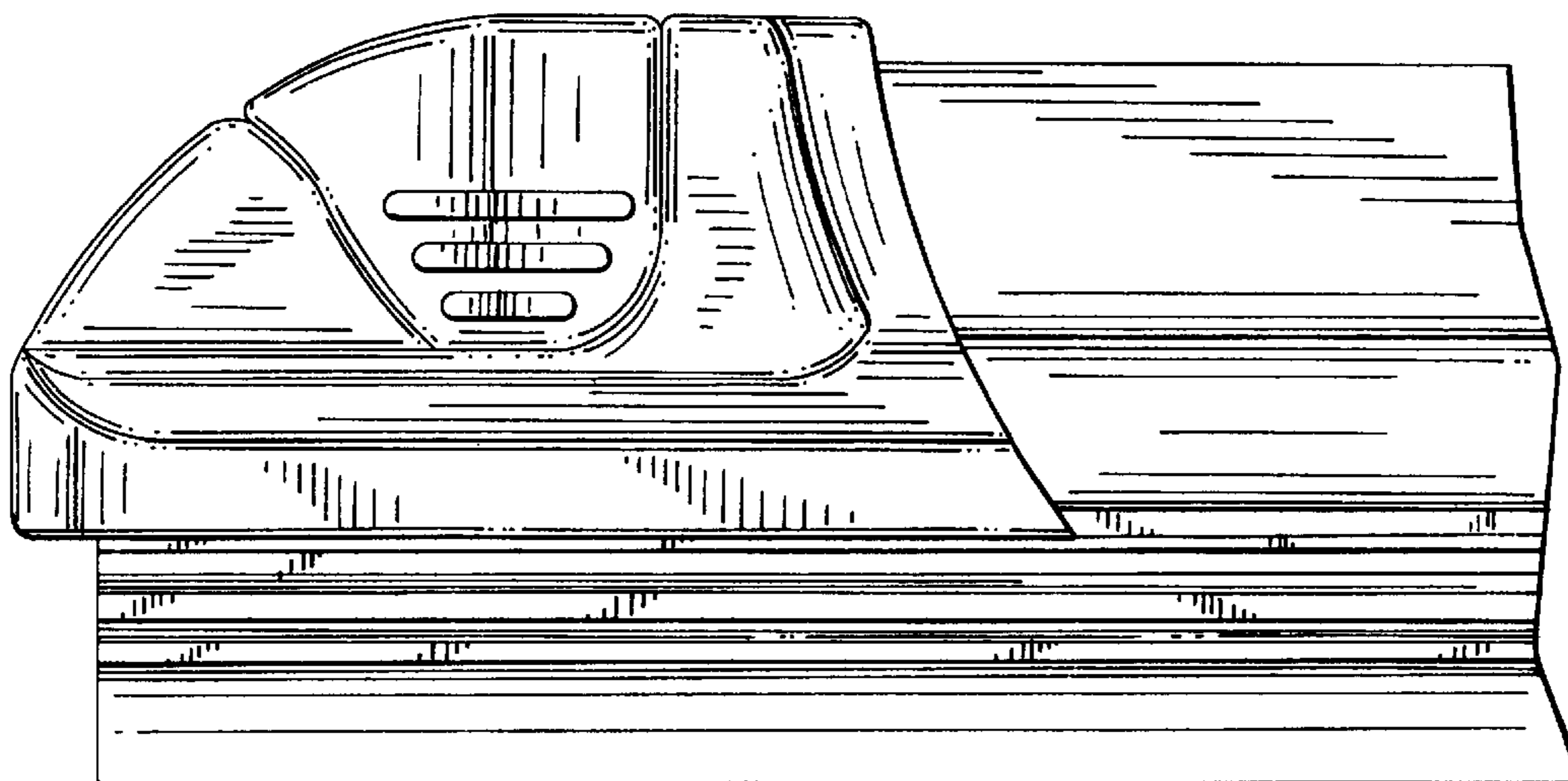

FIG. 5

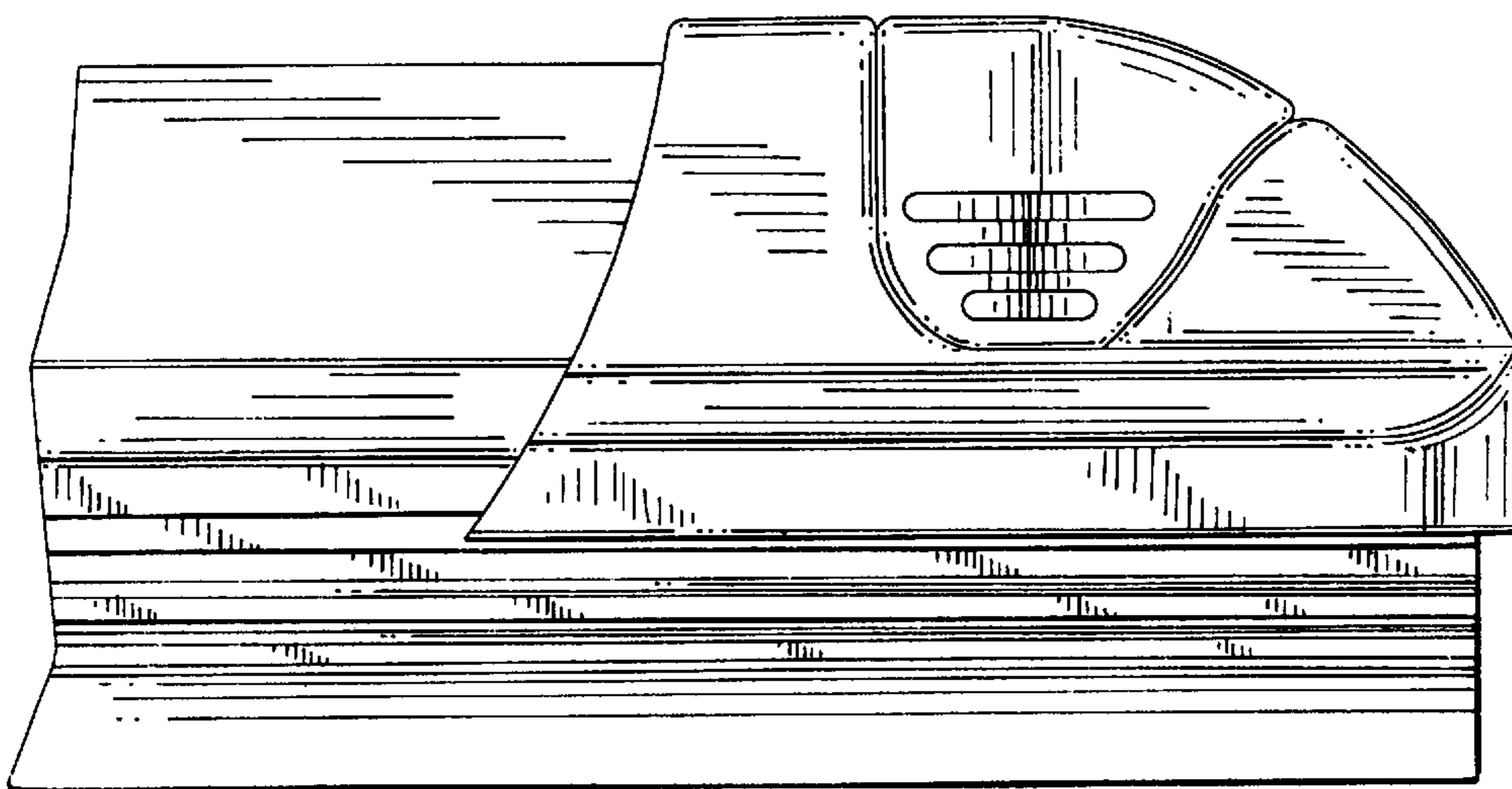

FIG. 6