



US00D527297S

(12) **United States Design Patent**  
**Calvani**

(10) **Patent No.:** **US D527,297 S**

(45) **Date of Patent:** **\*\* Aug. 29, 2006**

(54) **WATCH FACE**

(75) Inventor: **Maria Cristina Calvani**, Cologny (CH)

(73) Assignee: **Rolex Watch U.S.A., Inc.**, New York, NY (US)

(\*\*) Term: **14 Years**

(21) Appl. No.: **29/238,674**

(22) Filed: **Sep. 20, 2005**

(30) **Foreign Application Priority Data**

Mar. 22, 2005 (CH) ..... 131652

(51) **LOC (8) Cl.** ..... **10-05**

(52) **U.S. Cl.** ..... **D10/126**

(58) **Field of Classification Search** ..... D10/30-39,  
D10/122-129; 368/80, 223, 228-229, 232,  
368/276, 280-283, 285, 28-30, 21

See application file for complete search history.

(56) **References Cited**

**U.S. PATENT DOCUMENTS**

- D79,292 S \* 8/1929 Gruen ..... D10/125
- D79,293 S \* 8/1929 Gruen ..... D10/125
- D437,791 S \* 2/2001 Roden ..... D10/32
- D440,514 S \* 4/2001 Gruosi ..... D10/125
- D453,690 S \* 2/2002 D'Origny ..... D10/39
- D481,642 S \* 11/2003 Journe ..... D10/126
- D498,683 S \* 11/2004 Arabov ..... D10/39

**OTHER PUBLICATIONS**

Frank Edwards, *Wristwatches—A Connoisseur's Guide*, Firefly Books, Ltd., 1997, p. 92, 'Reverso Duo—1931' Watch by Jaeger-LeCoultre, located on the middle left side of page.\*  
Helmut Kahlert, Richard Muhe and Gisbert L. Brunner, *Wristwatches—History of a Century's Development*, Schiffer Publishings, Ltd., 1986, p. 186, Watch #111 'Rolex Prince—1947' and Watch #112a 'Longines Duo—Dial—1935', bottom of page.\*

Jewelers' Circular—Keystone Magazine, Mar. 1981, p. 5, 'Concord Marine SG' by Concord Quartz.\*

U.S. Appl. No. 29/238,676, filed Sep. 20, 2005, Maria Cristina Calvani.

U.S. Appl. No. 29/238,678, filed Sep. 20, 2005, Maria Cristina Calvani.

U.S. Appl. No. 29/238,616, filed Sep. 20, 2005, Maria Cristina Calvani.

U.S. Appl. No. 29/238,620, filed Sep. 20, 2005, Maria Cristina Calvani.

U.S. Appl. No. 29/238,617, filed Sep. 20, 2005, Maria Cristina Calvani.

U.S. Appl. No. 29/238,618, filed Sep. 20, 2005, Maria Cristina Calvani.

U.S. Appl. No. 29/238,619, filed Sep. 20, 2005, Maria Cristina Calvani.

U.S. Appl. No. 29/238,677, filed Sep. 20, 2005, Maria Cristina Calvani.

(Continued)

*Primary Examiner*—Caron D. Veynar

*Assistant Examiner*—Zenita I. Bennett

(74) *Attorney, Agent, or Firm*—Sughrue Mion, PLLC

(57) **CLAIM**

The ornamental design for a watch face, as shown.

**DESCRIPTION**

FIG. 1 is a top plan view of a watch face showing my new design;

FIG. 2 is a front elevational view thereof;

FIG. 3 is a right side elevational view thereof;

FIG. 4 is a bottom plan view thereof;

FIG. 5 is a rear elevational view thereof;

FIG. 6 is a left side elevational view thereof; and,

FIG. 7 is a perspective view of the top, front and right side thereof.

**1 Claim, 3 Drawing Sheets**

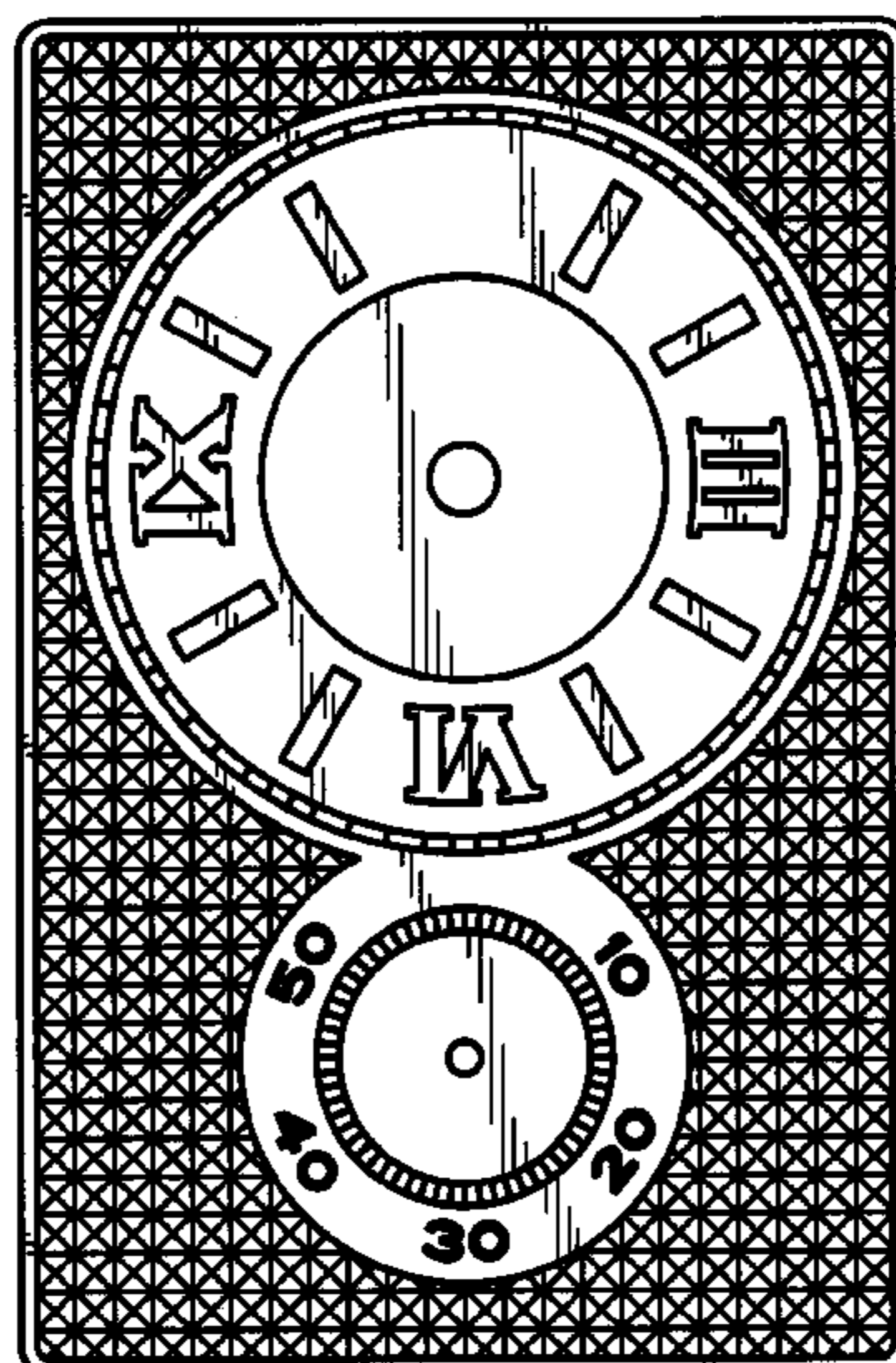

## OTHER PUBLICATIONS

- U.S. Appl. No. 29/238,673, filed Sep. 20, 2005, Maria Cristina Calvani.
- U.S. Appl. No. 29/238,615, filed Sep. 20, 2005, Maria Cristina Calvani.
- U.S. Appl. No. 29/238,675, filed Sep. 20, 2005, Maria Cristina Calvani.
- A. Lange & Söhne, Cabaret, Reference: 107.032, Annuario Di Orologi 2002/2003.
- A. Lange & Söhne, Arkade, Reference: 103.021, Annuario Di Orologi 2002/2003.
- A. Lange & Söhne, Arkade, Reference: 801.030, Annuario Di Orologi 2002/2003.
- A. Lange & Söhne, Grande Arkade, Reference: 106.032, Annuario Di Orologi 2002/2003.
- Audemars Piguet, Promesse, Reference: 67347BA.Z.1157 BA.01, Annuario Di Orologi 2002/2003.
- Audemars Piguet, Promesse, Reference: 67461BC.Z.00023LZ.01, Annuario Di Orologi 2002/2003.
- Audemars Piguet, Canapé, Reference: 15091BC.O.0002CR.02, Catalogue 2002.
- Audemars Piguet, Canapé, Reference: 15091B4.O.0002CR.01, Catalogue 2002.
- Audemars Piguet, Canapé, Reference: 6736OBC.O.0002CR.01, Catalogue 2002.
- Audemars Piguet, Reference: 15121OR.O.0002 CR.01, Catalogue 2002.
- Boucheron, Reflet Icare, Reference: WA005409, Annuario Di Orologi 2002/2003.
- Boucheron, Reflet Icare, Reference: WA005516, Annuario Di Orologi 2002/2003.
- Bréguet, Héritage, Reference: 3670BA/12/984, Annuario Di Orologi 2002/2003.
- Bulgari, Rettangolo, Reference: RT39GL, Annuario Di Orologi 2002/2003.
- Bulgari, Rettangolo, (compiled Jan. 2003).
- Bulova, Gold Collection Fashionable, Reference: BG 879 1, Annuario Di Orologi 2000/2001.
- Bulova, Gold Collection Gioielleria, Reference: BH 9381.2, Annuario Di Orologi 2002/2003.
- Bulova, Gold Collection Quartz Lady, Reference BH 9251.2, Annuario Di Orologi 2002/2003.
- Cartier, Tank Américaine, Reference: MM, Catalogue 2002.
- Cartier, Tank Américaine, Reference: GM, Catalogue 2002.
- Cartier, Tank Américaine, Reference: GM, Catalogue 2002.
- Chopard, Strada ?, Reference: 41/7423/8, Site Jan. 2003 (compiled Jan. 2003).
- Girard-Perregaux, Reference: 25960.051.1151, Catalogue 2001 (compiled Jan. 2003).
- Girard-Perregaux, Reference: 25960.51.2162, Catalogue 2001 (compiled Jan. 2003).
- Girard-Perregaux, Reference: 25960.052.6756, Catalogue 2001 (compiled Jan. 2003).
- Girard-Perregaux, Reference: 25960.052.1161, Catalogue 2001 (compiled Jan. 2003).
- Glashütte, 1845 Karree Piccoli Secondi, Reference: 42-05-01-02-04, Annuario Di Orologi 2002/2003.
- Graham, Sprint, Reference: GR-SPR-OR-3PA, Annuario Di Orologi 2002/2003.
- Jaeger-LeCoultre, Reverso Memory, Reference: 255.140.822 B, Annuario Di Orologi 2000/2001.
- Jaeger-LeCoultre, Reverso Grande Taille, Reference: 270.340627 EB, Annuario Di Orologi 2000/2001.
- Jaeger-LeCoultre, Reverso Art Déco, Reference: 270.240.623 B, Annuario Di Orologi 2000/2001.
- Parmigiani, Forma Hebdomadaire, Reference: PF005716, Annuario Di Orologi 2002/2003.
- Patek Philippe, Gondolo Cabriolet, Reference: 5099RG, Annuario Di Orologi 2000/2001.
- Patek Philippe, Pagoda, (compiled Jan. 2003).
- Patek Philippe, Gondolo 5010, Reference: 5010J, (compiled Jan. 2003).
- Patek Philippe, Gondolo, Reference: 5024, (compiled Jan. 2003).
- Patek Philippe, Gondolo, Reference: 5024, (compiled Jan. 2003).
- Patek Philippe, Gondolo, Reference: 5014, (compiled Jan. 2003).
- Longines, Dolce Vita Classic, Reference: L5.502.6.16.6, (Catalogue 2000 / compiled Jan. 2003).
- Longines, Dolce Vita Classic, Reference: L5.655.6.16, (Catalogue 2000 / compiled Jan. 2003).
- Longines, Dolce Vita Classic, Reference L5.166.6.16.2, Annuario Di Orologi 2002/2003.
- Muller Franck, Cintré Curvex Gran Data, Reference: 2851 LTD, Annuario Di Orologi 2002/2003.
- Tiffany, Mark Regulator, listed Sep. 2002.
- Vacheron Constantin, Piccoli Secondi Rettangolare Anse A Goccia, Reference: 91001/000J, Annuario Di Orologi 2000/2001.
- Auguste Reymond, Charleston Maxi, (compiled Nov. 2004).
- Auguste Reymond, Classique, (compiled Nov. 2004).
- Auguste Reymond, Diva, (compiled Nov. 2004).
- Baume & Mercier, (compiled Nov. 2004).
- Bedat & Co., Geneve, (compiled Nov. 2004).
- Boucheron, Suivant, (compiled Nov. 2004).
- Boucheron, Precedent Suivant, (compiled Nov. 2004).
- Boucheron, Precedent Retour, (compiled Nov. 2004).
- Boucheron, Suivant, (compiled Nov. 2004).
- Bulgari, (compiled Nov. 2004).
- Cartier, (compiled Nov. 2004).
- Dolce & Gabbana, Nov. 2004 (Chrono World, May 2002).
- Ebel, 1911 La Carree, 2004, (compiled Nov. 2004).
- Ebel, Tarawa, 2004, (compiled Nov. 2004).
- Harry Winston, The Avenue Collection, (compiled Nov. 2004).
- Eberhard & Co., 40034 Les Courbees, (compiled Nov. 2004).
- Laco (circa 1940), Chrono World 2002.
- Lanvin, (compiled Nov. 2004).
- Piaget, (compiled Nov. 2004).
- Michel Yacare, (compiled Nov. 2004).
- Yves Saint Laurent, (compiled Nov. 2004).

\* cited by examiner

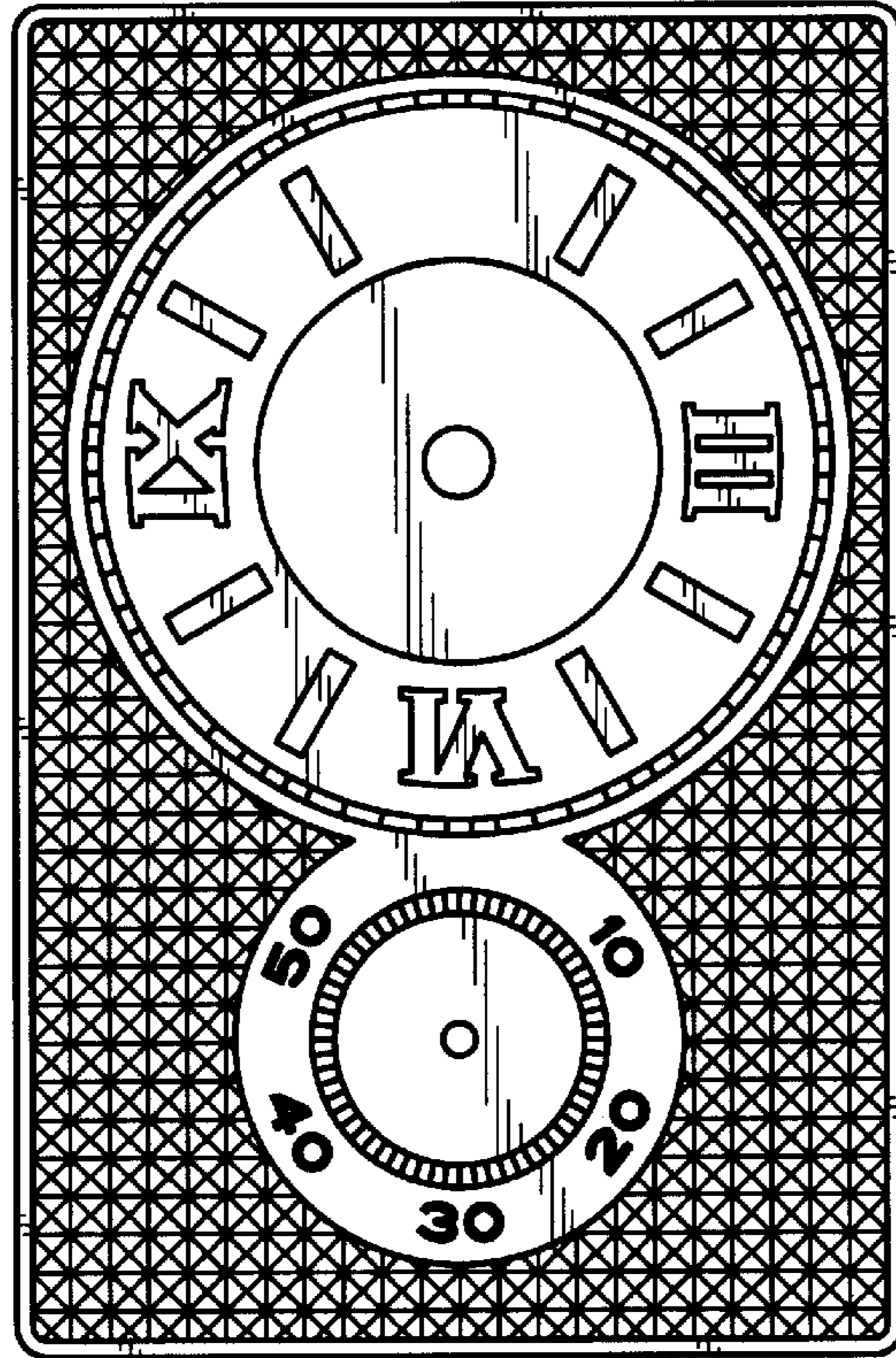

*Fig. 1*

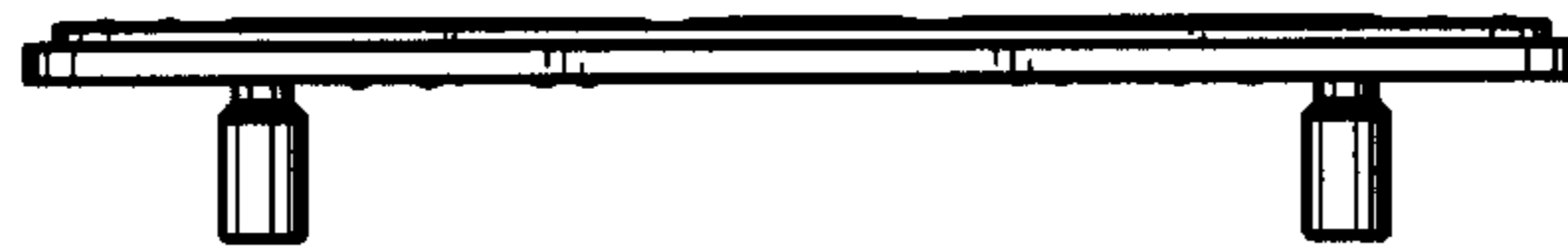

*Fig. 2*

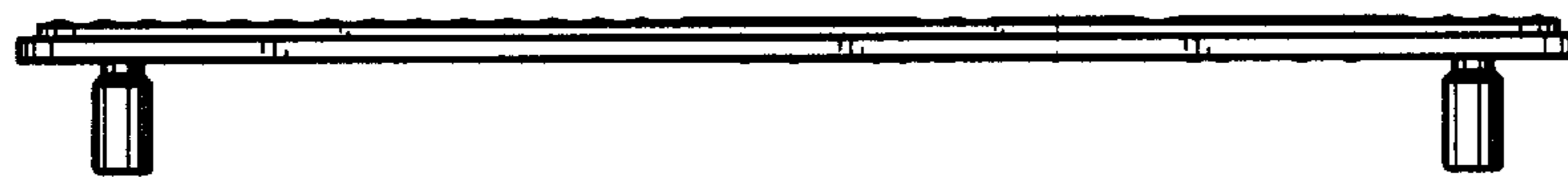

*Fig. 3*

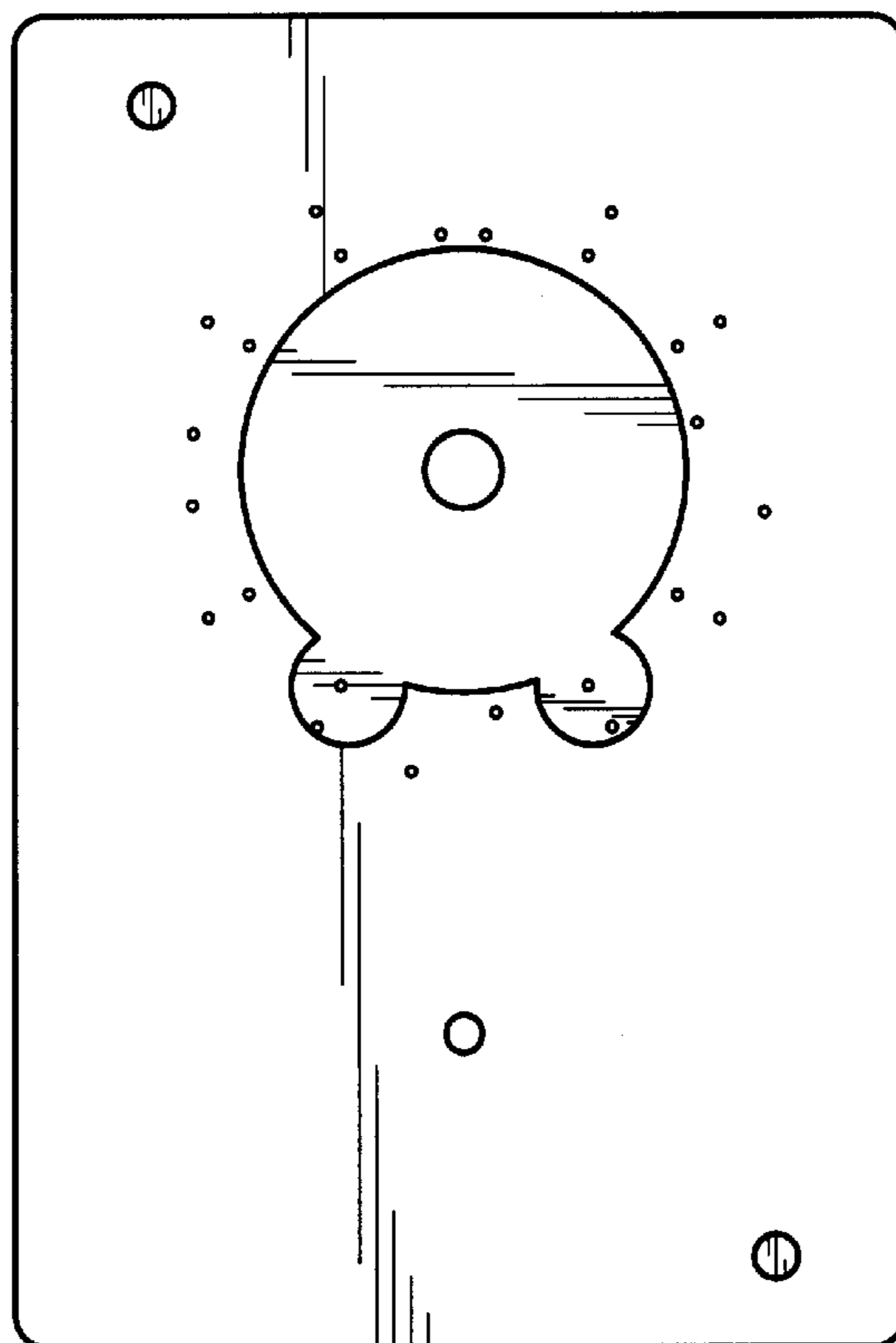

*Fig. 4*



*Fig. 5*

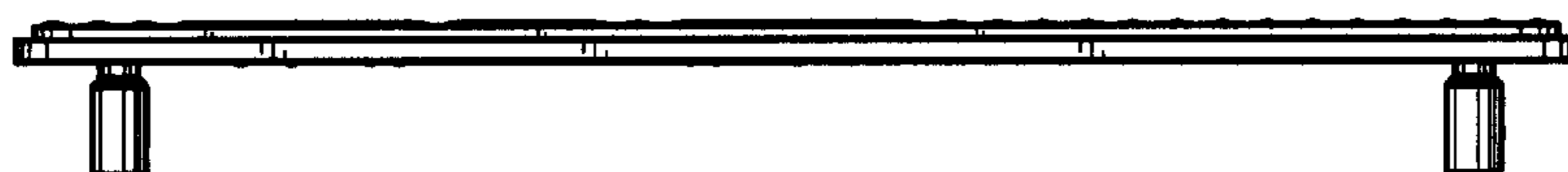

*Fig. 6*

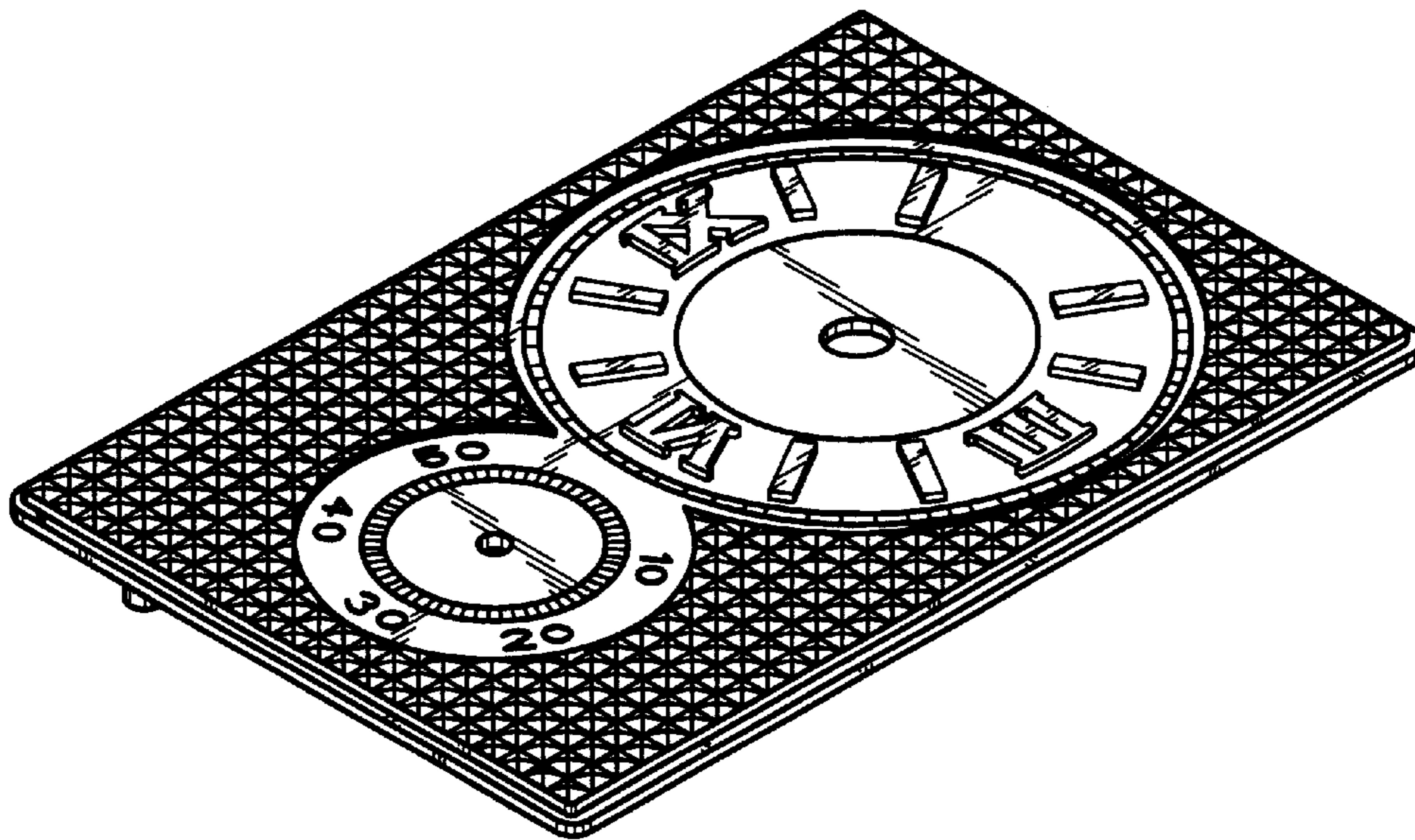

*Fig. 7*