



US00D527227S

(12) **United States Design Patent**  
**Bertulis**

(10) **Patent No.:** **US D527,227 S**

(45) **Date of Patent:** **\*\* Aug. 29, 2006**

(54) **FOOD CARRIER**

D418,021 S \* 12/1999 Terracciano et al. .... D7/605

(75) Inventor: **Eugenia Bertulis**, Seattle, WA (US)

\* cited by examiner

(73) Assignee: **Progressive International Corporation**, Kent, WA (US)

*Primary Examiner*—Terry A. Wallace

(74) *Attorney, Agent, or Firm*—Black Lowe & Graham, PLLC

(\*\*) Term: **14 Years**

(57) **CLAIM**

(21) Appl. No.: **29/205,505**

The ornamental design for a food carrier, as shown and described.

(22) Filed: **May 14, 2004**

**DESCRIPTION**

(51) **LOC (8) Cl.** ..... **07-01**

(52) **U.S. Cl.** ..... **D7/629**

(58) **Field of Classification Search** ..... D7/601,  
D7/602, 612–615, 629; D9/414–432; 219/729,  
219/734, 736; 220/360, 366, 780–806, 912,  
220/913, 574; 229/406, 407, 902–906

See application file for complete search history.

FIG. 1 is a perspective view of the food carrier, depicting a base and a lid, with the lid removed;

FIG. 2 is a top view of the lid;

FIG. 3 is a bottom view of the lid;

FIG. 4 is a left side view of the lid, the right side view being identical;

FIG. 5 is a front view of the lid, the back view being identical;

FIG. 6 is a left side view of the base, the right side view being identical;

FIG. 7 is a front view of the base, the back view being identical;

FIG. 8 is a top view of the base; and,

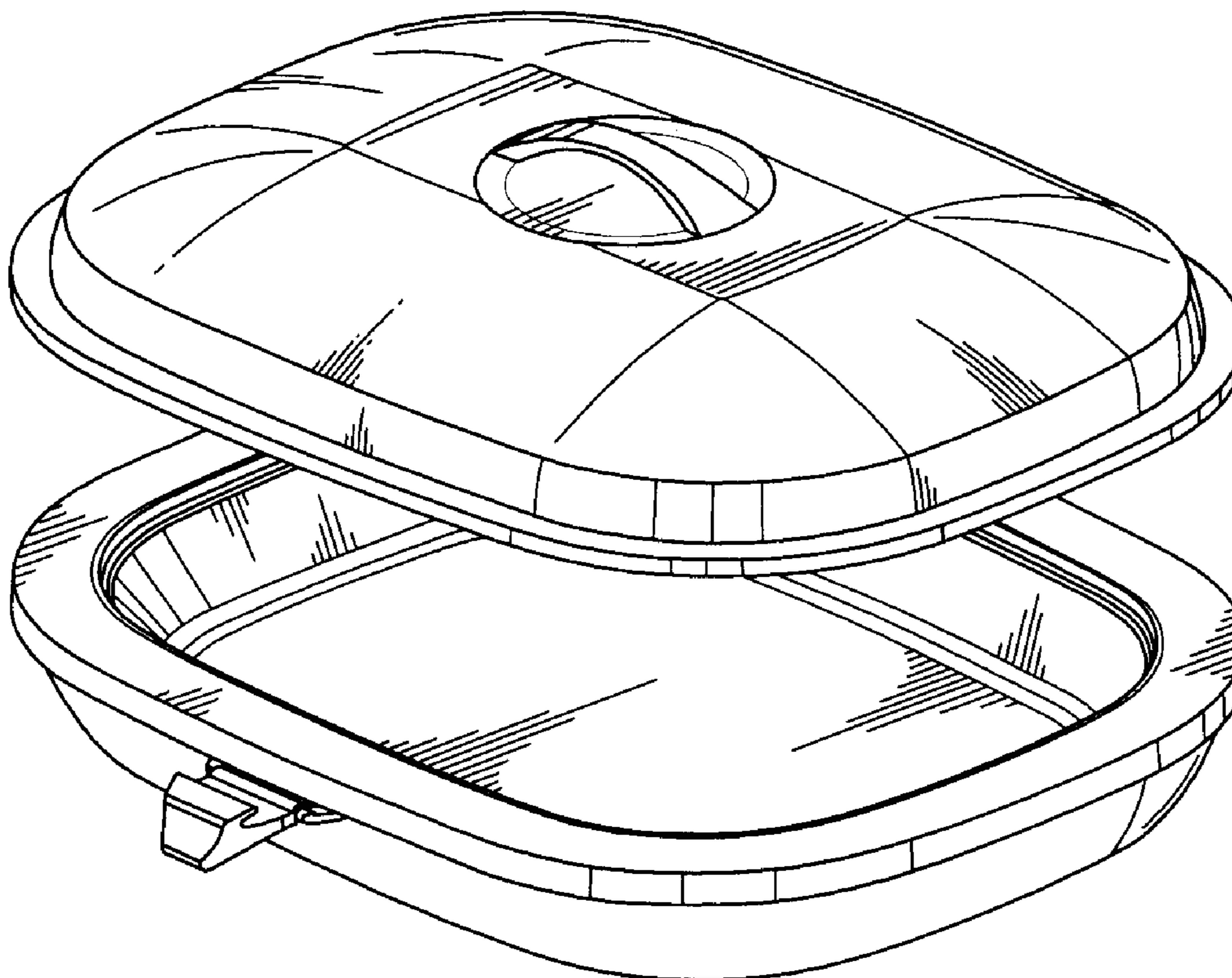
FIG. 9 is a bottom view of the base.

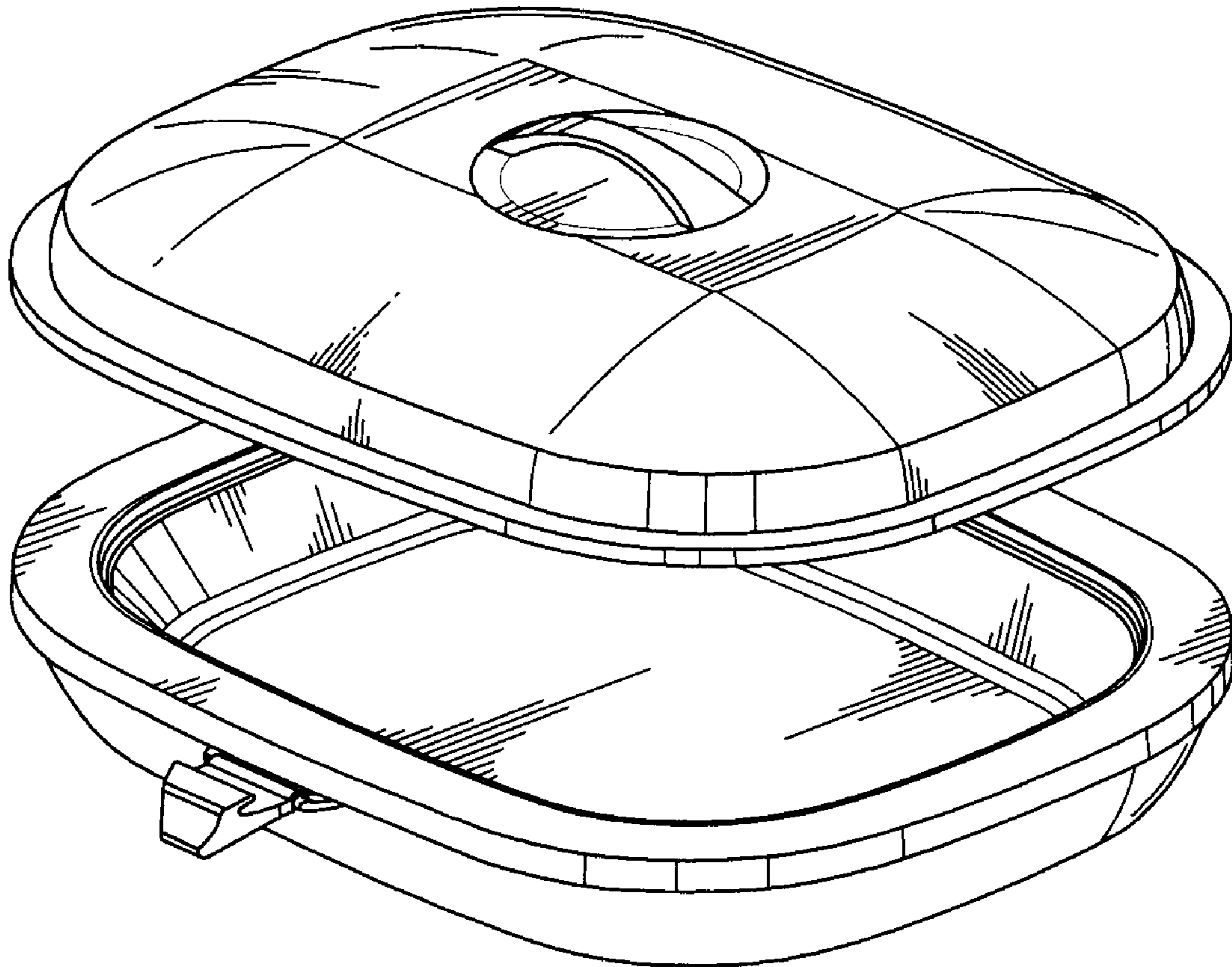
(56) **References Cited**

**U.S. PATENT DOCUMENTS**

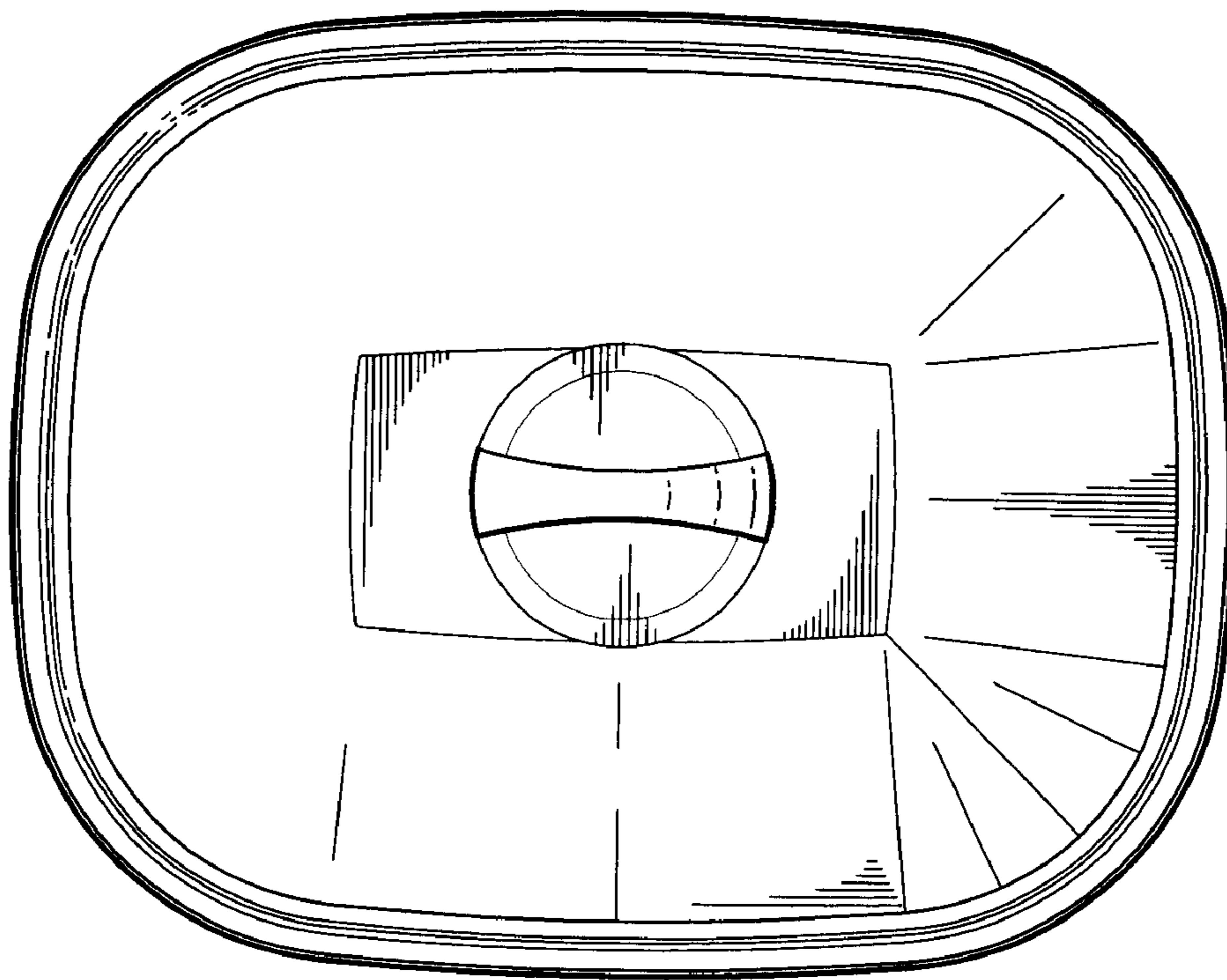
- D357,161 S \* 4/1995 Booten ..... D7/605
- 5,415,309 A \* 5/1995 Wang ..... 220/735
- 5,701,757 A \* 12/1997 Heverly ..... 62/457.2
- 5,704,485 A \* 1/1998 Cautereels et al. .... 62/457.1

**1 Claim, 4 Drawing Sheets**

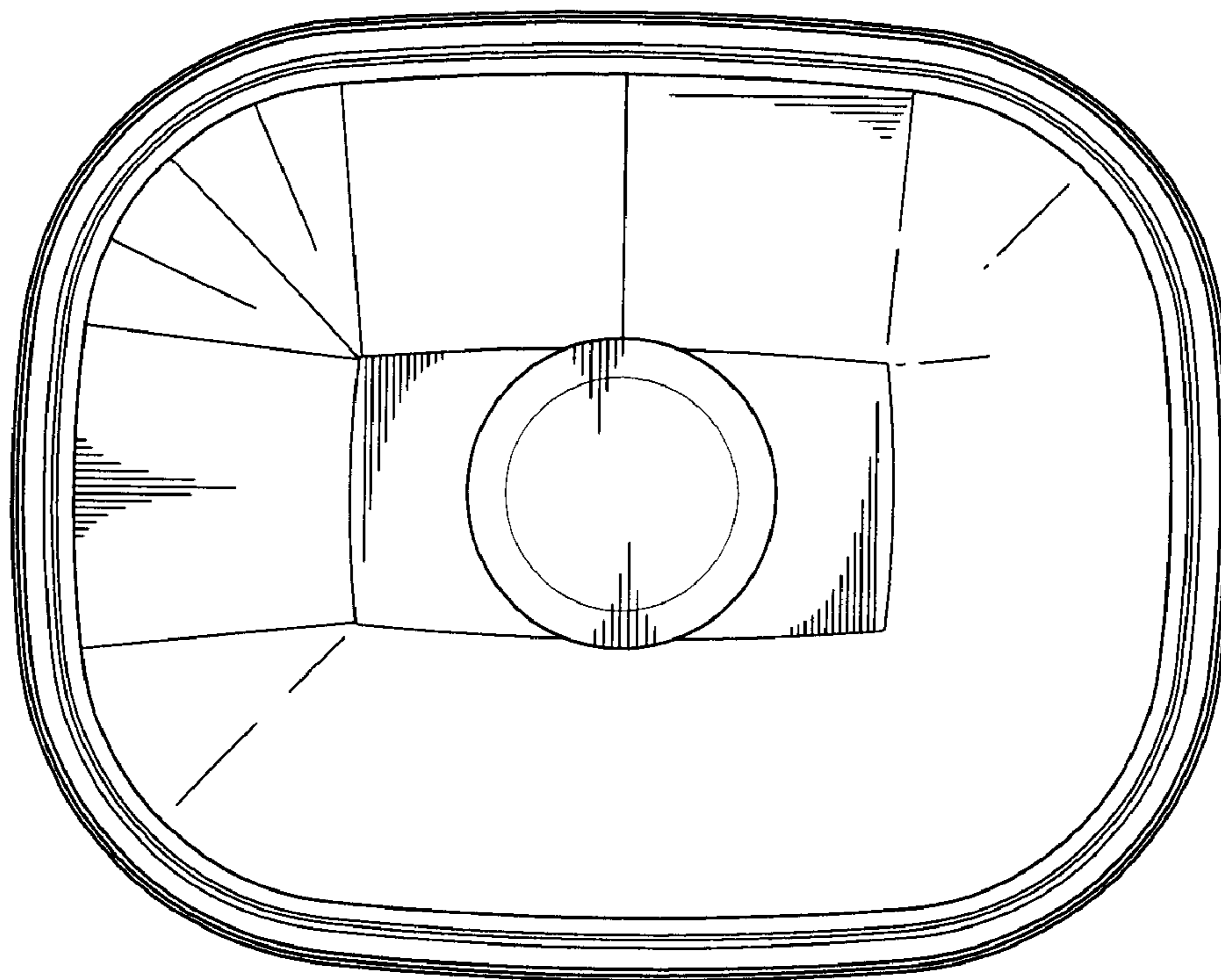




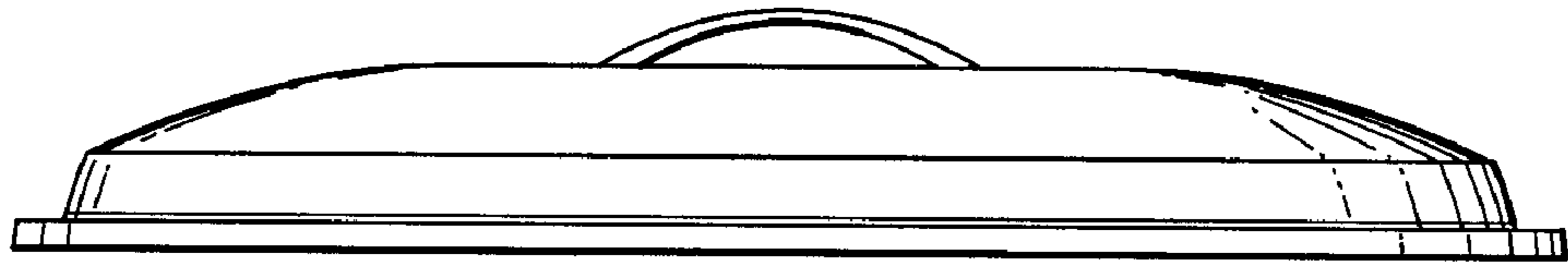
*Fig.1*



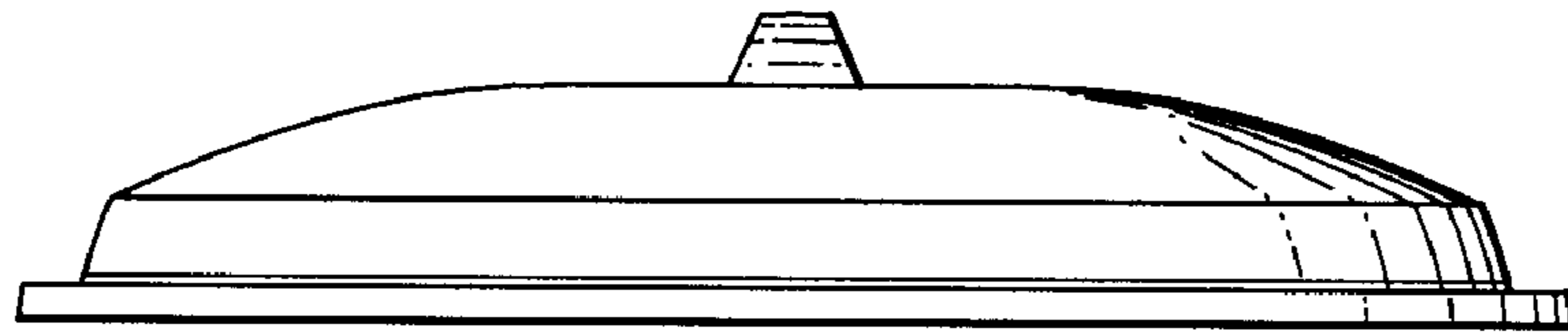
*Fig. 2*



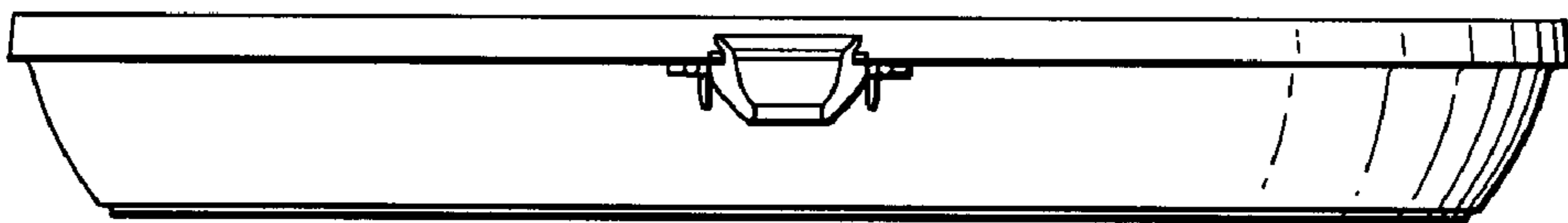
*Fig. 3*



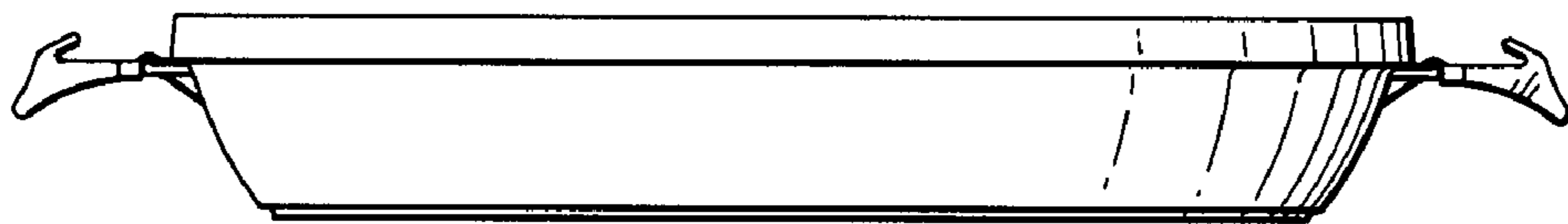
*Fig. 4*



*Fig. 5*

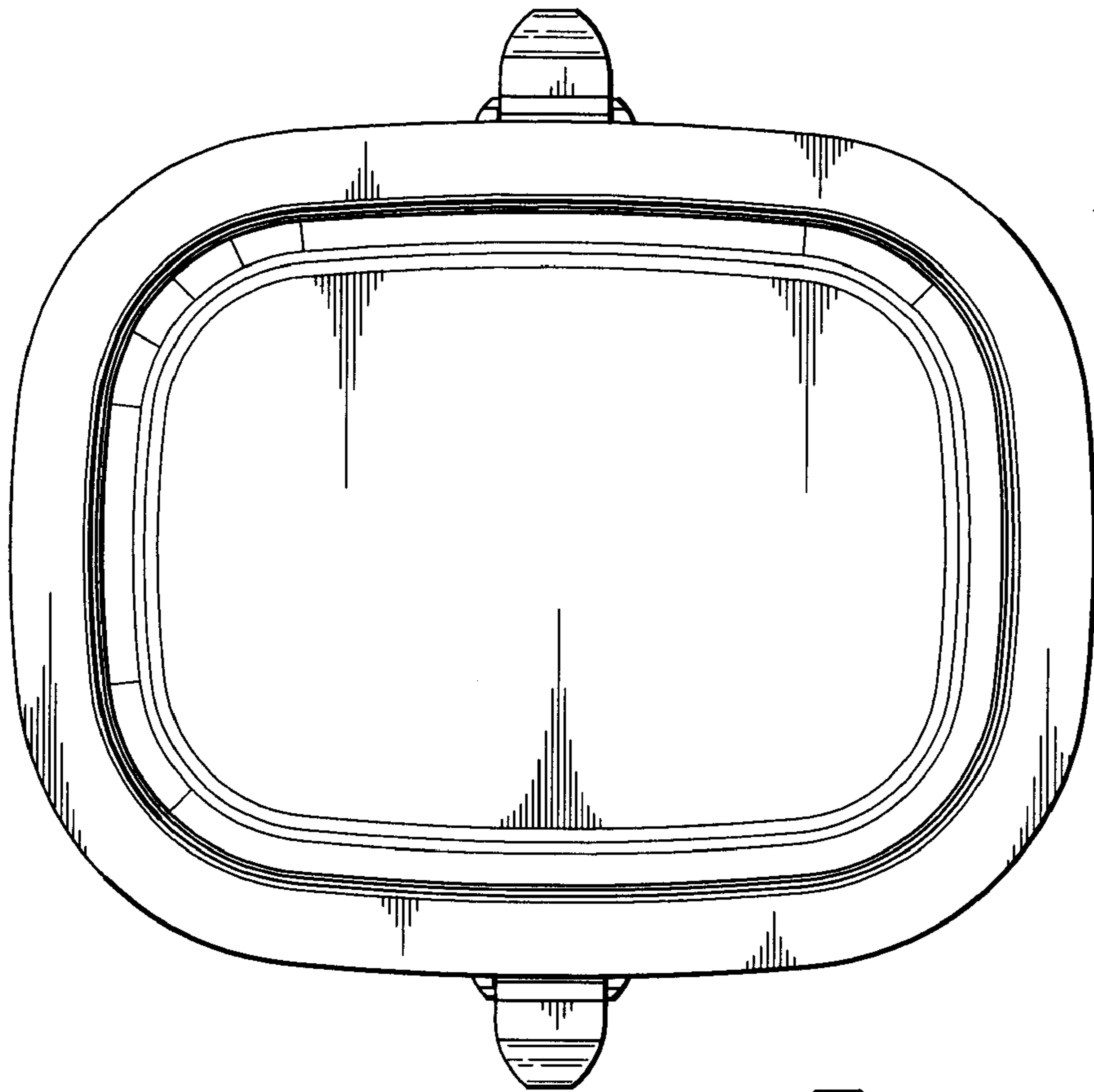


*Fig. 6*

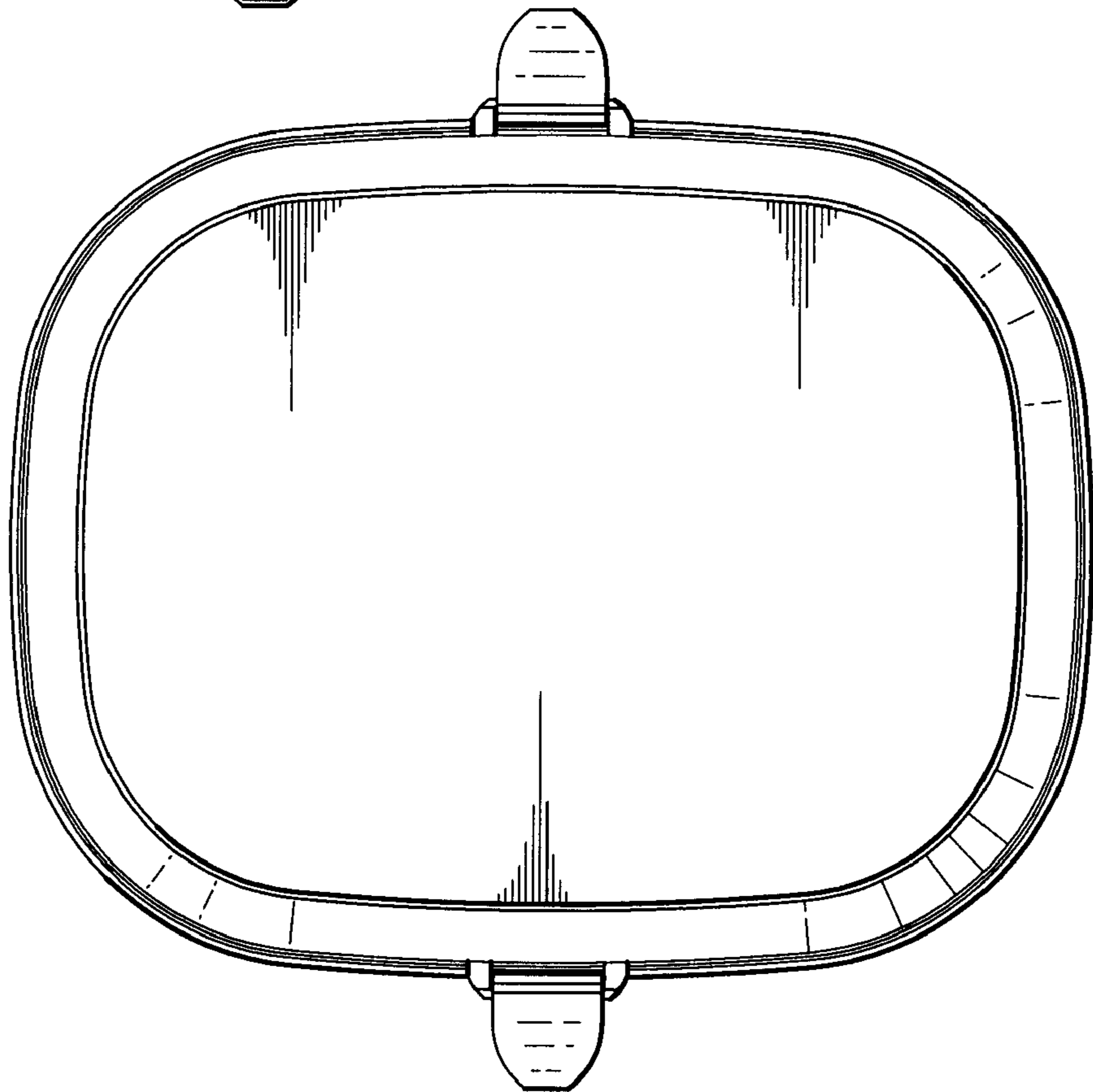


*Fig. 7*





*Fig. 8*



*Fig. 9*