

US00D527211S

(12) **United States Design Patent** (10) **Patent No.:** **US D527,211 S**
Harrold (45) **Date of Patent:** **** Aug. 29, 2006**

(54) **MOUNTBOARD FILING DRAWER**

Primary Examiner—Cathron C. Brooks
(74) *Attorney, Agent, or Firm*—Buchanan Ingersoll PC

(76) Inventor: **Martin Stephen Harrold**, 82 Careless Avenue, Harborne, Birmingham (GB), B17 9BW

(57) **CLAIM**

(**) Term: **14 Years**

The ornamental design for a mountboard filing drawer, as shown and described.

(21) Appl. No.: **29/210,859**

DESCRIPTION

(22) Filed: **Aug. 9, 2004**

(51) **LOC (8) Cl.** **06-06**

(52) **U.S. Cl.** **D6/510**

(58) **Field of Classification Search** D6/491, D6/509–511, 402, 481, 500; 312/330.1, 334.1, 312/228, 348.5, 334.24, 334.28

See application file for complete search history.

FIG. 1 is a rear, left side perspective view of a mountboard filing drawer showing a first embodiment of my new design.

FIG. 2 is further rear, left side perspective view thereof.

FIG. 3 is a front, right side perspective view thereof.

FIG. 4 is a right side elevational view thereof.

FIG. 5 is a bottom plan view thereof.

FIG. 6 is a left side elevational view thereof.

FIG. 7 is a rear elevational view thereof.

FIG. 8 is a front elevational view thereof.

FIG. 9 is a top plan view thereof.

FIG. 10 is a rear, left side perspective view of a mountboard filing drawer showing a second embodiment of my new design.

FIG. 11 is a front, right side perspective view thereof.

FIG. 12 is a bottom plan view thereof.

FIG. 13 is a top plan view thereof.

FIG. 14 is a rear elevational view thereof; and,

FIG. 15 is a front elevational view thereof.

(56) **References Cited**

U.S. PATENT DOCUMENTS

4,124,260	A	*	11/1978	Bergman	312/107
4,515,420	A	*	5/1985	Grosch	312/9.59
5,046,861	A	*	9/1991	Tarver	384/20
5,131,732	A	*	7/1992	Lane et al.	312/190
5,468,063	A	*	11/1995	Simonek	312/334.28
5,597,219	A	*	1/1997	Horn et al.	312/330.1
6,113,200	A	*	9/2000	Slivon	312/218
6,135,584	A	*	10/2000	Happ	312/330.1
6,199,966	B1	*	3/2001	Fulterer	312/334.24

* cited by examiner

1 Claim, 15 Drawing Sheets

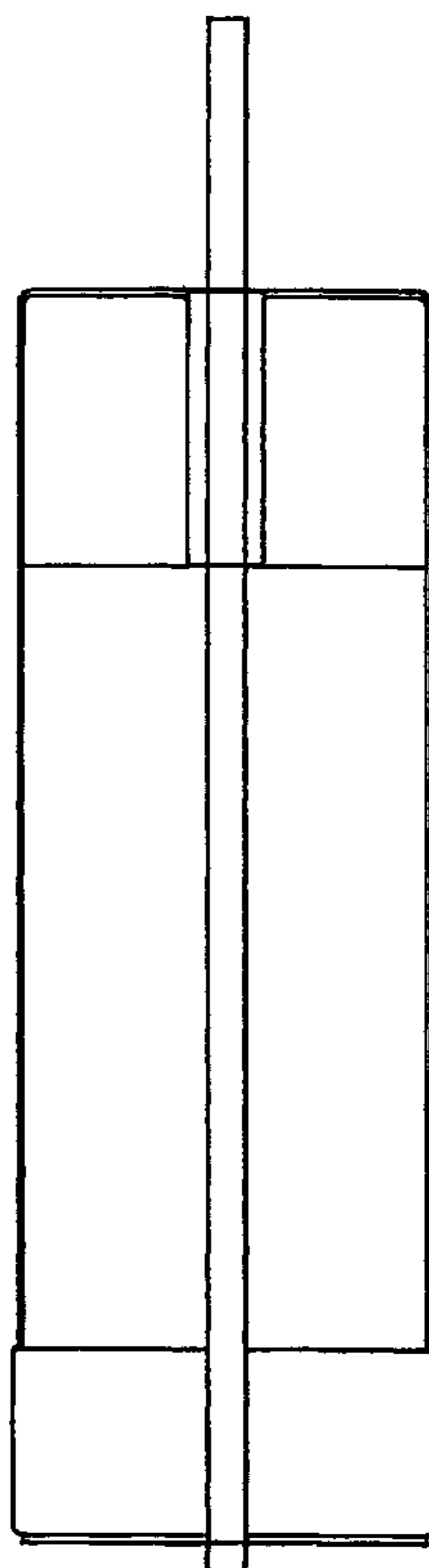

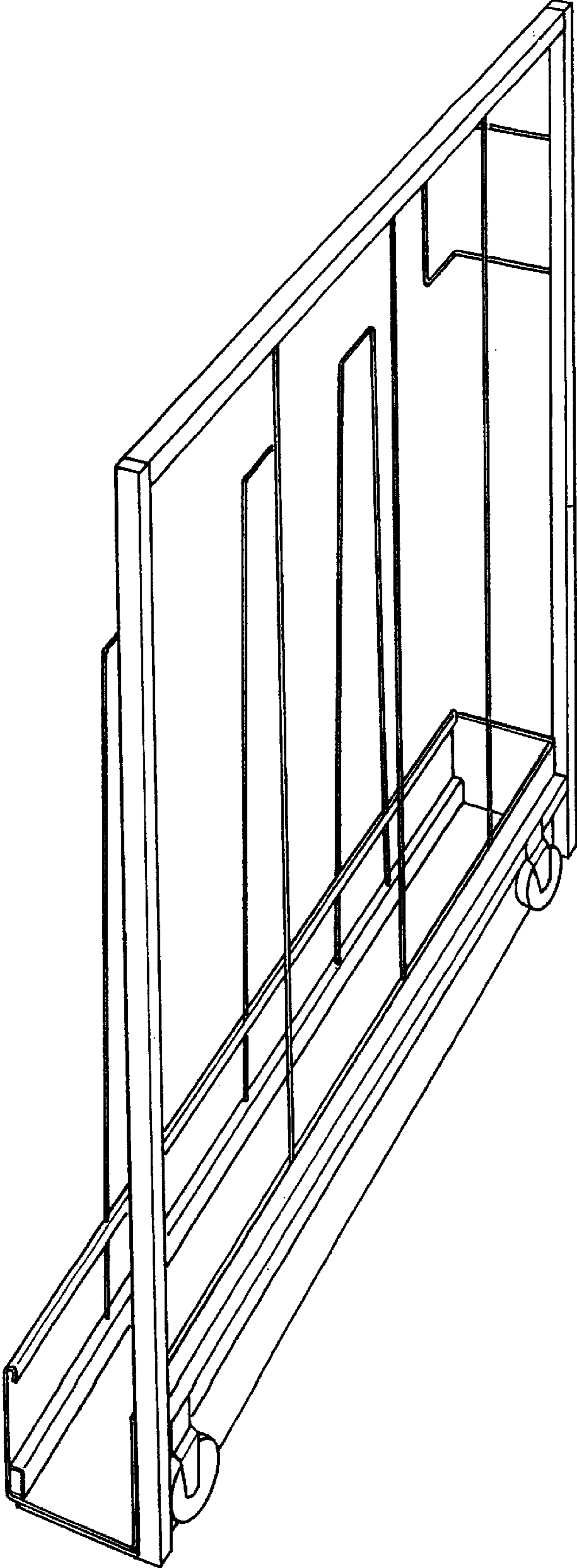

FIG. 1

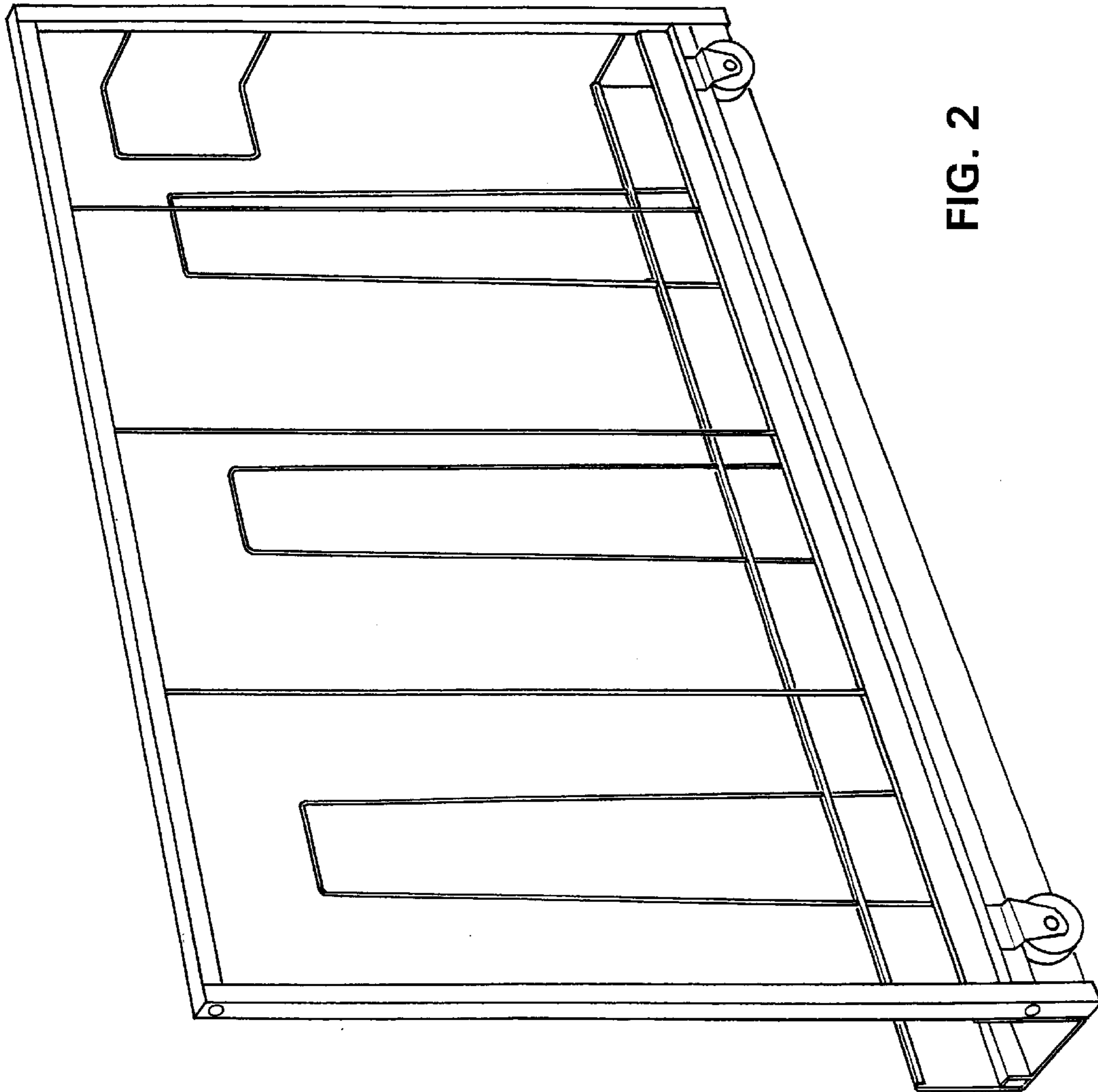

FIG. 2

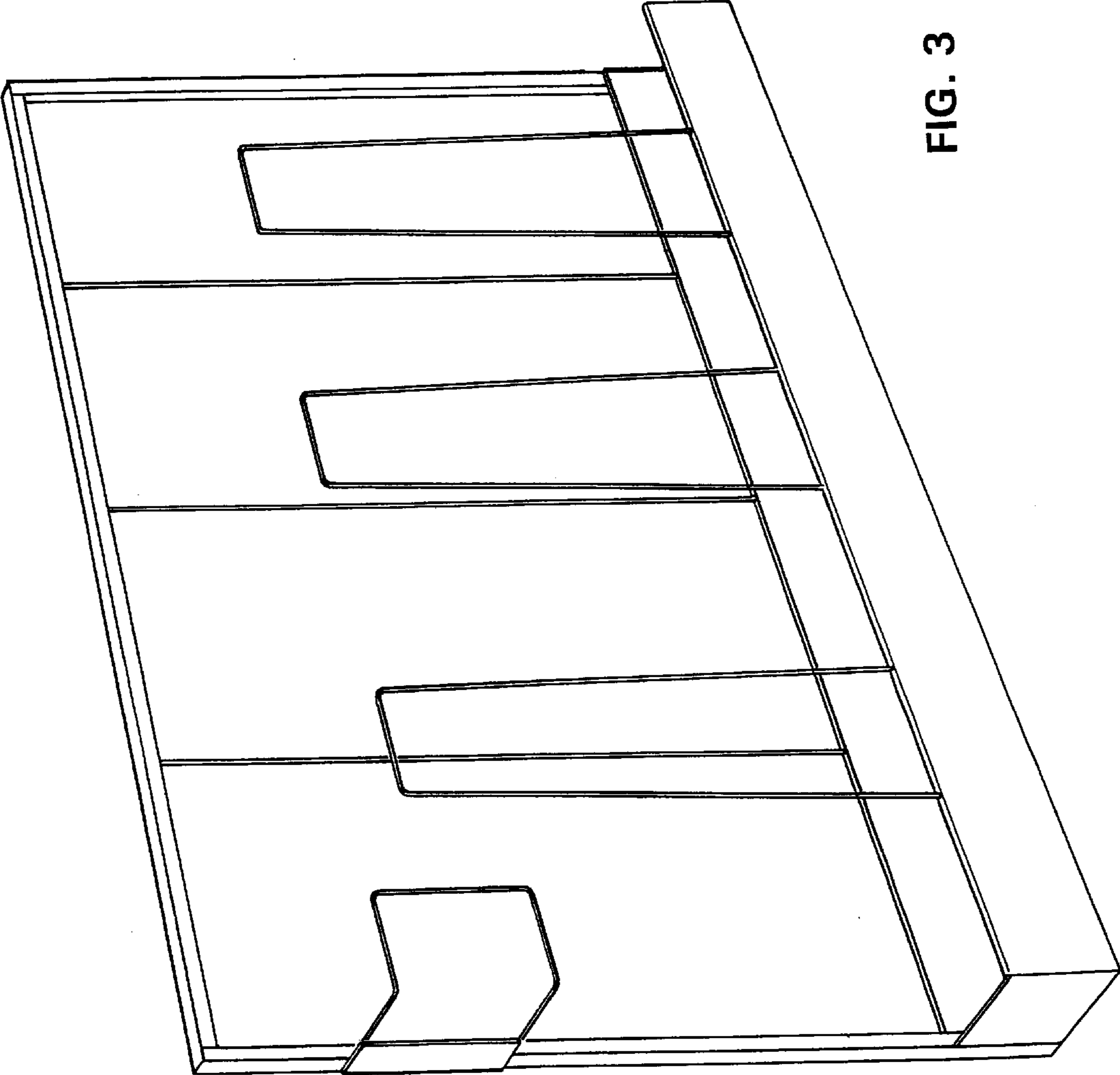

FIG. 3

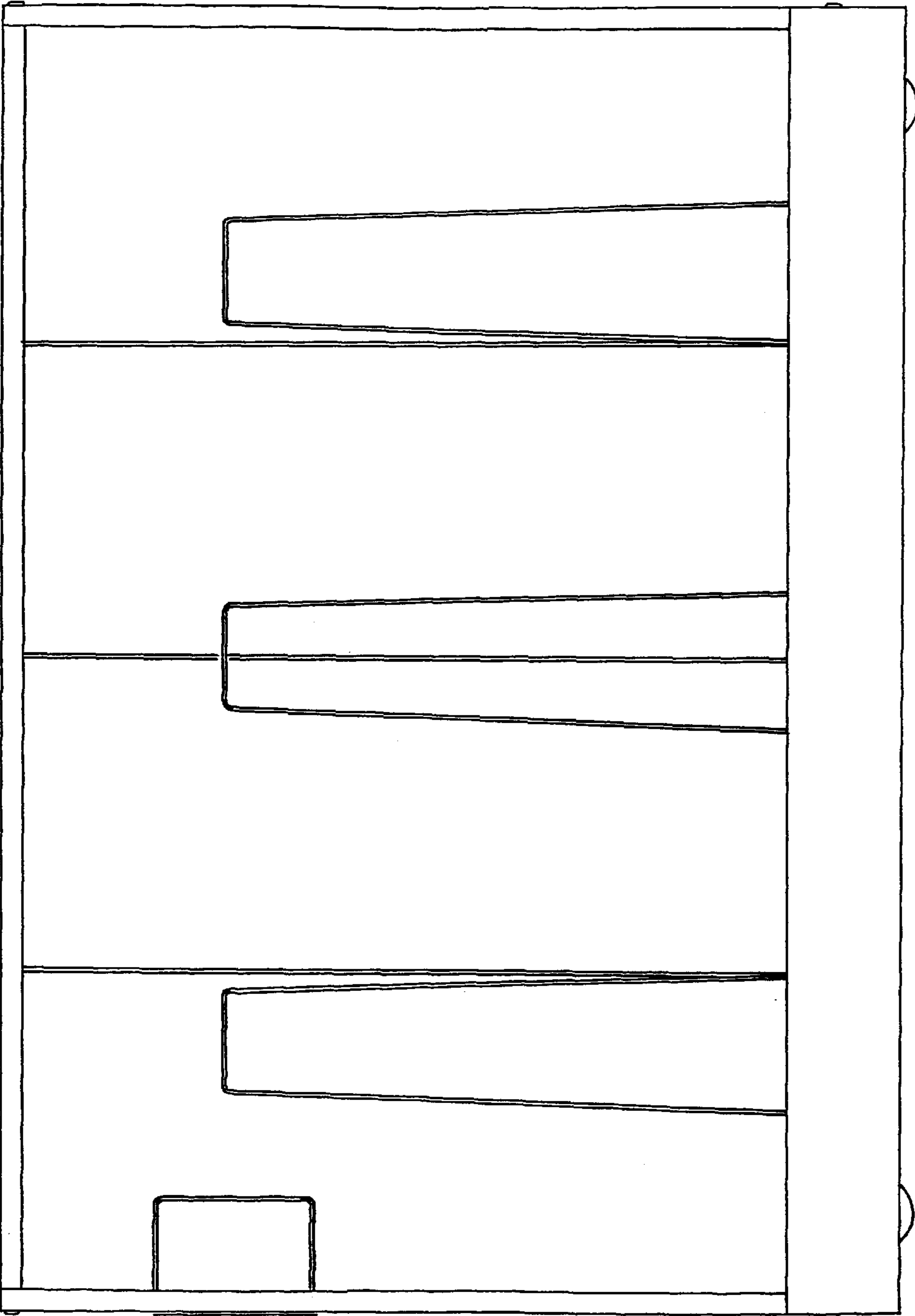

FIG. 4

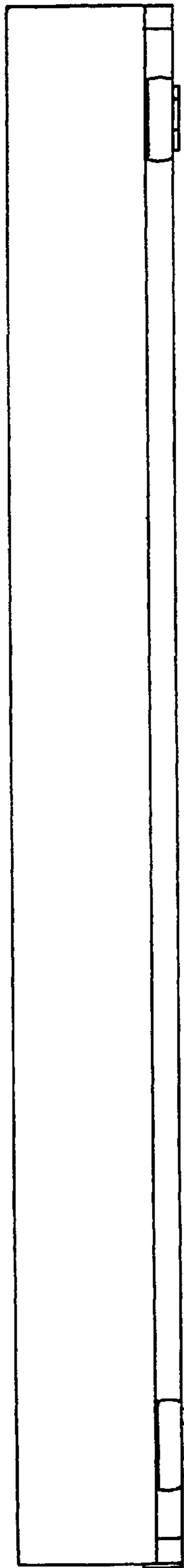

FIG. 5

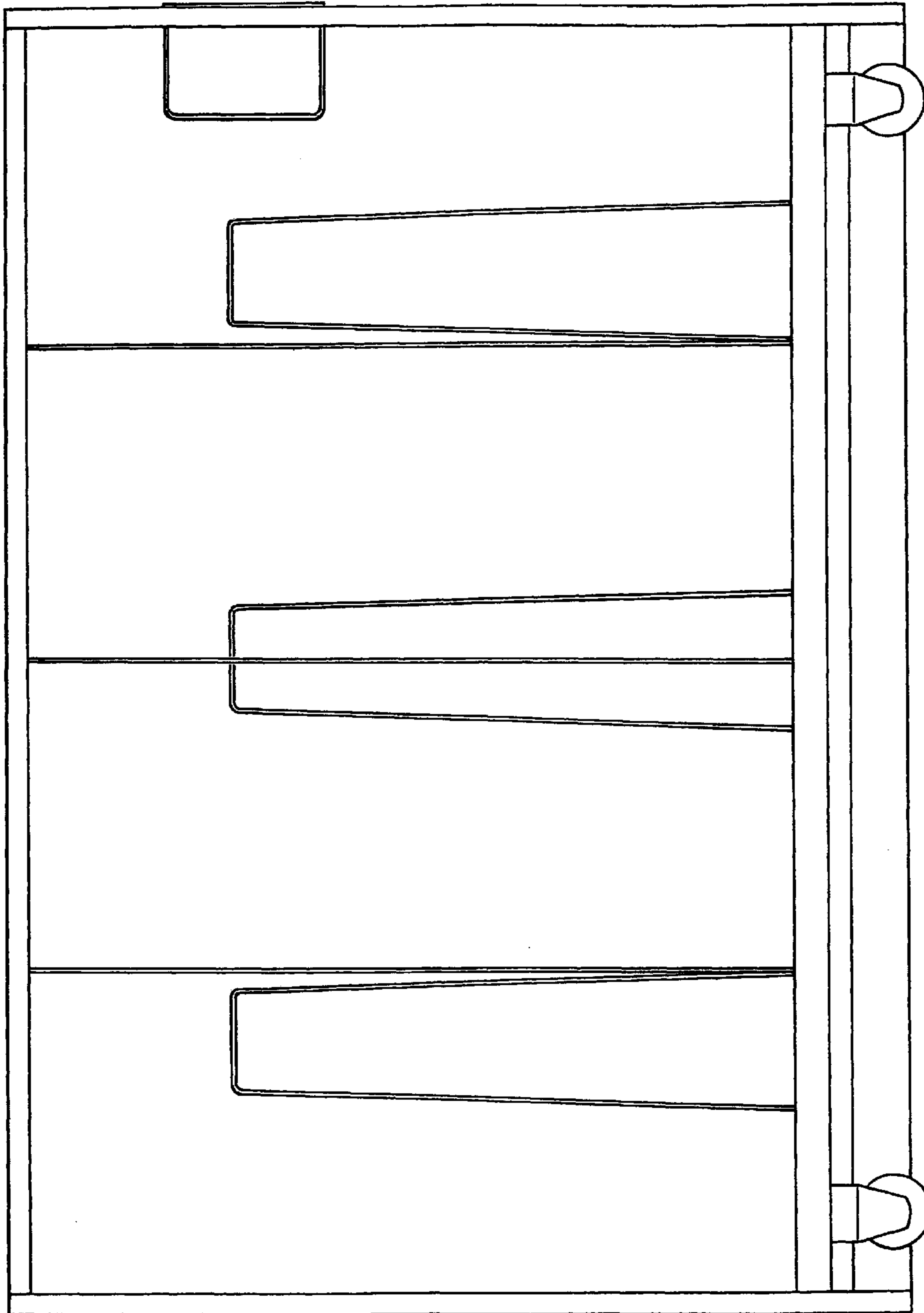

FIG. 6

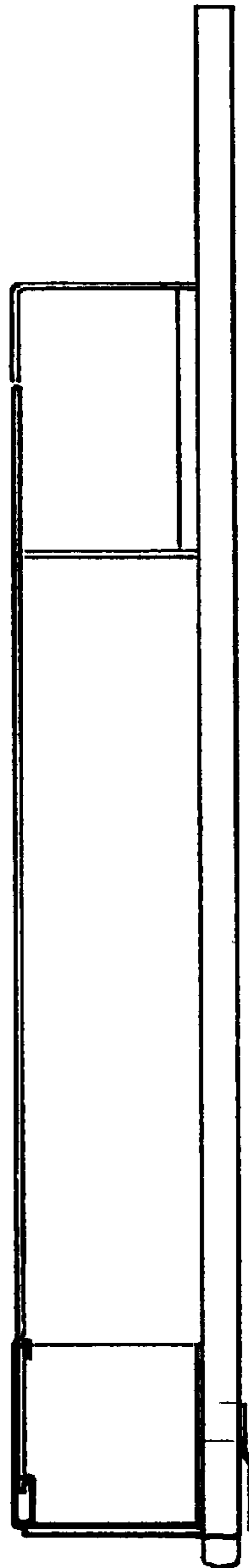
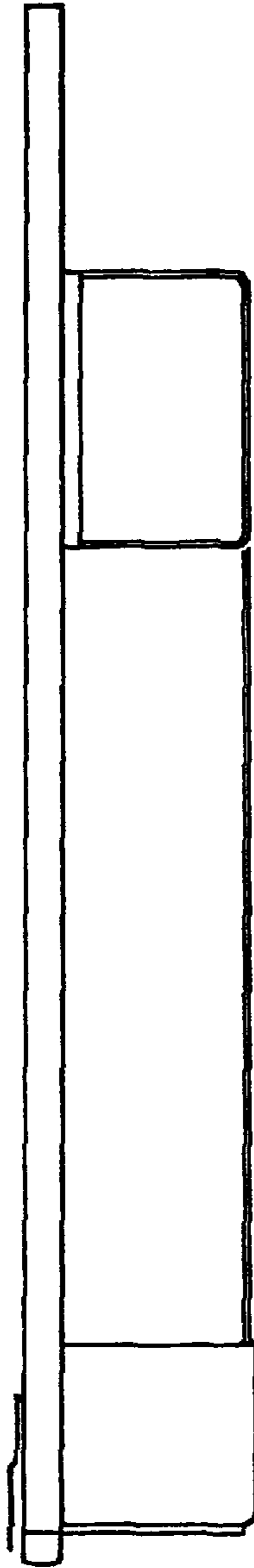

FIG. 7

FIG. 8



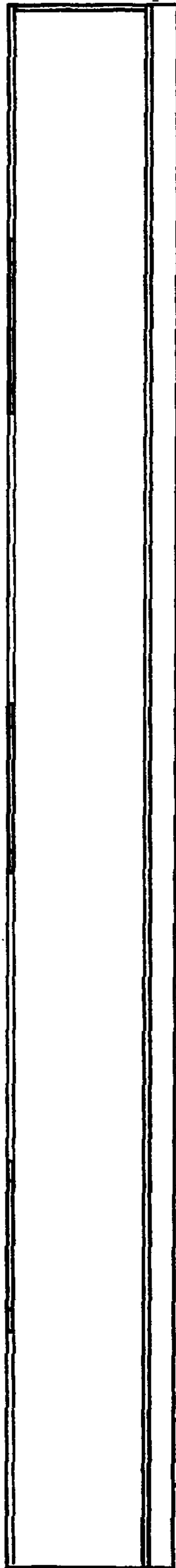

FIG. 9

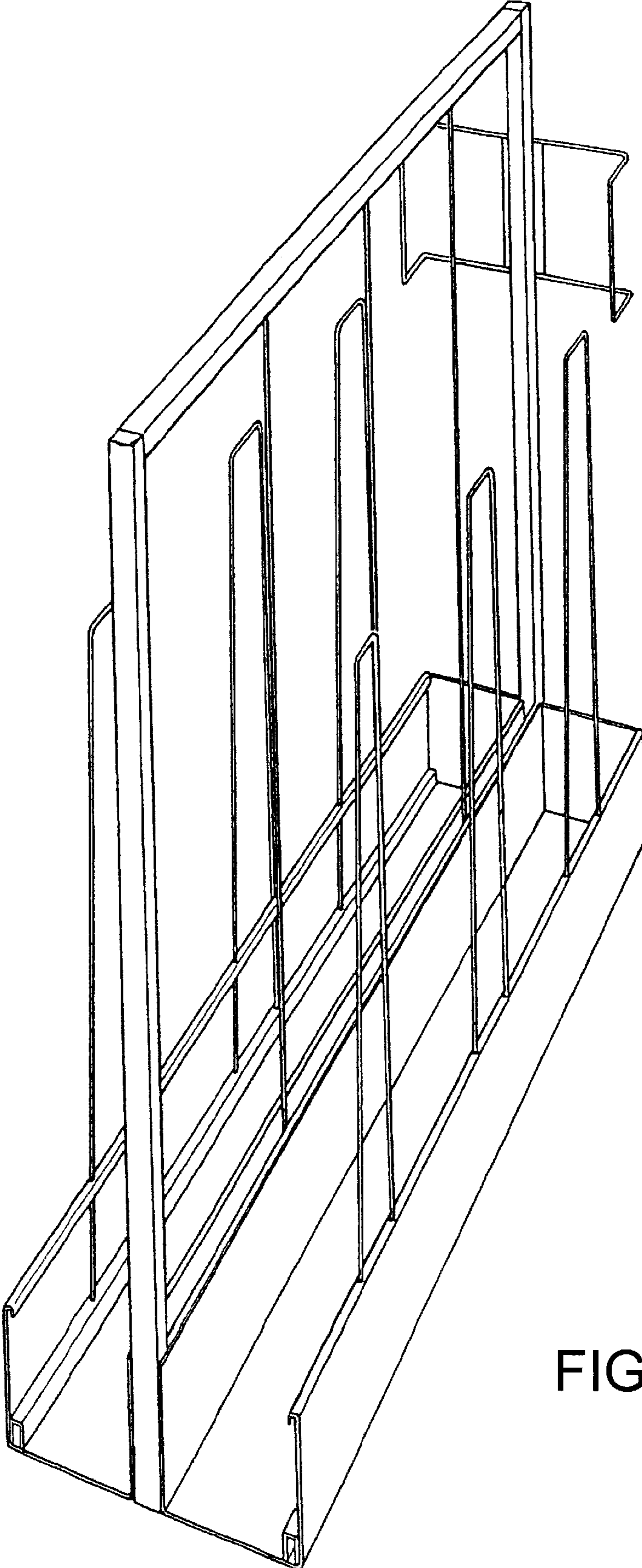

FIG. 10

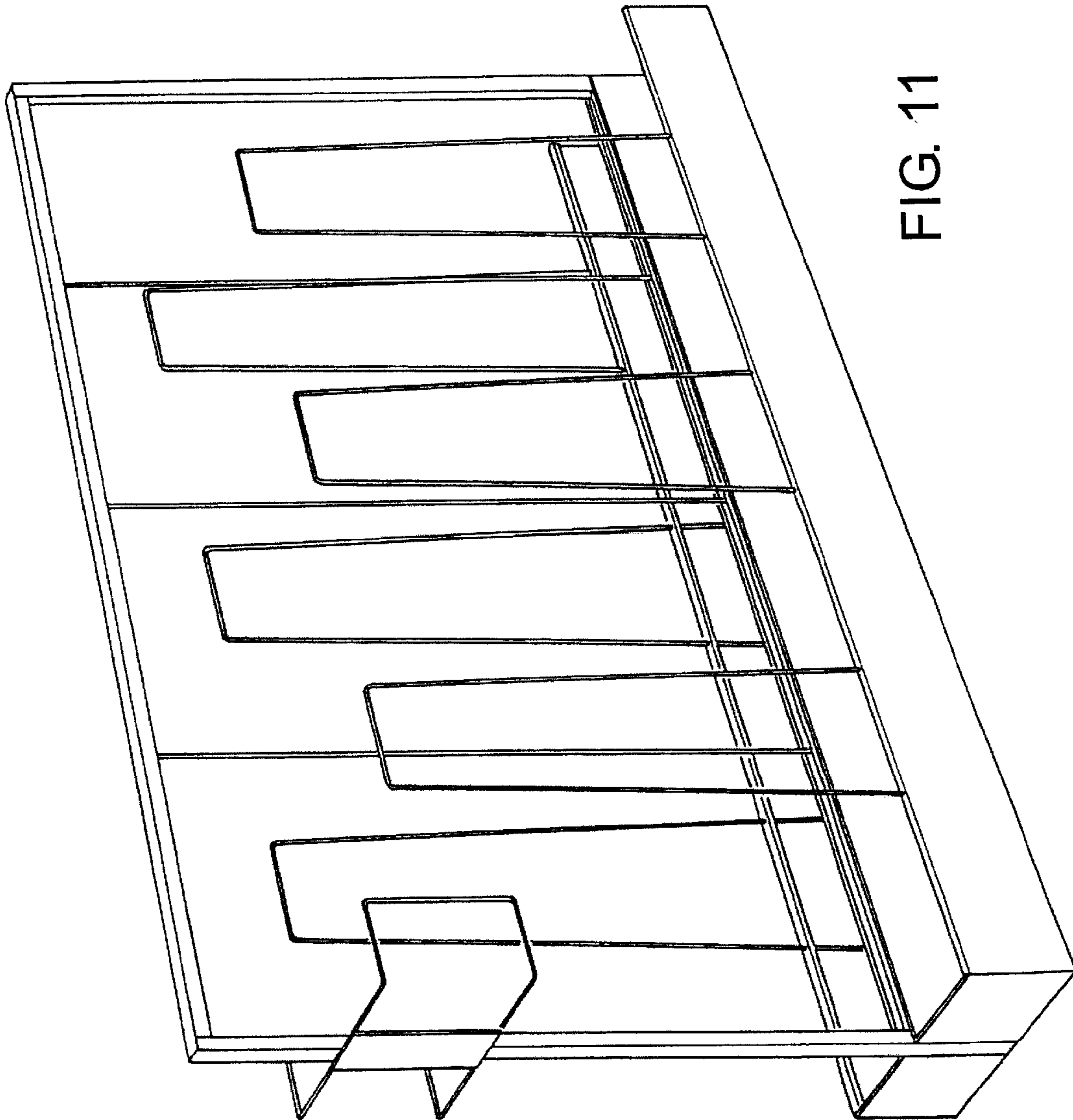
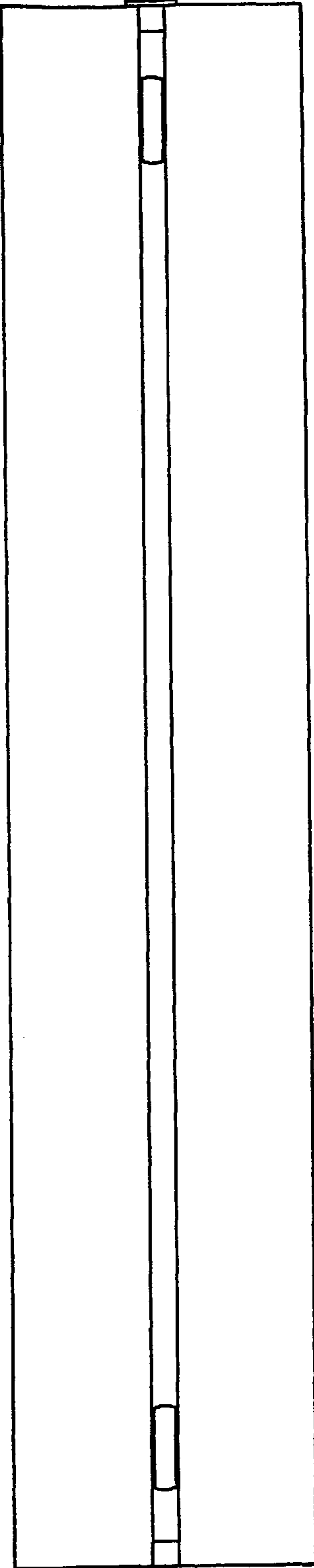

FIG. 11

FIG. 12



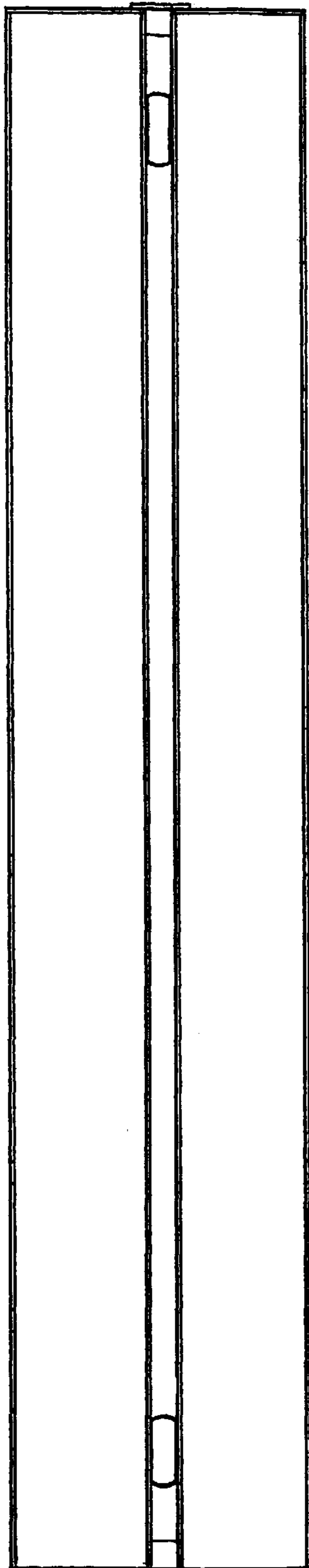

FIG. 13

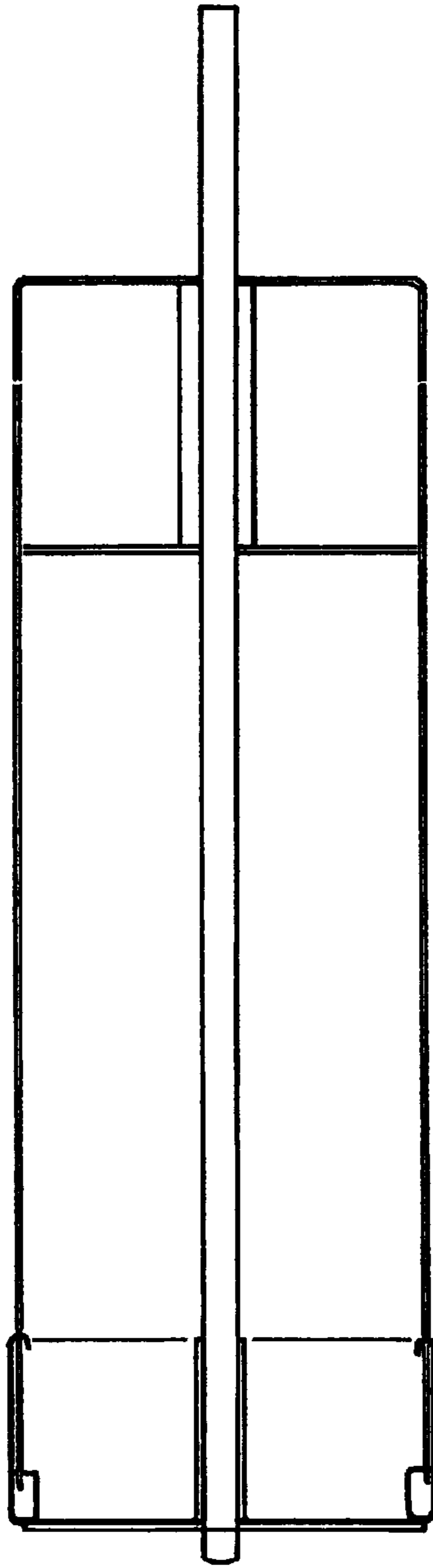

FIG. 14

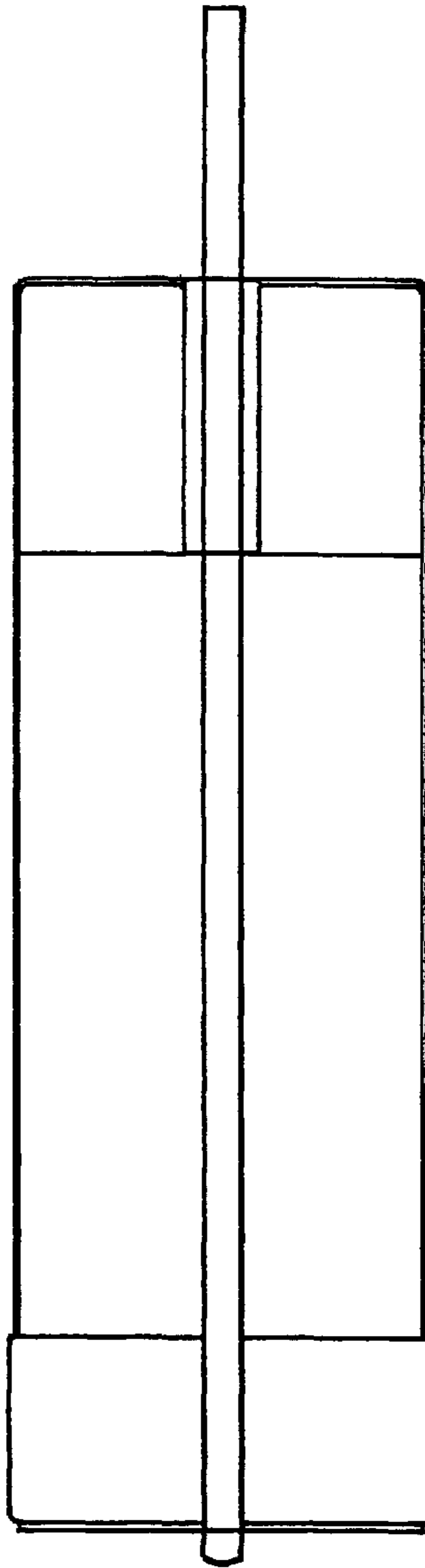

FIG. 15