



US00D527201S

(12) **United States Design Patent**  
**Nicoletti**

(10) **Patent No.:** **US D527,201 S**

(45) **Date of Patent:** **\*\* Aug. 29, 2006**

(54) **DESK**  
(75) **Inventor:** **Bruno Nicoletti**, Calderino di Monte S. Pietro (IT)

D392,475 S \* 3/1998 Kelly ..... D6/421  
6,170,410 B1 \* 1/2001 Gioacchini et al. .... 108/153.1  
6,196,140 B1 \* 3/2001 Newhouse et al. .... 108/50.02  
D492,504 S \* 7/2004 Gower ..... D6/421

(73) **Assignee:** **Metal Work Srl**, Bologna (IT)

\* cited by examiner

(\*\*) **Term:** **14 Years**

*Primary Examiner*—Janice E. Seeger

(74) *Attorney, Agent, or Firm*—William J. Sapone; Coleman Sudol Sapone P.C.

(21) **Appl. No.:** **29/210,661**

(22) **Filed:** **Aug. 4, 2004**

(57) **CLAIM**

I claim the design for a desk, as shown and described.

(51) **LOC (8) Cl.** ..... **06-03**

(52) **U.S. Cl.** ..... **D6/421; D6/480**

(58) **Field of Classification Search** ..... D6/421–428,  
D6/332; 312/194–196, 208.1, 208.2, 238,  
312/239; 108/50.01, 50.02, 60; 52/36.1, 239  
See application file for complete search history.

**DESCRIPTION**

FIG. 1 is a rear view of the desk, showing my new design;  
FIG. 2 is a bottom view of the desk;  
FIG. 3 is a front view the desk;  
FIG. 4 is a left side view of the desk;  
FIG. 5 is a right side view of the desk; and,  
FIG. 6 is a top view of the desk.

(56) **References Cited**

**U.S. PATENT DOCUMENTS**

D216,991 S \* 3/1970 Glanfagna ..... D6/421

**1 Claim, 6 Drawing Sheets**

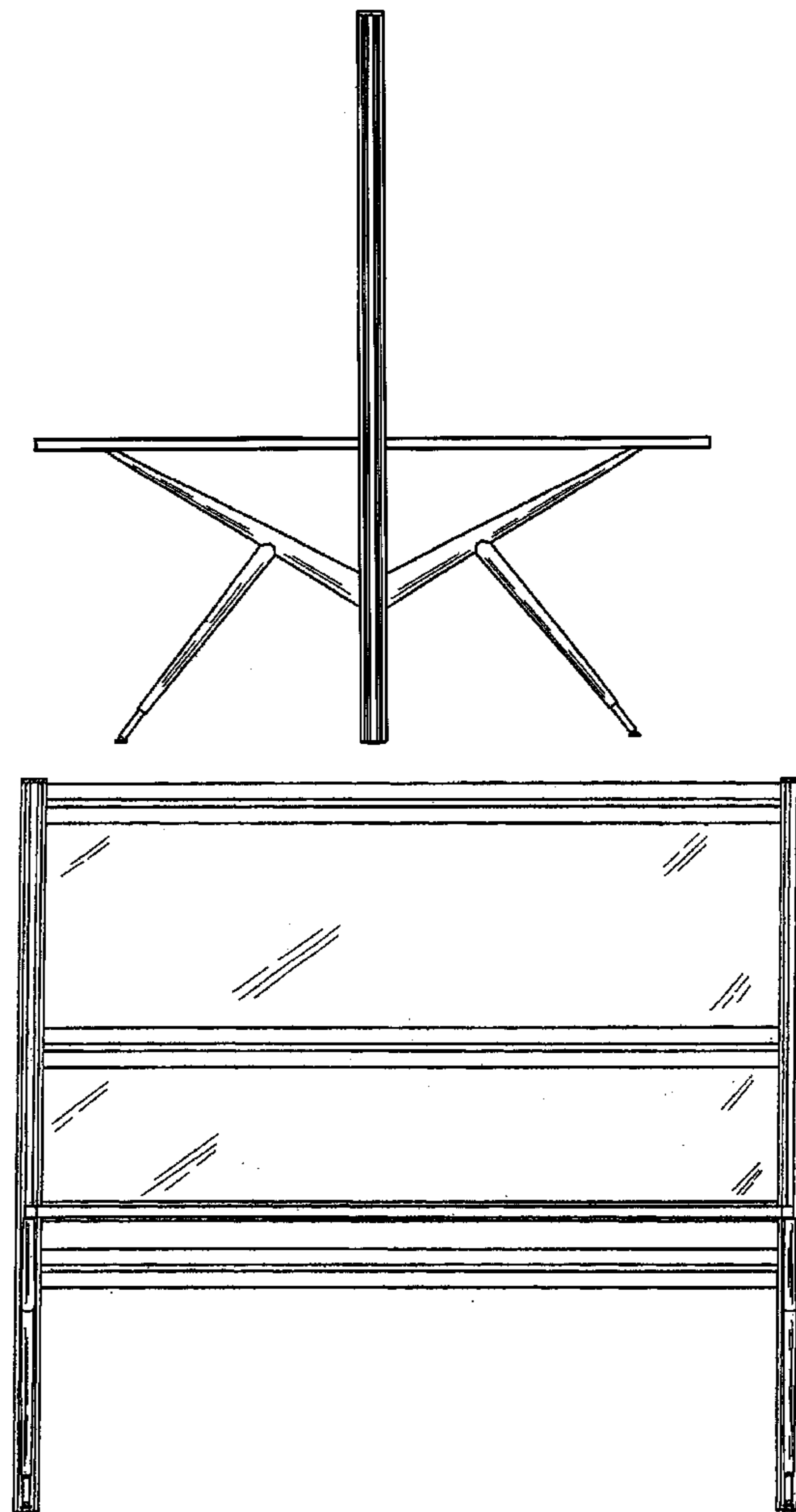

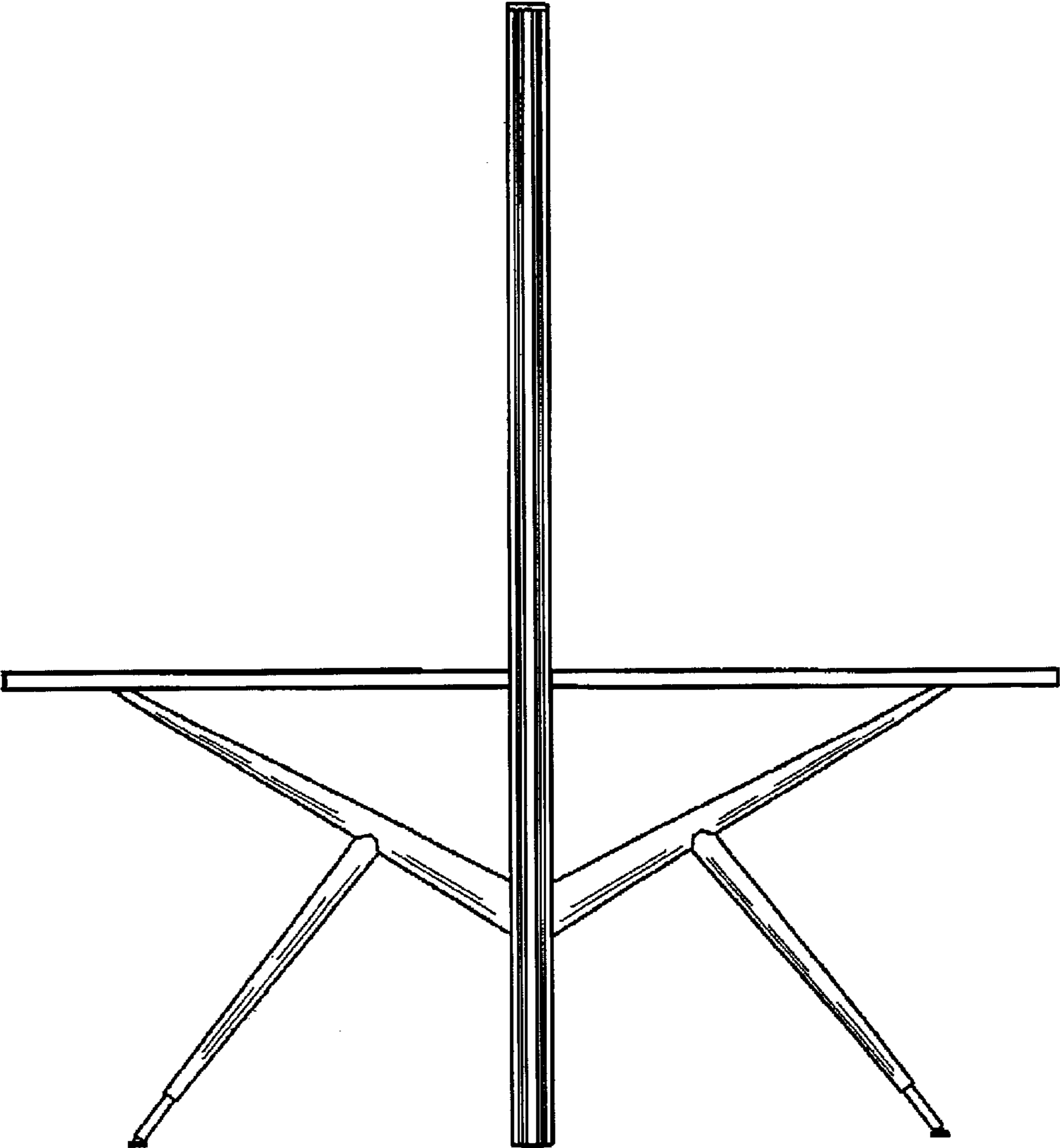

**FIG. 1**

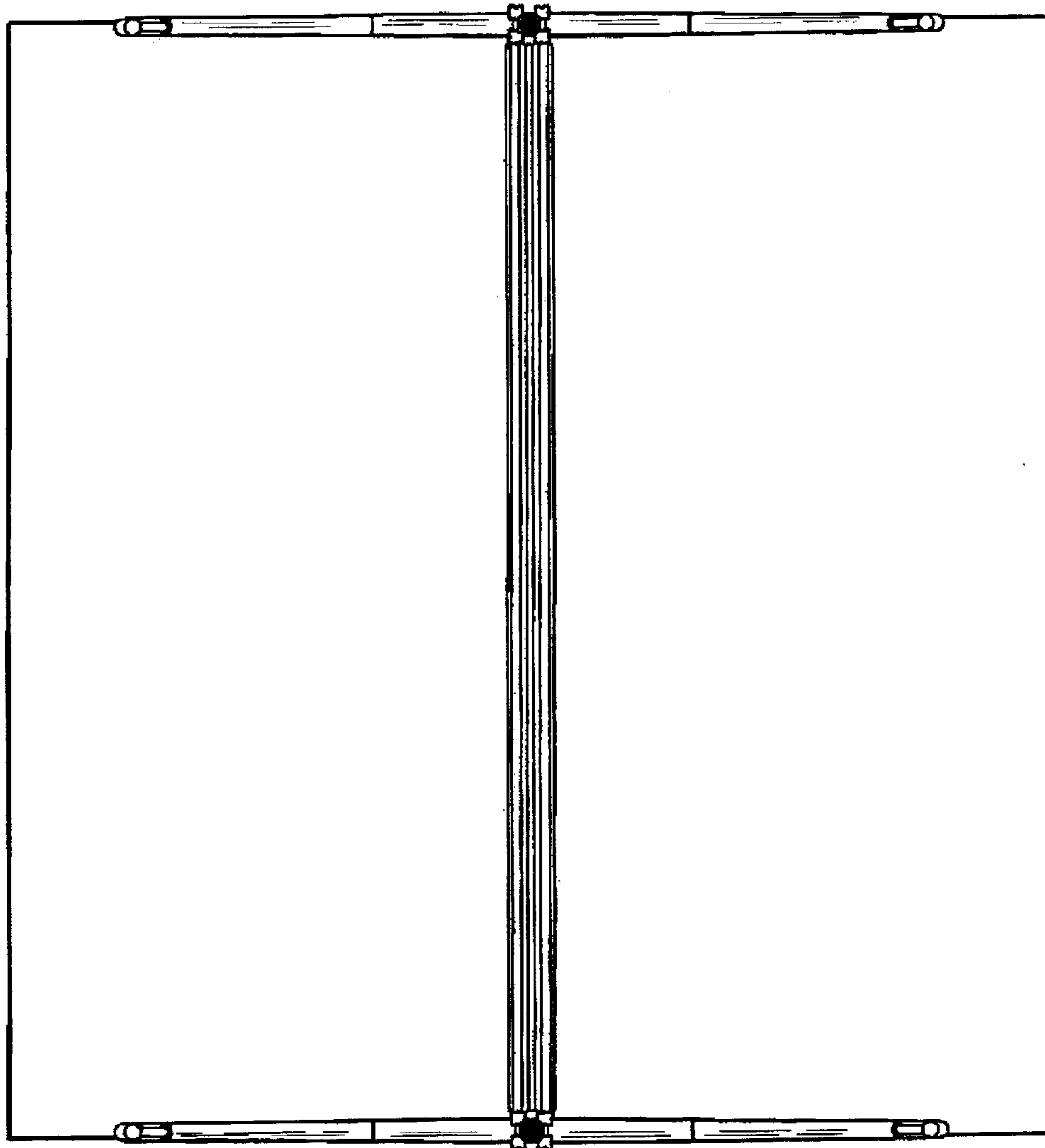

FIG. 2

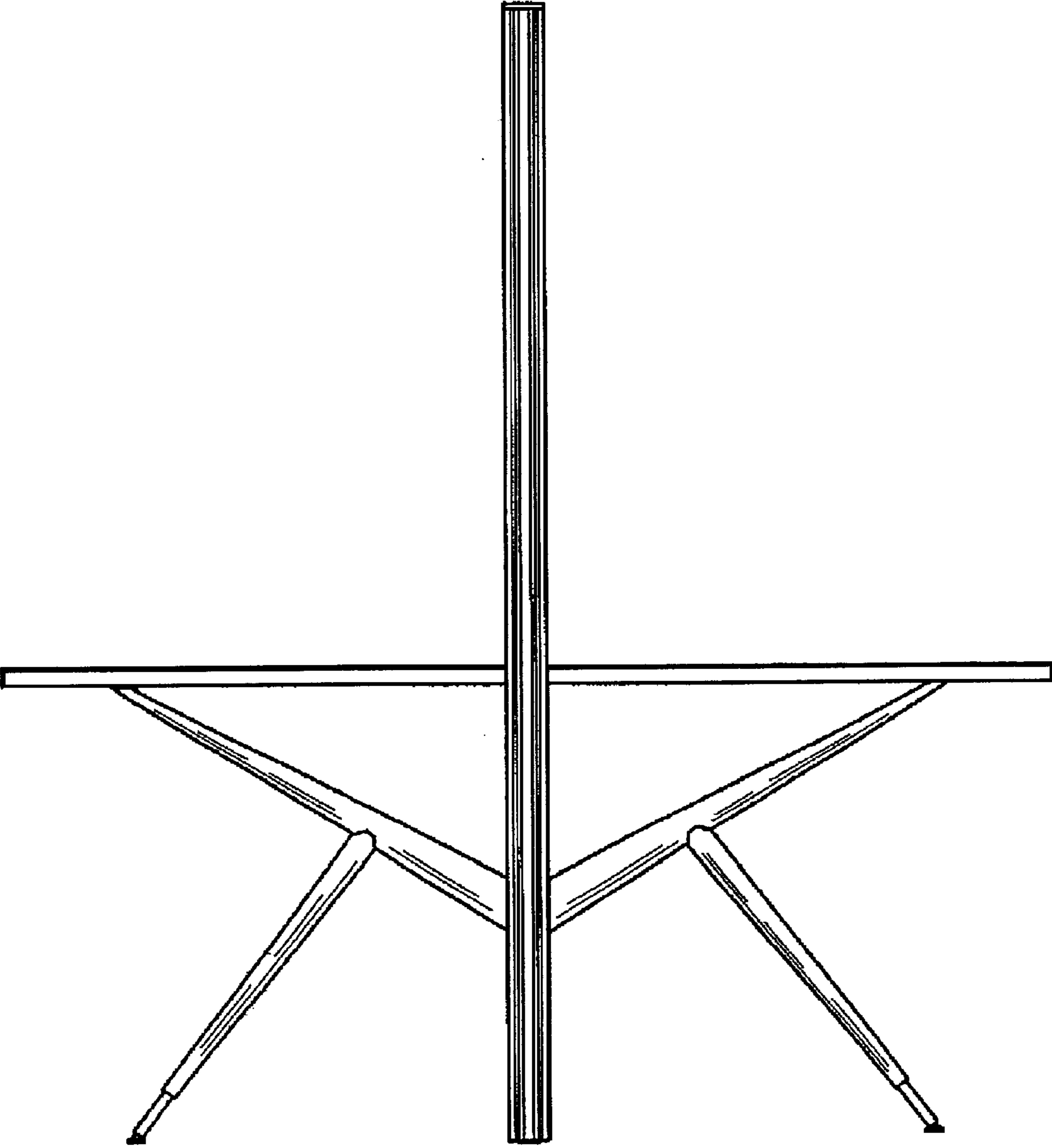

FIG. 3

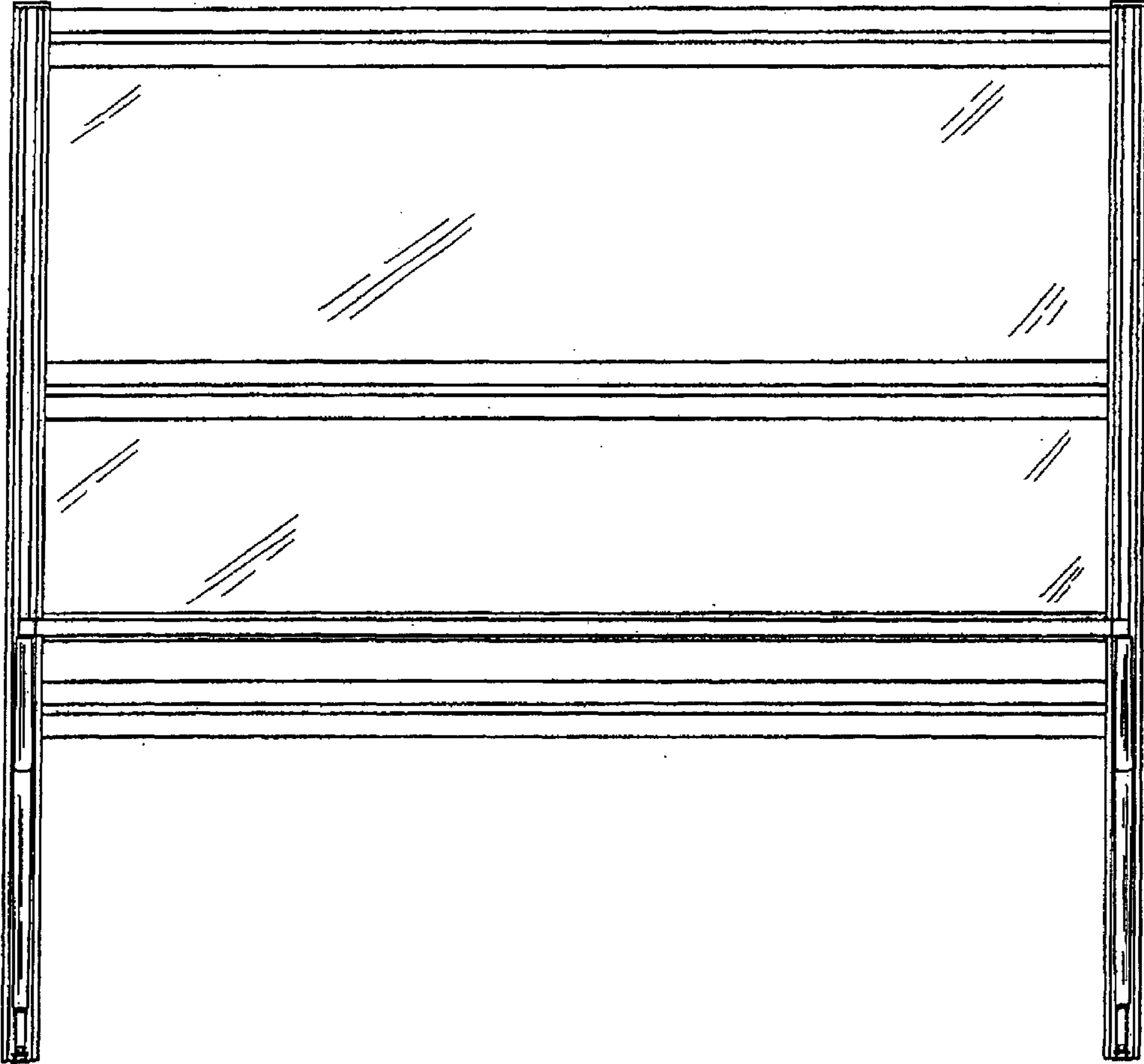

FIG. 4

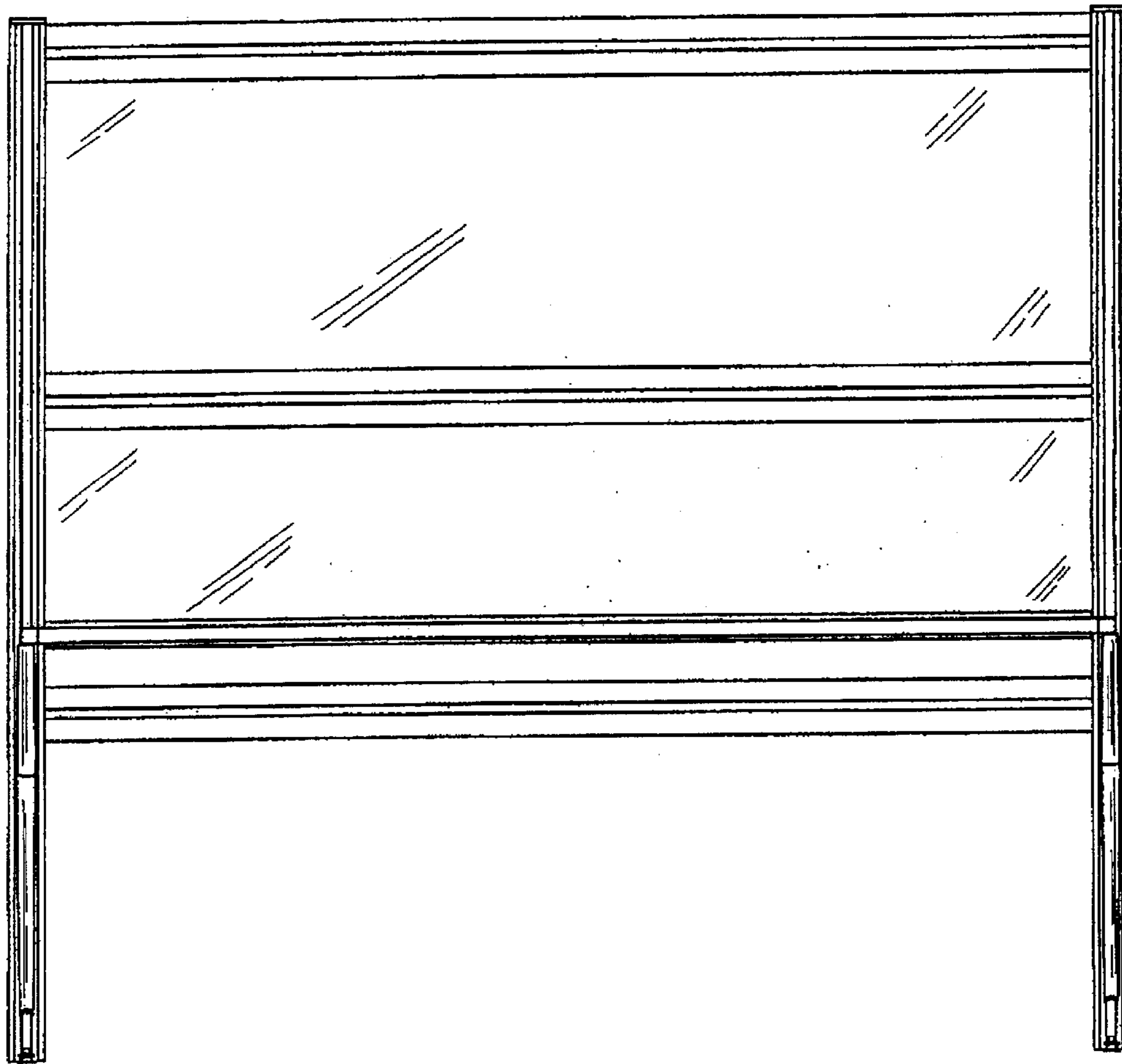

FIG. 5

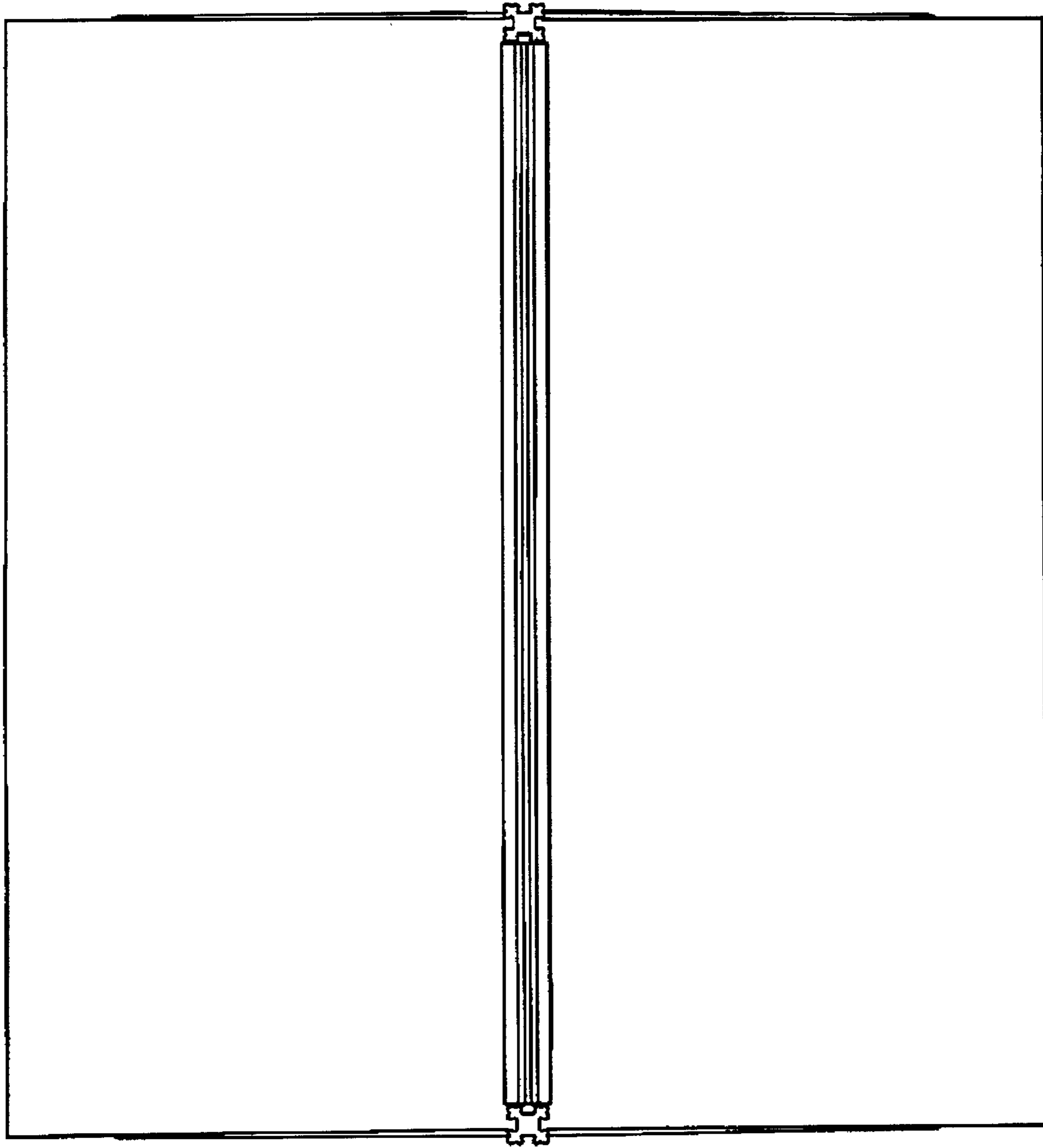

FIG. 6