

US00D527144S

(12) **United States Design Patent**
Crawford et al.

(10) **Patent No.:** **US D527,144 S**

(45) **Date of Patent:** **** Aug. 22, 2006**

(54) **MESSAGE SOAP BAR**
(75) Inventors: **John C. Crawford**, Mahopac, NY (US); **Camilo Bouzas**, Delegacion Miguel Hidalgo (MX); **Steven Johnson**, Basking Ridge, NJ (US); **Todd VanGordon**, Basking Ridge, NJ (US)

(73) Assignee: **Colgate-Palmolive Company**, New York, NY (US)

(**) Term: **14 Years**

(21) Appl. No.: **29/232,428**

(22) Filed: **Jun. 17, 2005**

(51) **LOC (8) Cl.** **28-02**

(52) **U.S. Cl.** **D28/8.1**

(58) **Field of Classification Search** 510/133, 510/141-148, 224, 294, 298, 440, 445-449; D24/211, 214, 215, 101-103; 606/135, 137; D28/8.1, 8.2

See application file for complete search history.

(56) **References Cited**

U.S. PATENT DOCUMENTS

D24,506 S	7/1895	Webb	
D27,556 S	8/1897	Webb	
680,052 A	8/1901	Lynch	
875,985 A	1/1908	Conery, Jr.	
945,495 A	1/1910	Dilg et al.	
D51,802 S	2/1918	Williams	
1,828,361 A	10/1931	Crary et al.	
1,913,462 A	* 6/1933	Timar	601/135
2,007,107 A	7/1935	Bottrill	
2,011,129 A	8/1935	Voorhis	
D110,971 S	8/1938	Lewis	
D115,017 S	5/1939	Babbitt	
2,250,318 A	7/1941	Wallace, Jr.	
D131,278 S	2/1942	Voorhis	
2,420,734 A	5/1947	Churchill	
D147,438 S	9/1947	Frederics	
D154,766 S	8/1949	Gerhart	

2,505,444 A	4/1950	Verbsky	
D186,200 S	9/1959	Oppenheimer et al.	
D202,006 S	8/1965	Slippian	
D206,036 S	10/1966	Meeker	
D206,140 S	11/1966	Meeker	
D209,798 S	1/1968	Zeitvogel et al.	
D213,074 S	12/1968	Griffith et al.	
D245,856 S	* 9/1977	Grube	D24/211
D248,421 S	7/1978	Berman	
D262,663 S	1/1982	Neu et al.	
D262,908 S	2/1982	Pesco	
D269,376 S	6/1983	Nakao et al.	
D269,914 S	* 7/1983	Otsuka	D28/8.1
4,463,485 A	* 8/1984	Gueret	601/137
D280,664 S	9/1985	Ishida	
D298,063 S	10/1988	Bussell	

(Continued)

Primary Examiner—Jennifer Rivard

(74) *Attorney, Agent, or Firm*—Harris A. Wolin

(57) **CLAIM**

The ornamental design for a massage soap bar, as shown and described.

DESCRIPTION

FIG. 1 is a perspective view of the massage soap bar of our design in an inverted orientation;
 FIG. 2 is a top plan view thereof.
 FIG. 3 is a bottom plan view thereof.
 FIG. 4 is a front elevation view thereof.
 FIG. 5 is a rear elevation view thereof.
 FIG. 6 is a right side elevational view thereof.
 FIG. 7 is a left side view thereof.
 FIG. 8 is a perspective view of an alternate embodiment of the massage soap bar of FIG. 1.
 FIG. 9 is a top plan view thereof.
 FIG. 10 is a bottom plan view thereof.
 FIG. 11 is a front elevation view thereof.
 FIG. 12 is a rear elevation view thereof.
 FIG. 13 is a right side elevation view thereof; and,
 FIG. 14 is a left side elevation view thereof.

1 Claim, 8 Drawing Sheets

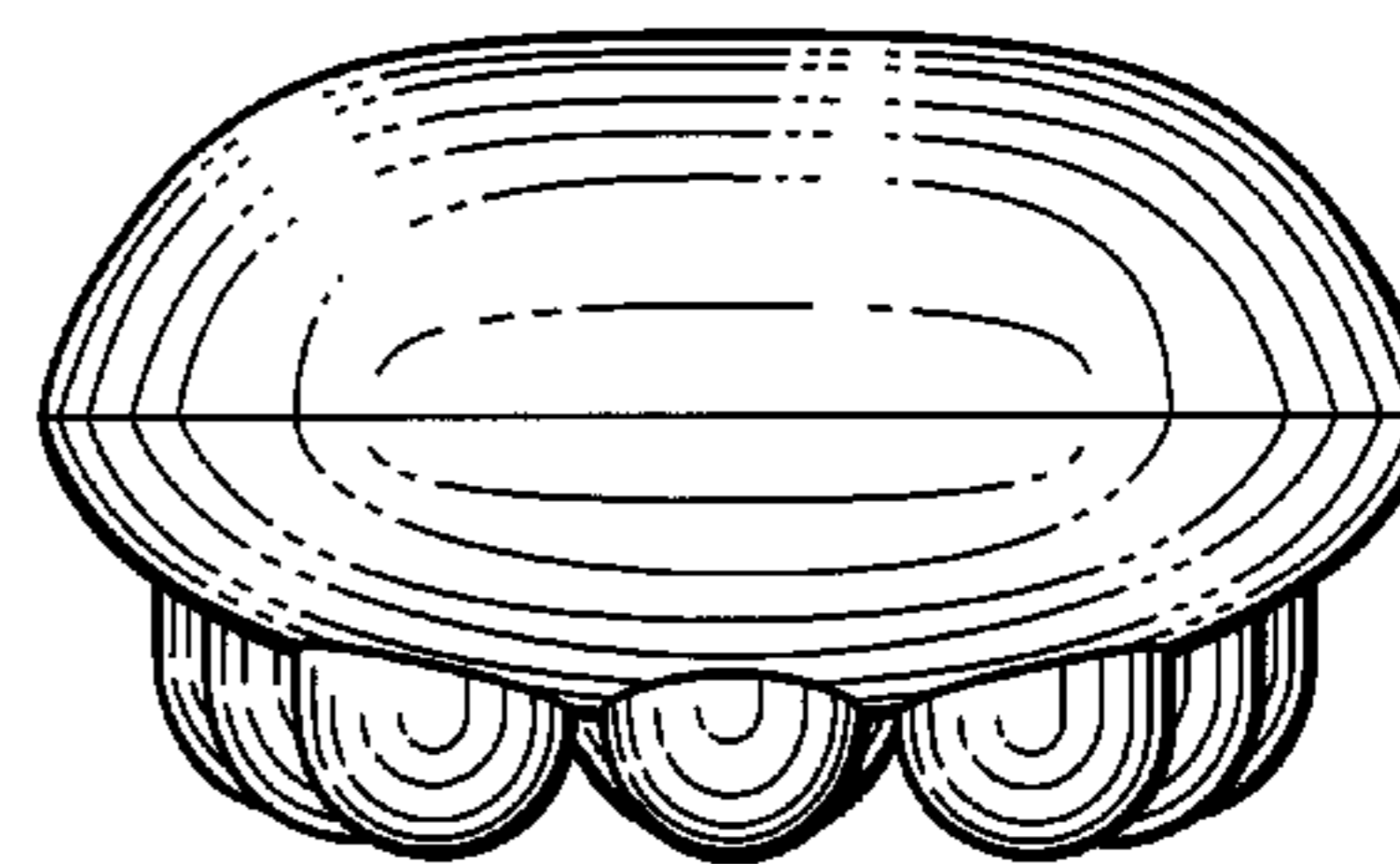
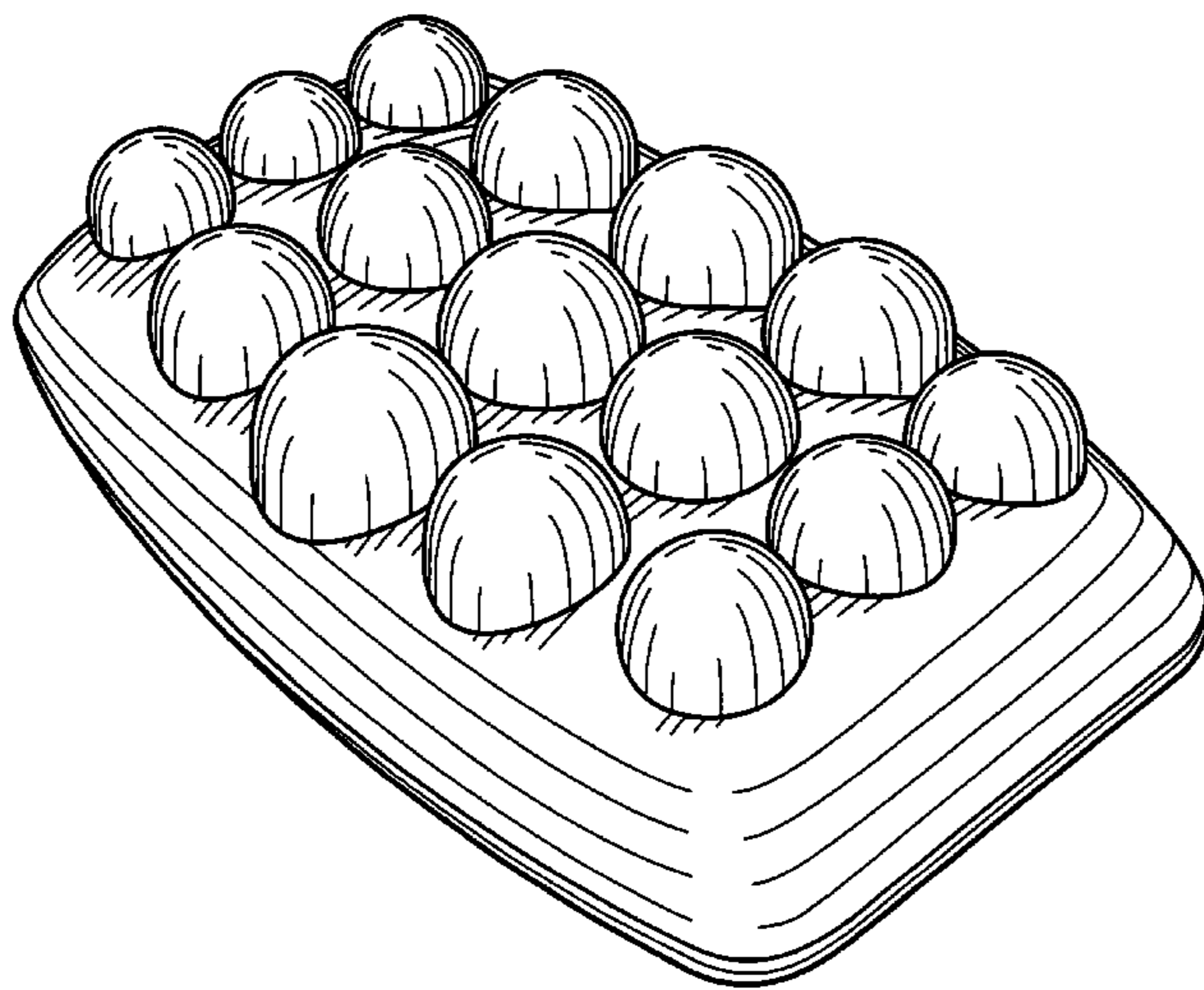

US D527,144 S

Page 2

U.S. PATENT DOCUMENTS

D298,065 S	10/1988	Bussell	D361,133 S	*	8/1995	Robertson et al.	D24/211
D299,277 S	1/1989	Bussell	D377,394 S	*	1/1997	Tillman et al.	D24/215
4,996,000 A	2/1991	Redeker	D387,482 S		12/1997	Khan	
5,198,140 A	3/1993	Joshi et al.	5,834,410 A		11/1998	Slocum	
D341,426 S	11/1993	Hubbard	D485,010 S	*	1/2004	Crawford	D28/8.1
D346,449 S	4/1994	Cheng	D490,530 S	*	5/2004	Chen	D24/211
D358,231 S	5/1995	Liu					

* cited by examiner

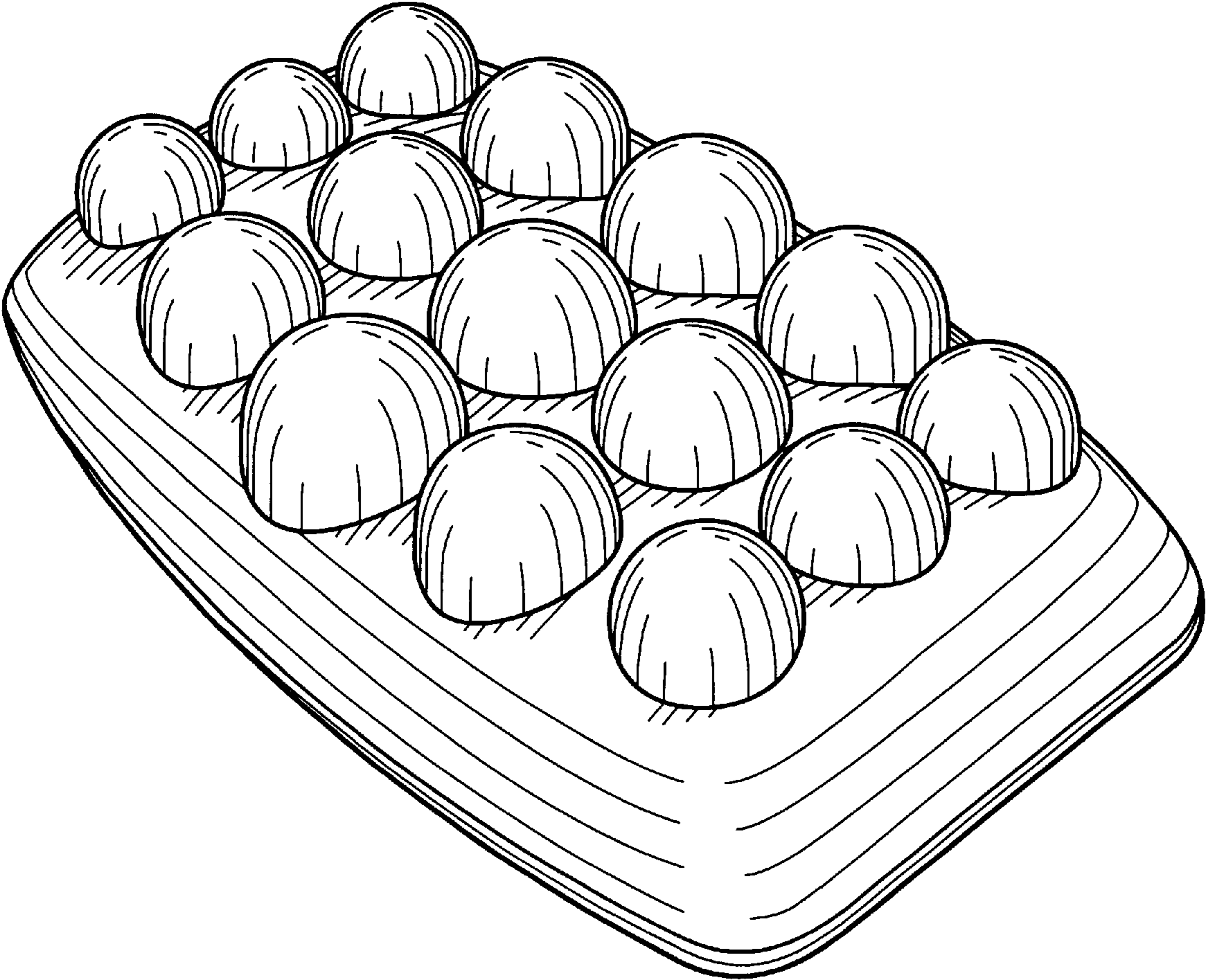

Fig. 1

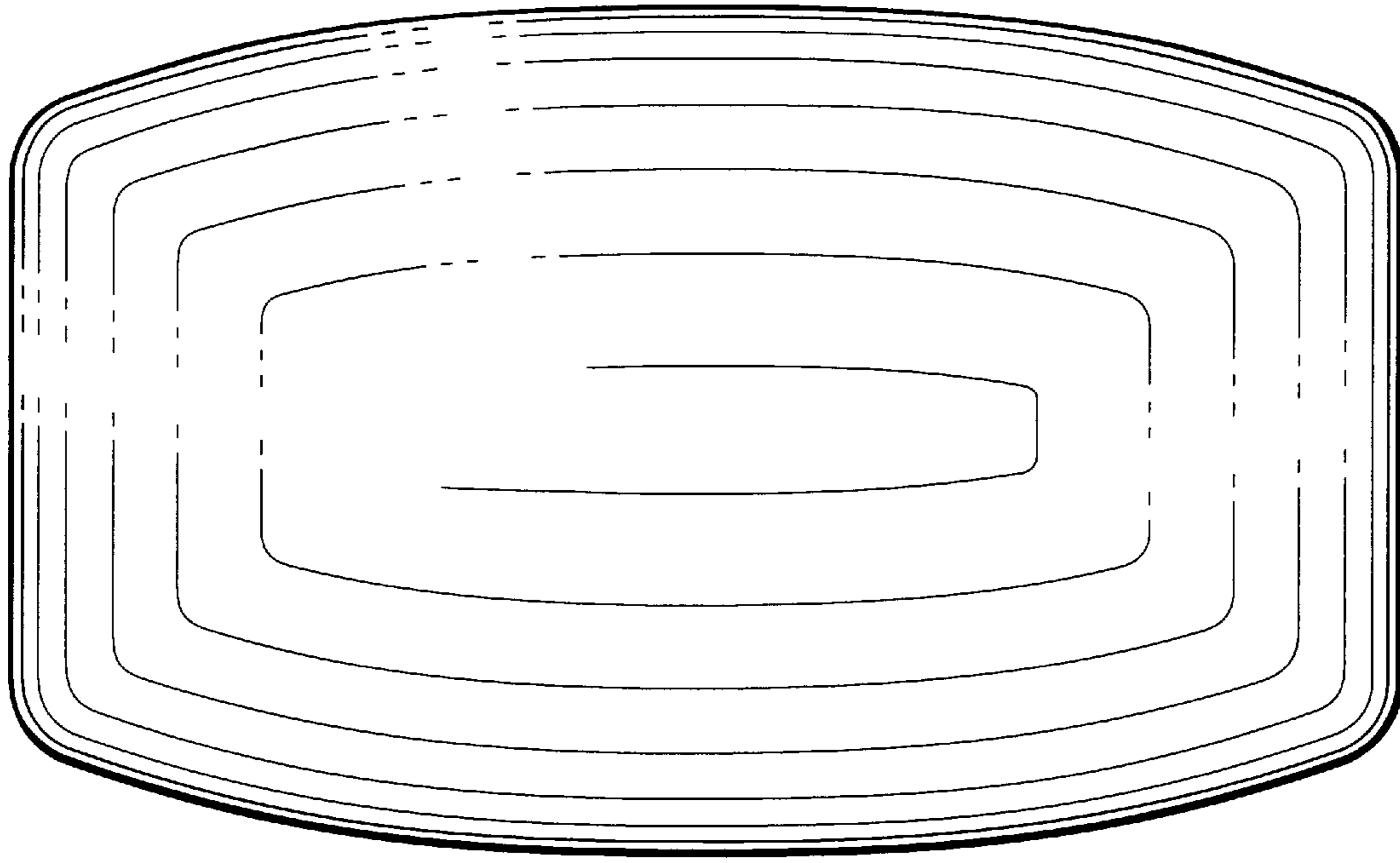

Fig. 2

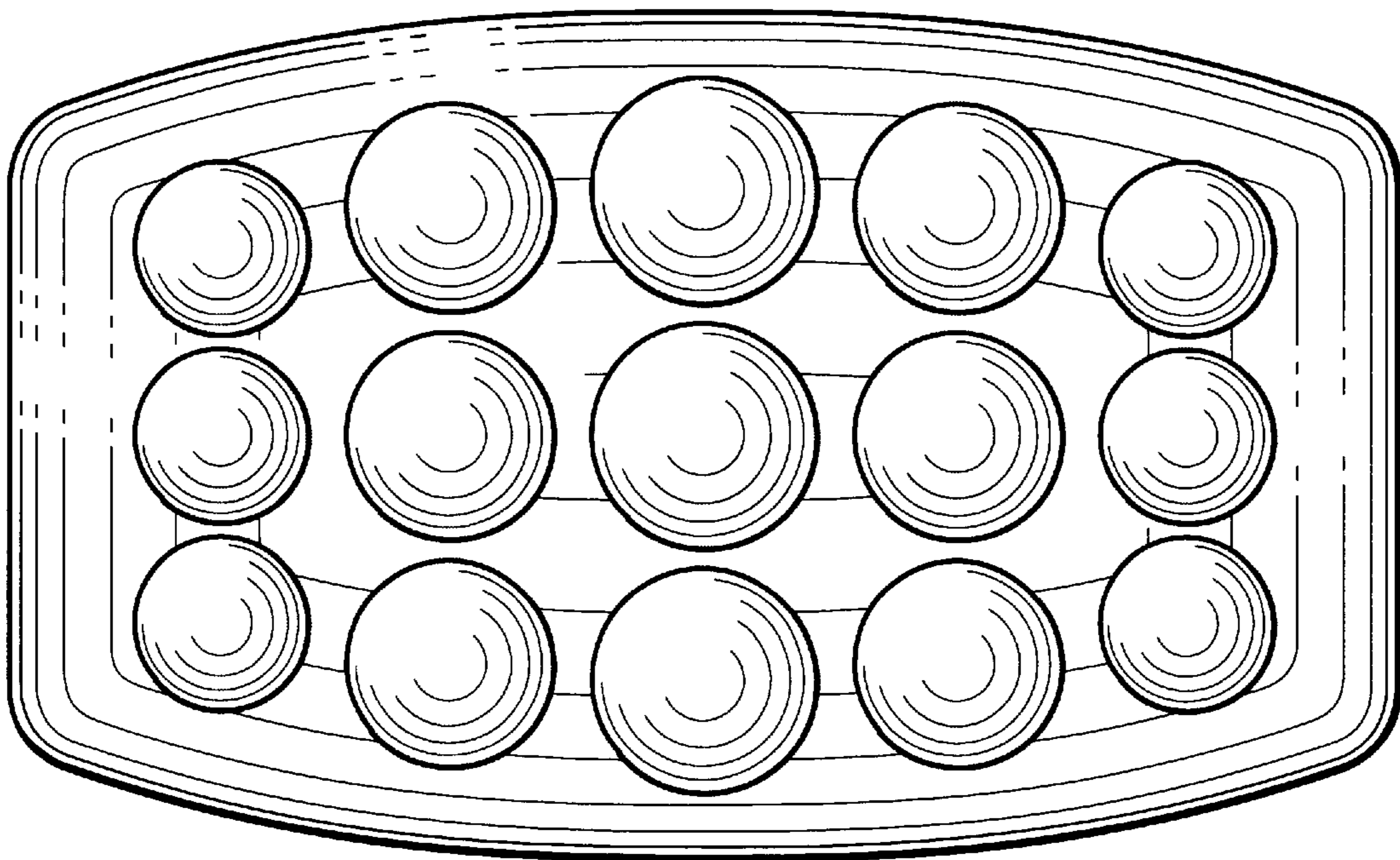

Fig. 3

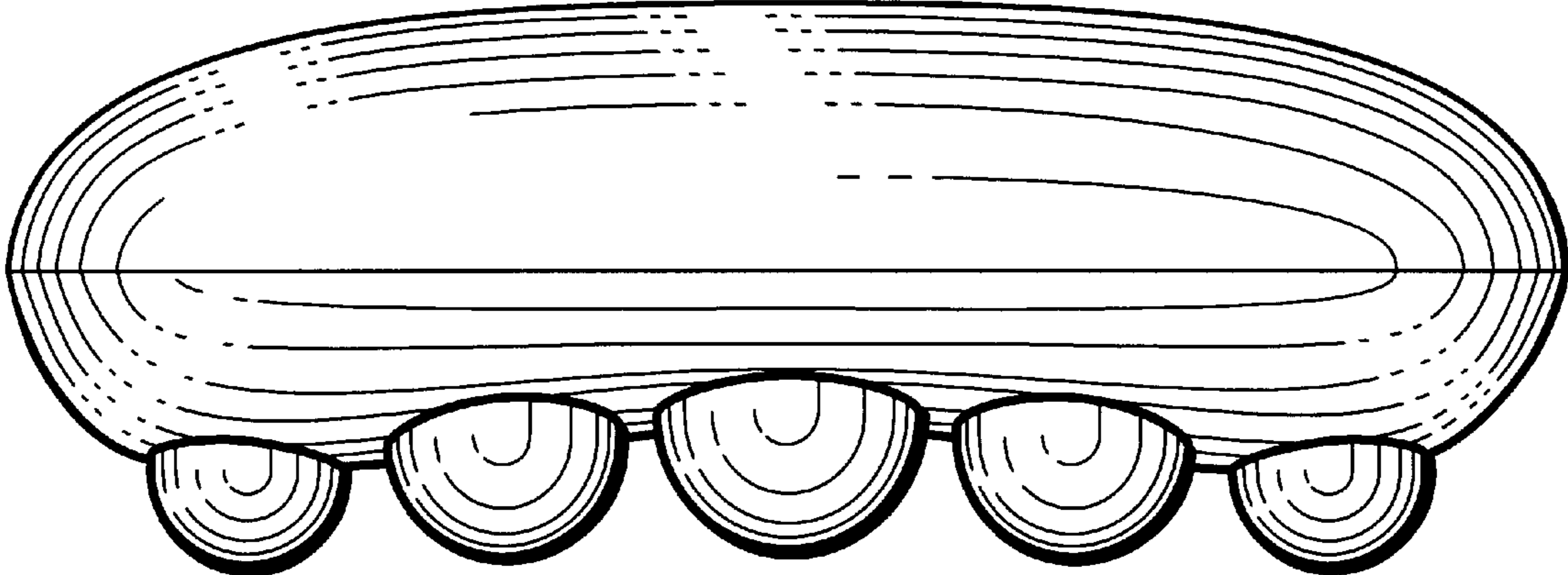

Fig. 4

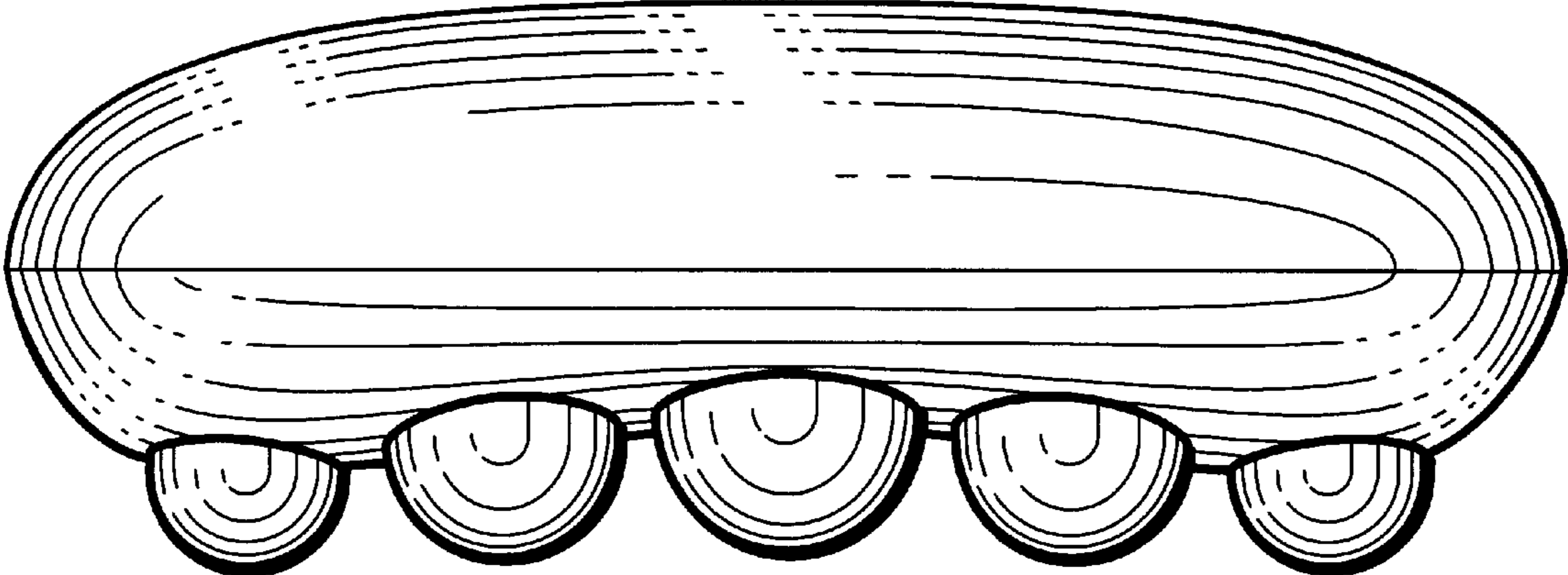

Fig. 5

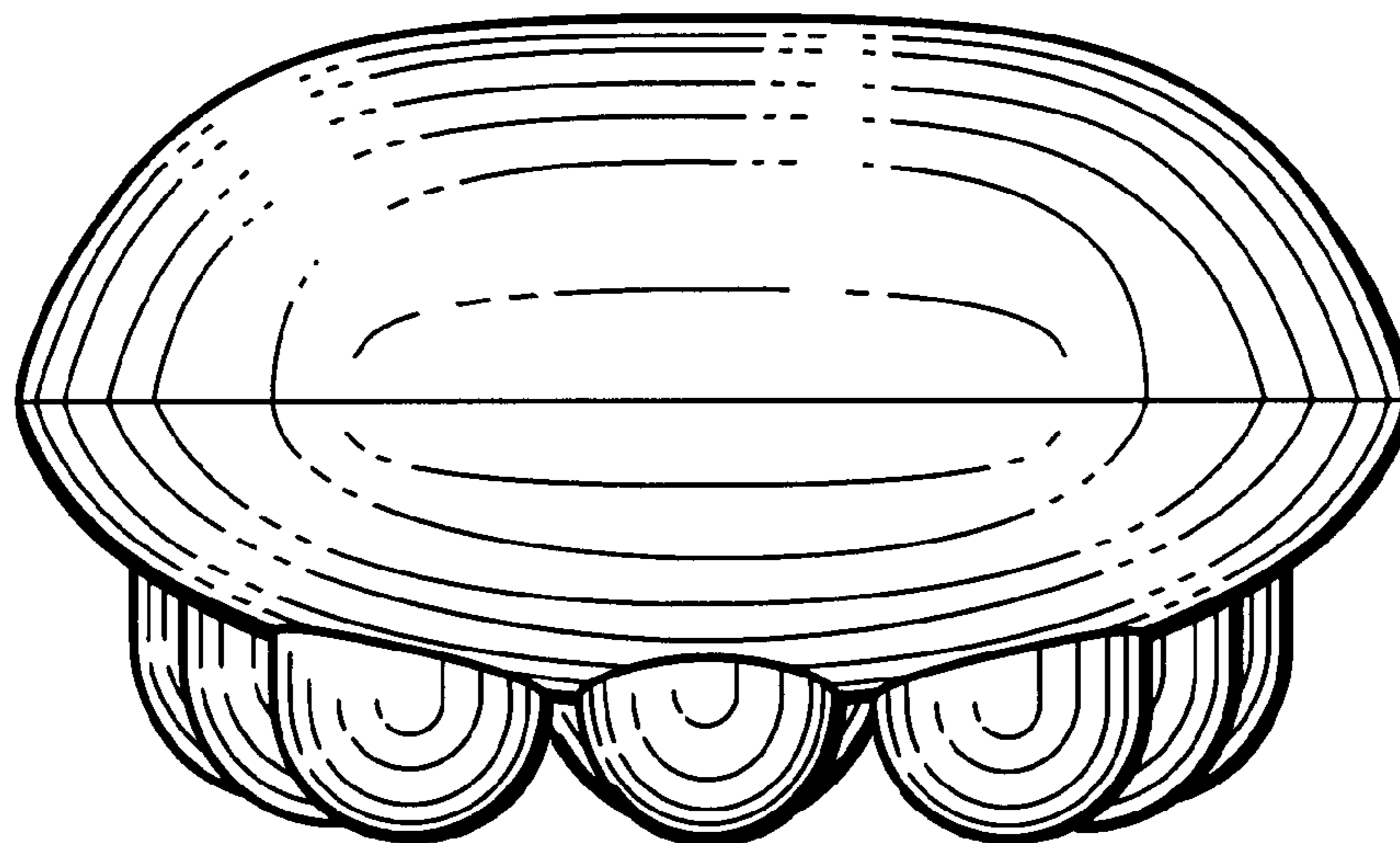

Fig. 6

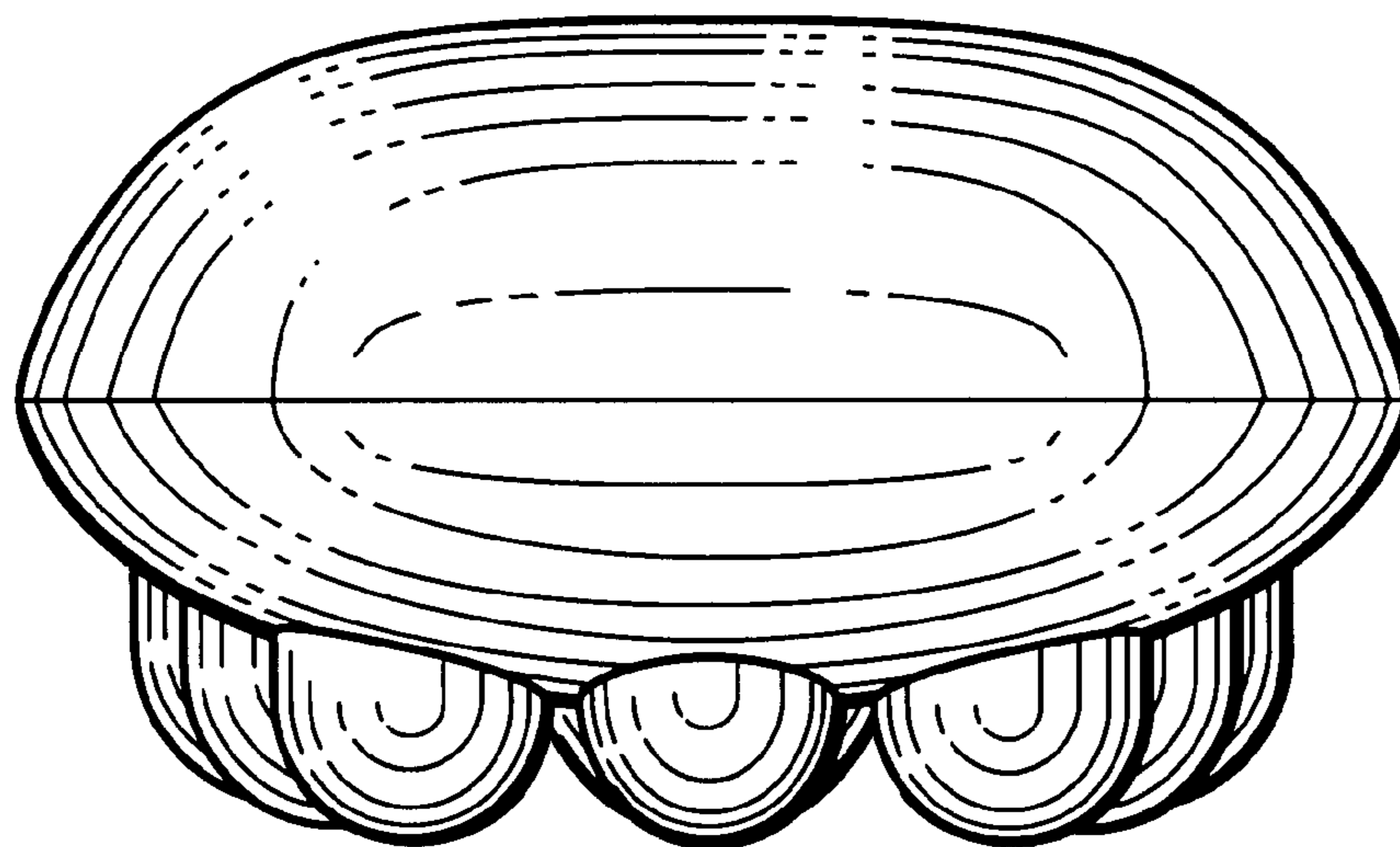

Fig. 7

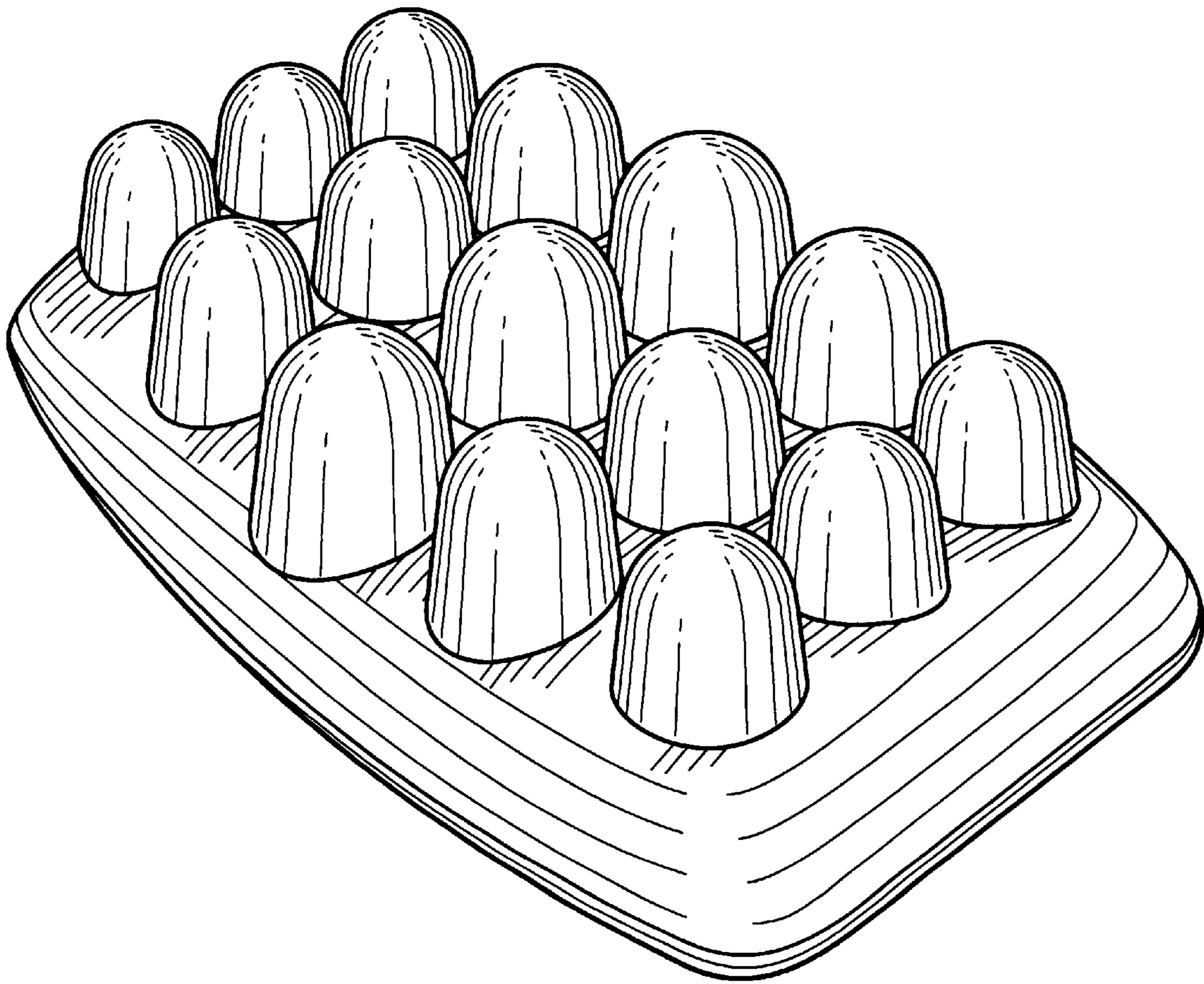

Fig. 8

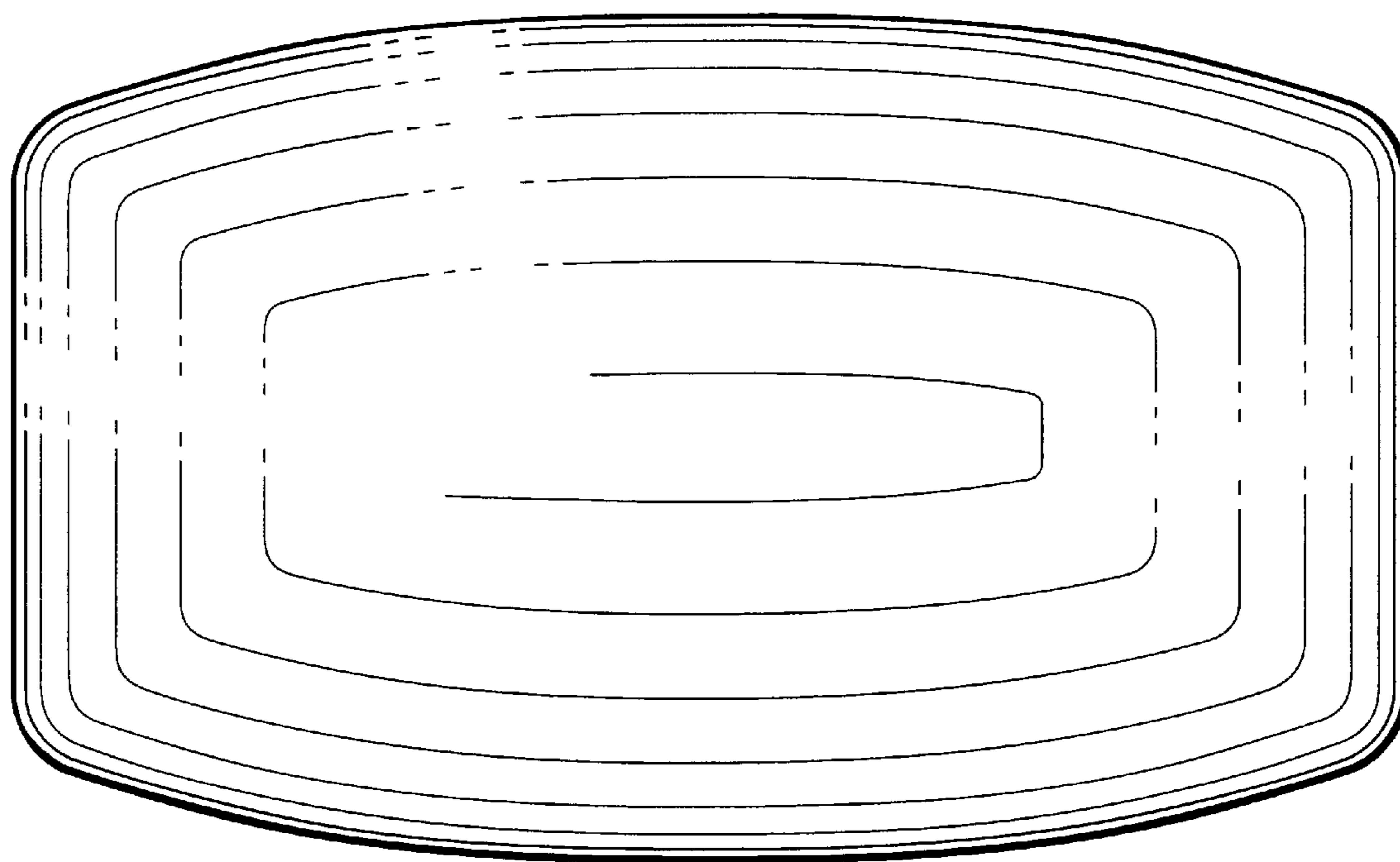

Fig. 9

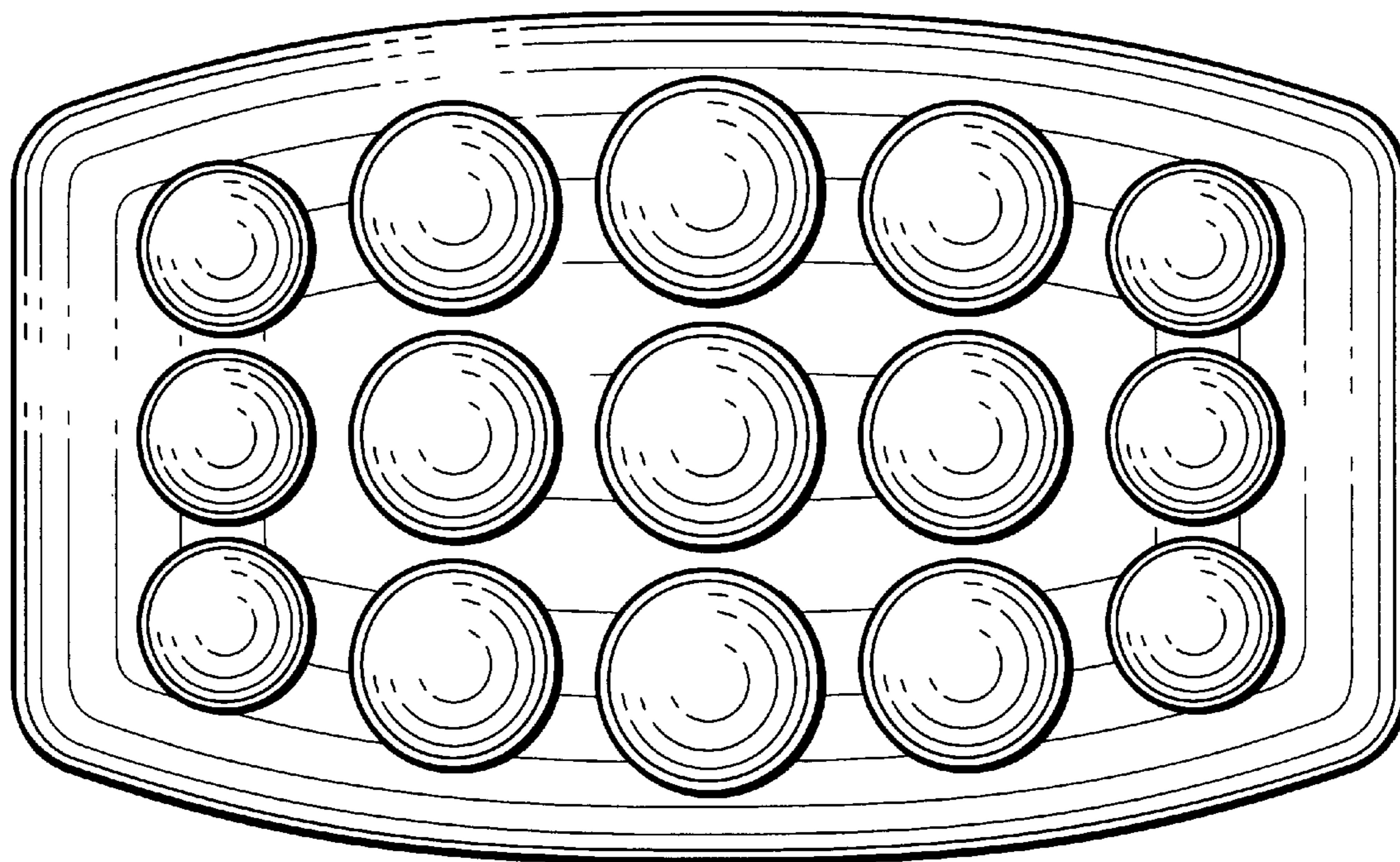

Fig. 10

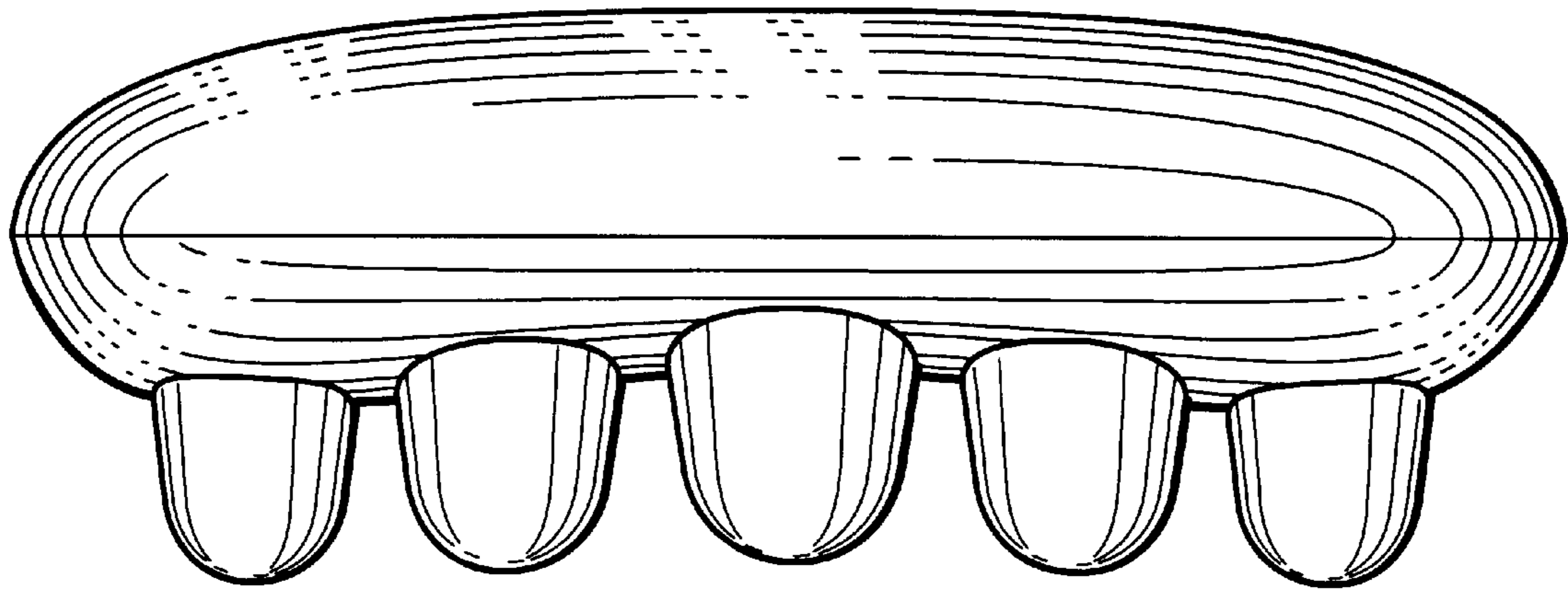

Fig. 11

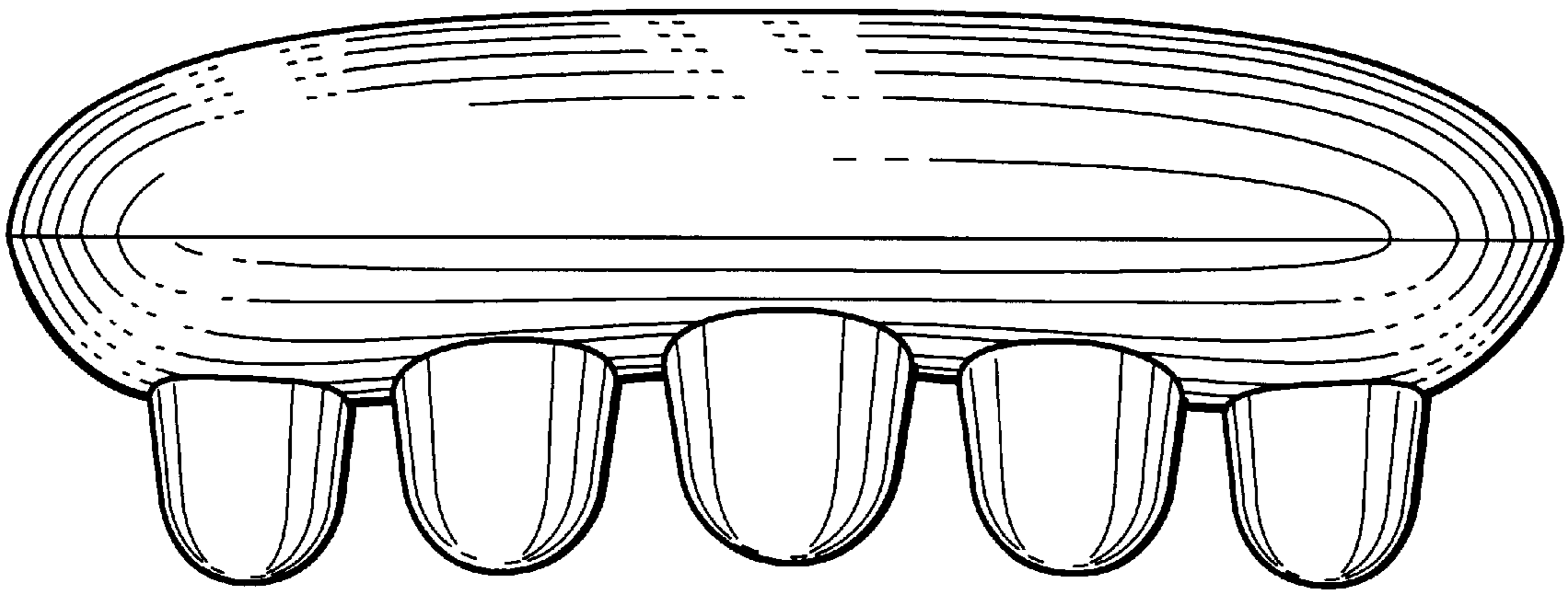

Fig. 12

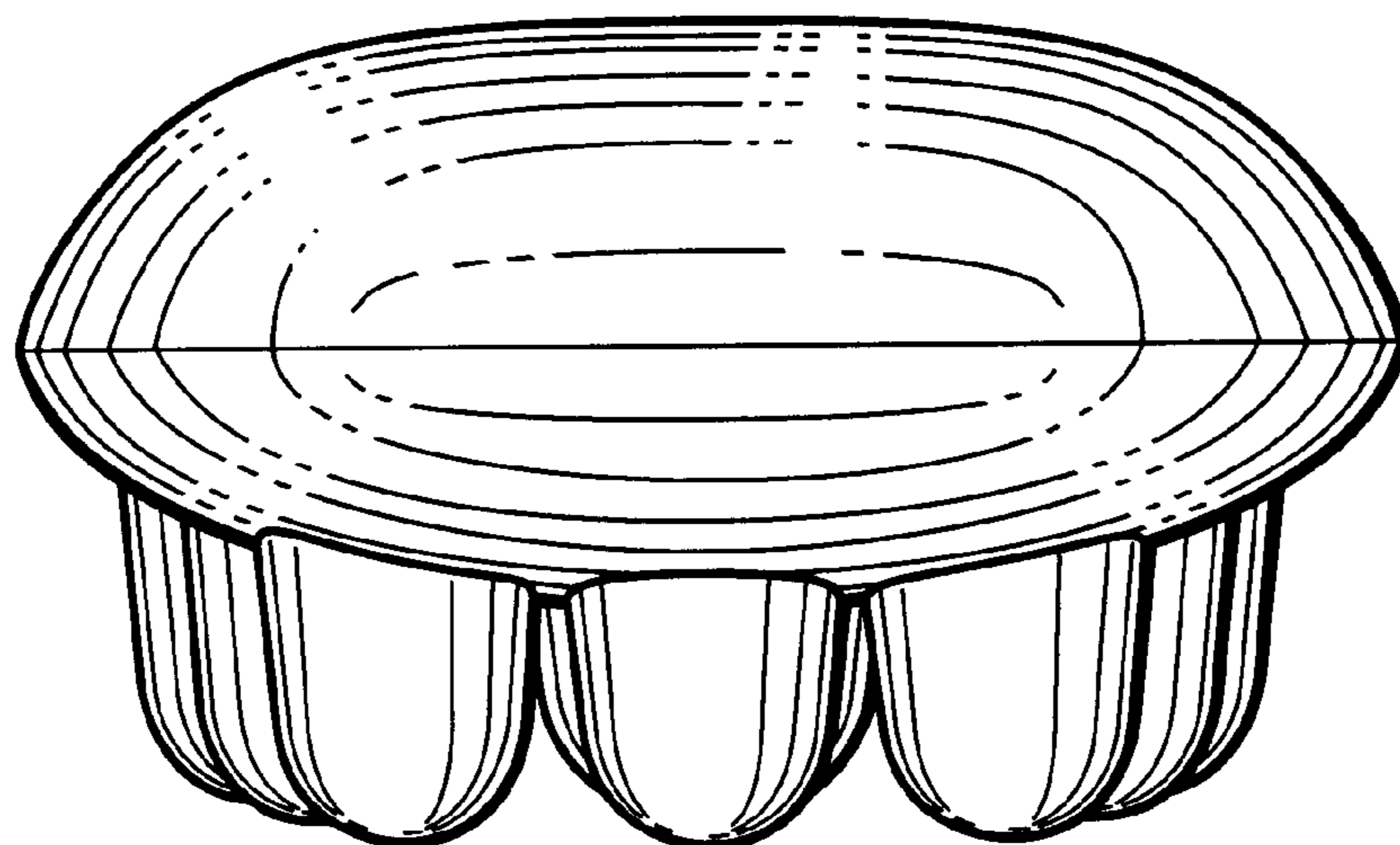

Fig. 13

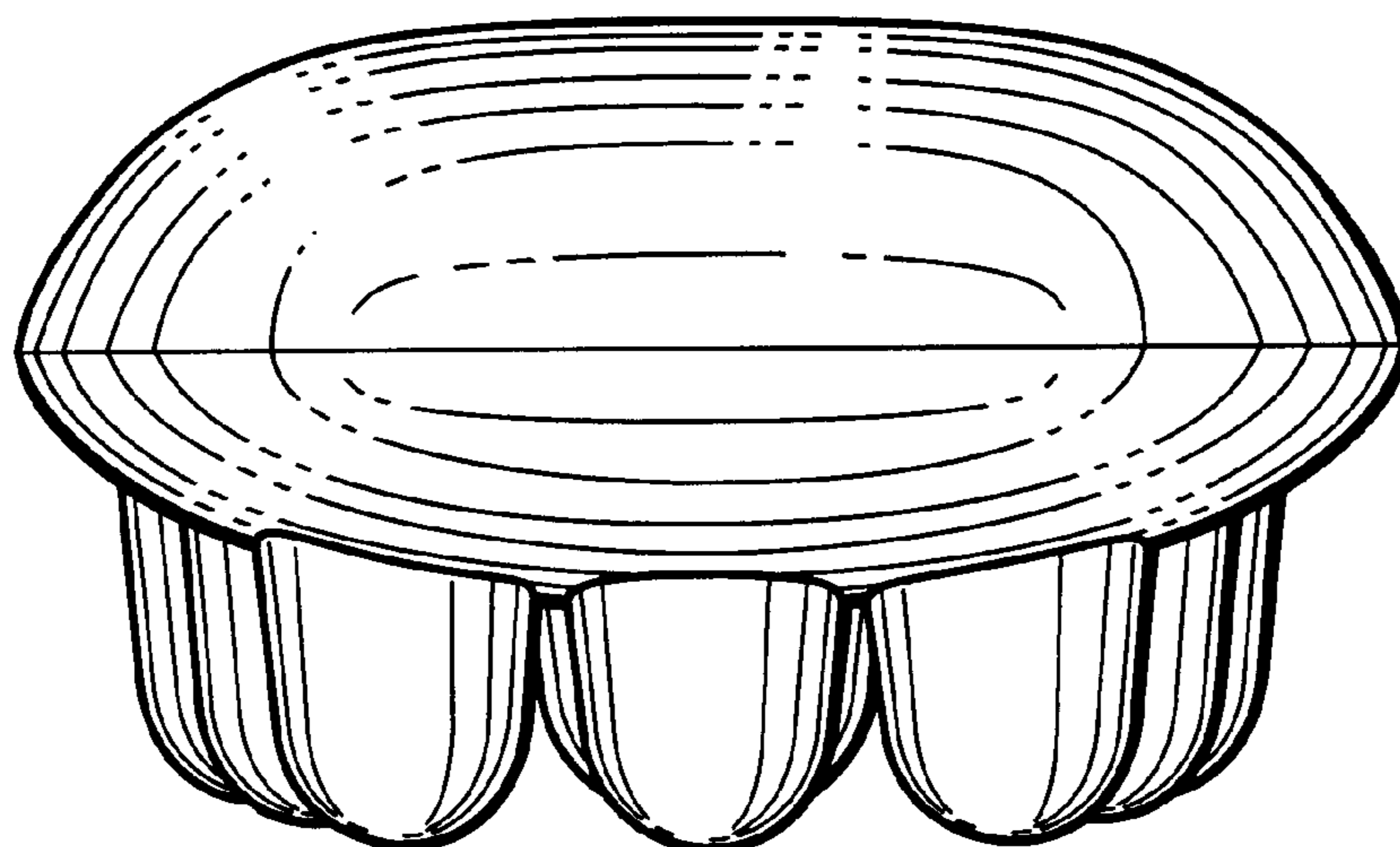

Fig. 14