



US00D527024S

(12) **United States Design Patent**
Happ et al.

(10) **Patent No.:** **US D527,024 S**

(45) **Date of Patent:** **** Aug. 22, 2006**

(54) **POWER PROVIDING AND AIR COMPRESSOR DEVICE**

D444,797 S * 7/2001 Davis et al. D15/9
D454,357 S * 3/2002 Diels D15/7
D488,438 S 4/2004 Zick et al.

(75) Inventors: **Kenneth C. Happ**, Burlington, WI (US); **Martin S. Scolaro**, Burlington, WI (US); **Anil P. Ghode**, Libertyville, IL (US); **Raymond D. Derome**, Twin Lakes, WI (US); **Jesse D. Cotterman**, Grafton, WI (US)

* cited by examiner

Primary Examiner—Ralf Seifert
(74) *Attorney, Agent, or Firm*—Barnes & Thornburg LLP

(73) Assignee: **Snap-on Incorporated**, Kenosha, WI (US)

(57) **CLAIM**

What is claimed is the ornamental design for a power providing and air compressor device, shown and described.

(**) Term: **14 Years**

DESCRIPTION

(21) Appl. No.: **29/196,785**

FIG. 1 is a perspective view of the power providing and air compressor device, a battery unit, flashlight, pressure gauge, vents and power switch being shown in broken line;

(22) Filed: **Jan. 5, 2004**

FIG. 2 is a front elevational view thereof;

(51) **LOC (8) Cl.** **15-02**

FIG. 3 is a rear elevational view thereof;

(52) **U.S. Cl.** **D15/7**

FIG. 4 is a right side elevational view thereof;

(58) **Field of Classification Search** D15/7-9;
417/321, 410, 413.1, 415, 423.3, 486, 521,
417/534; 415/148

FIG. 5 is a left side elevational view thereof;

See application file for complete search history.

FIG. 6 is a top plan view thereof; and,

FIG. 7 is a bottom plan view thereof.

The broken lines are shown in the views for illustrative purposes only and form no part of the claimed invention.

(56) **References Cited**

U.S. PATENT DOCUMENTS

4,419,048 A * 12/1983 Pilachowski et al. 415/196

1 Claim, 7 Drawing Sheets

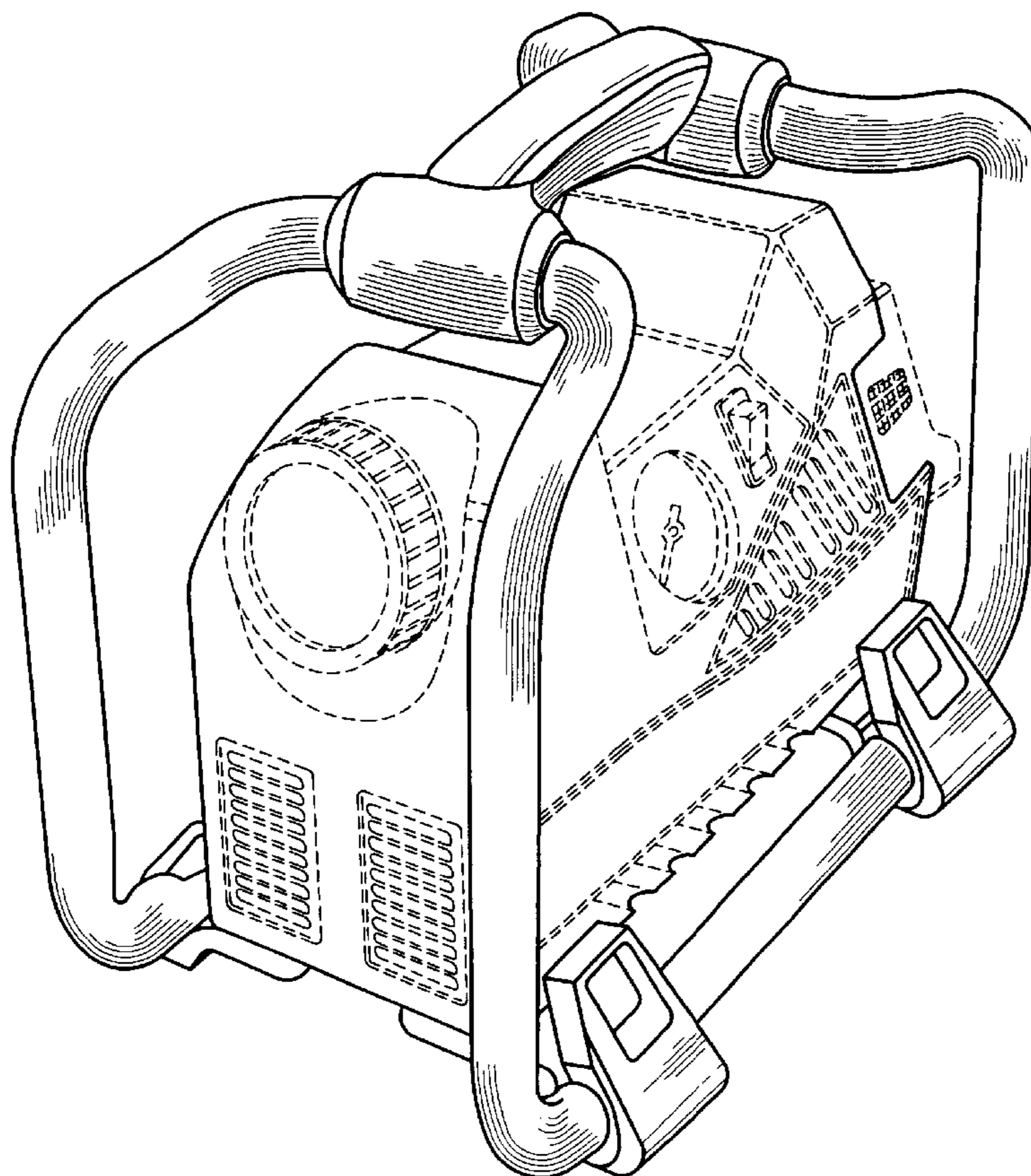

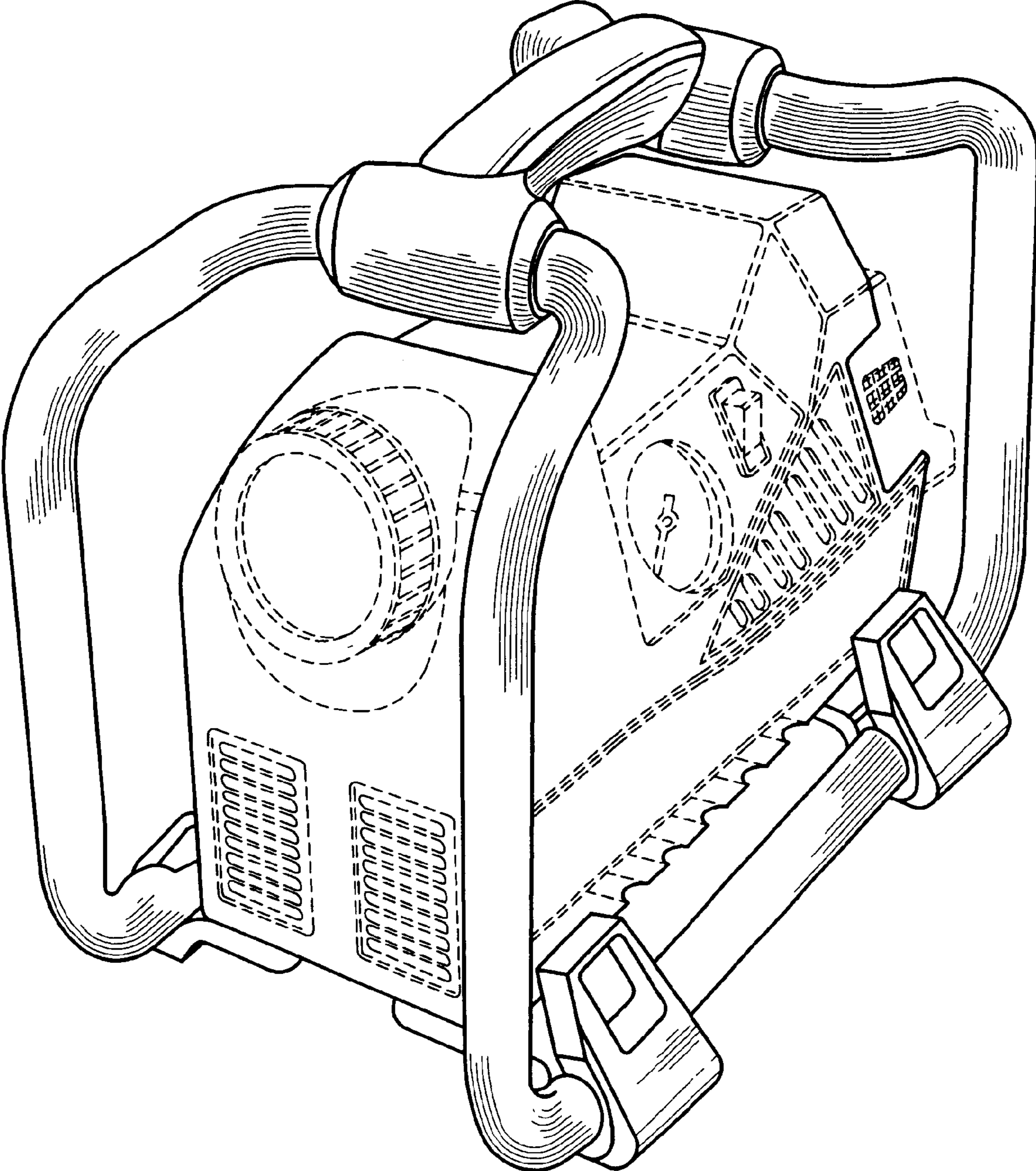

FIG. 1

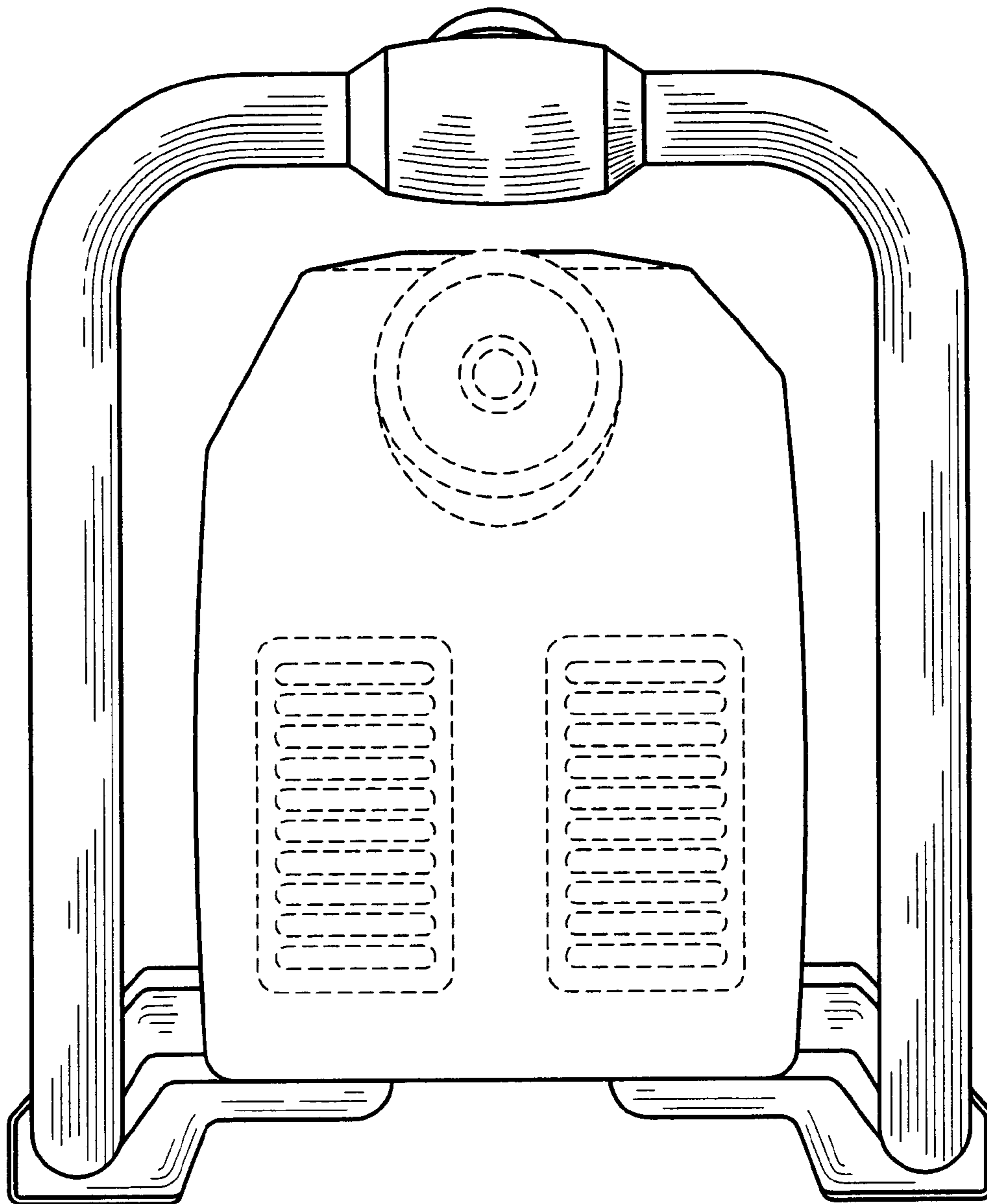

FIG. 2

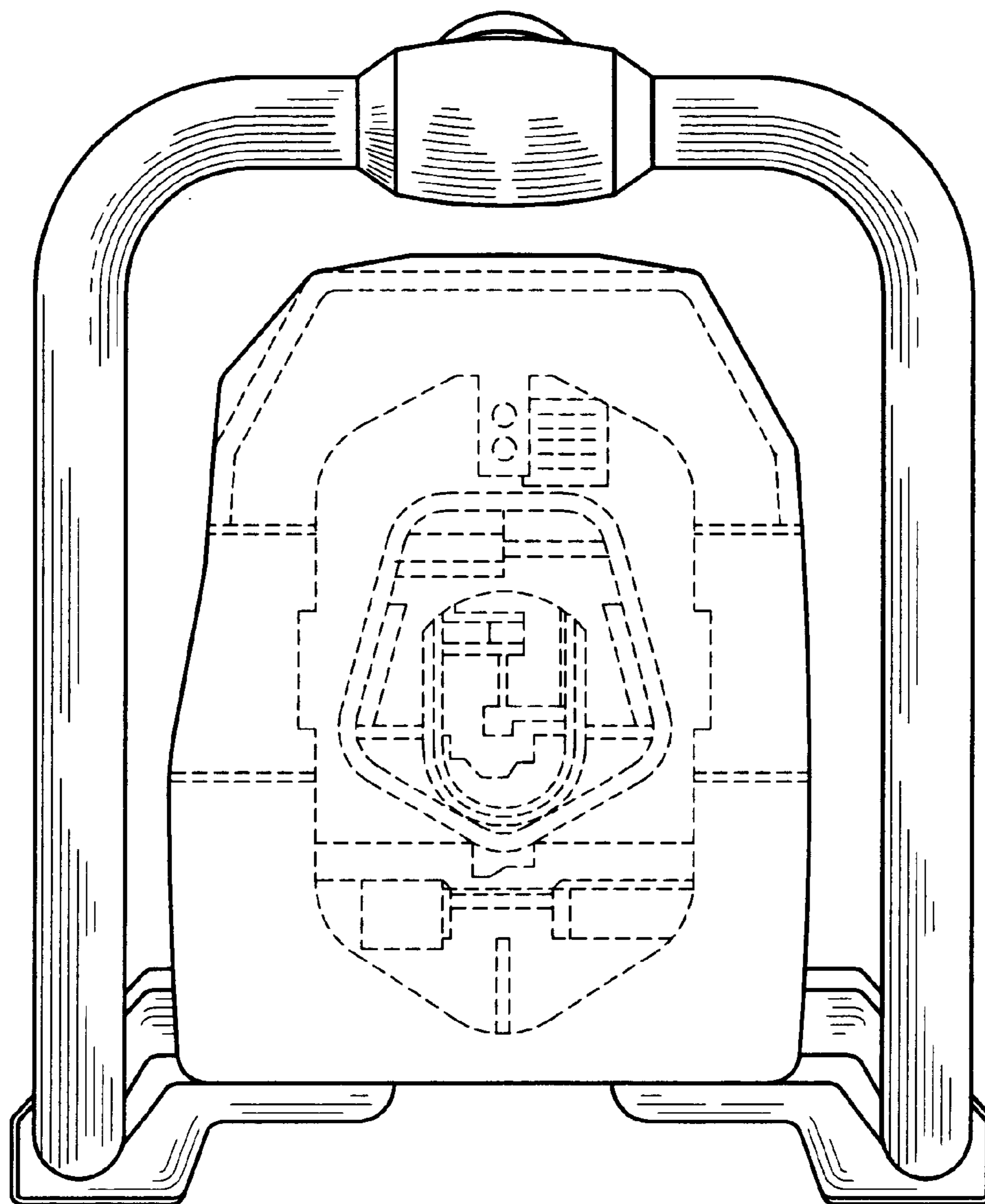

FIG. 3

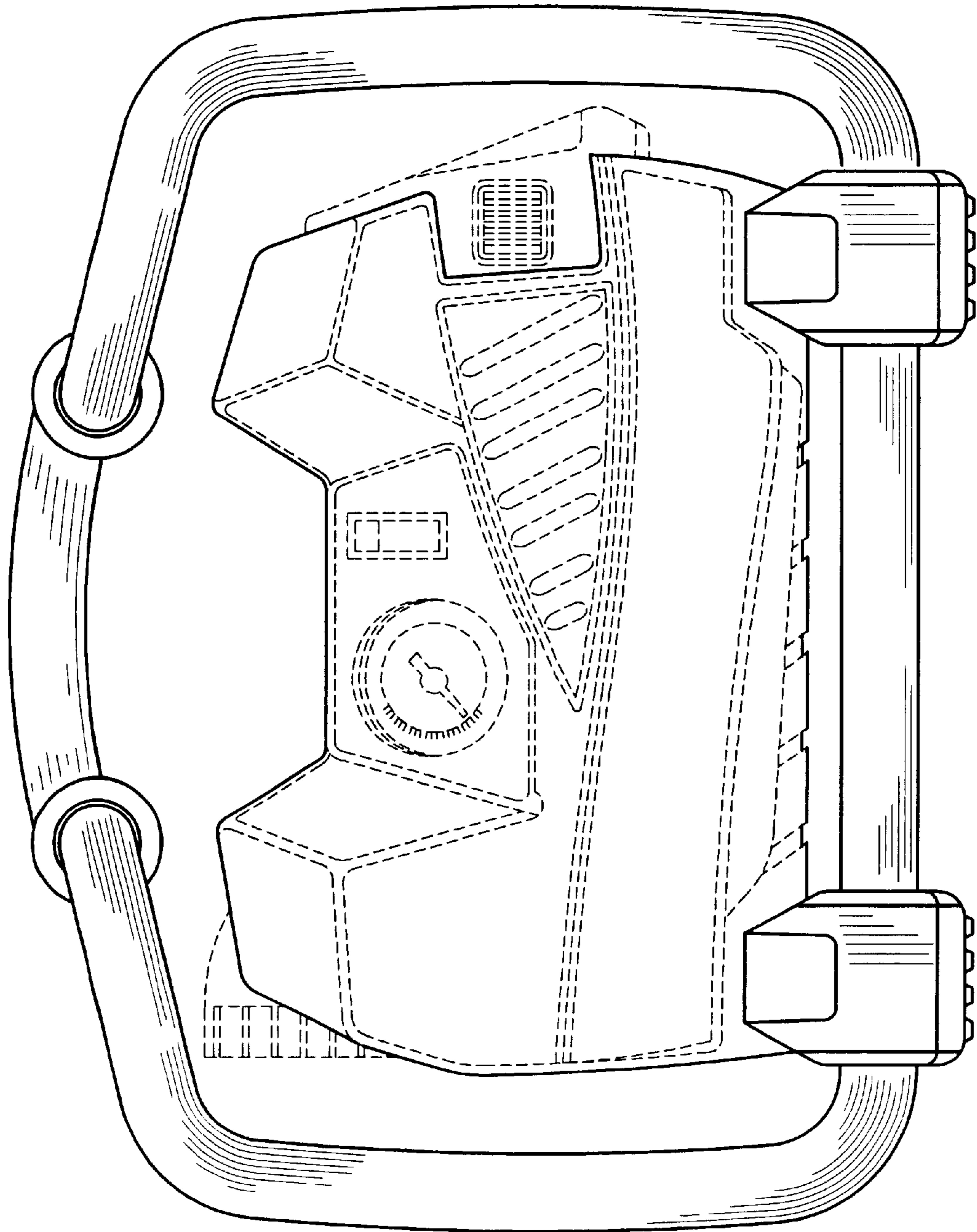

FIG. 4

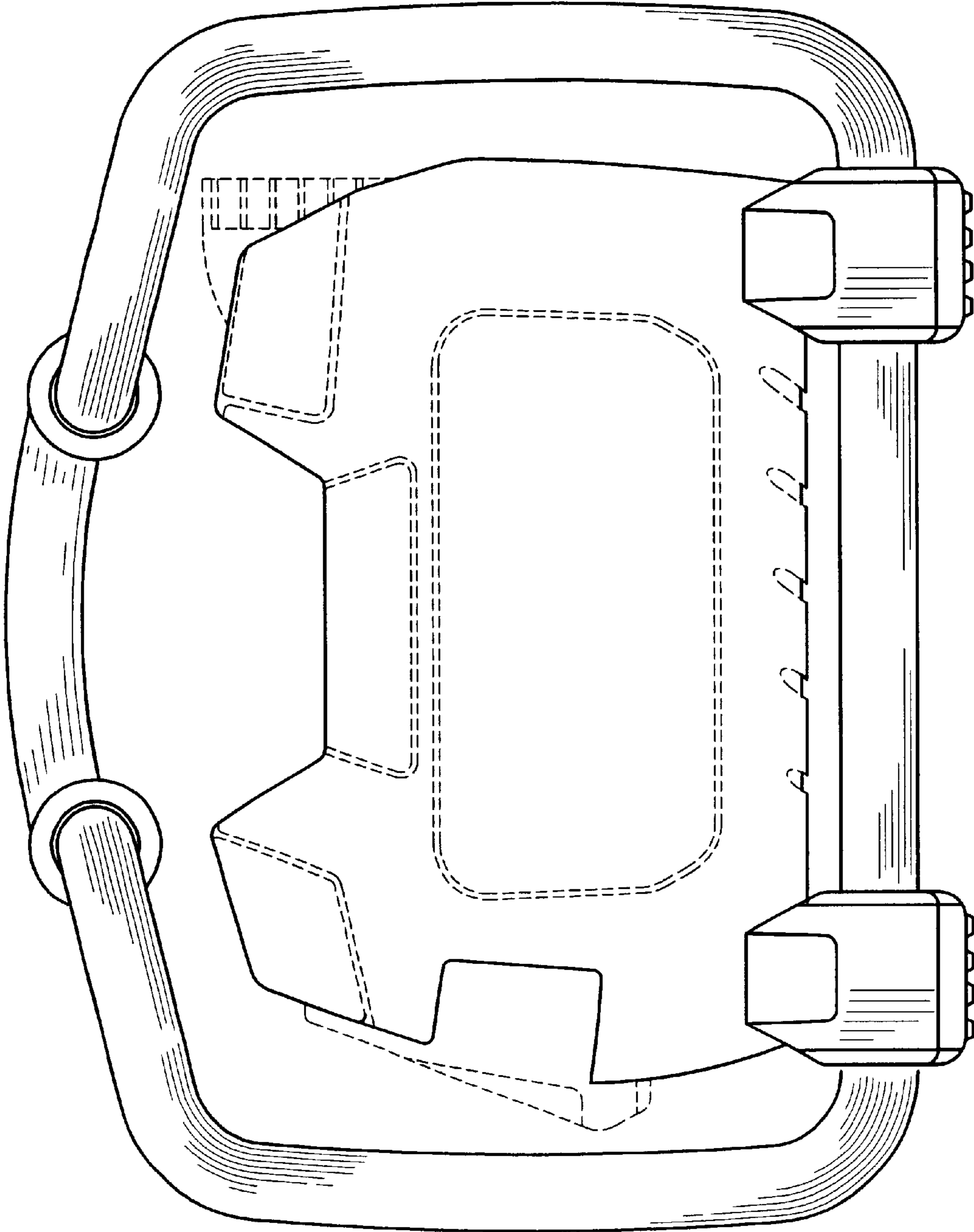

FIG. 5

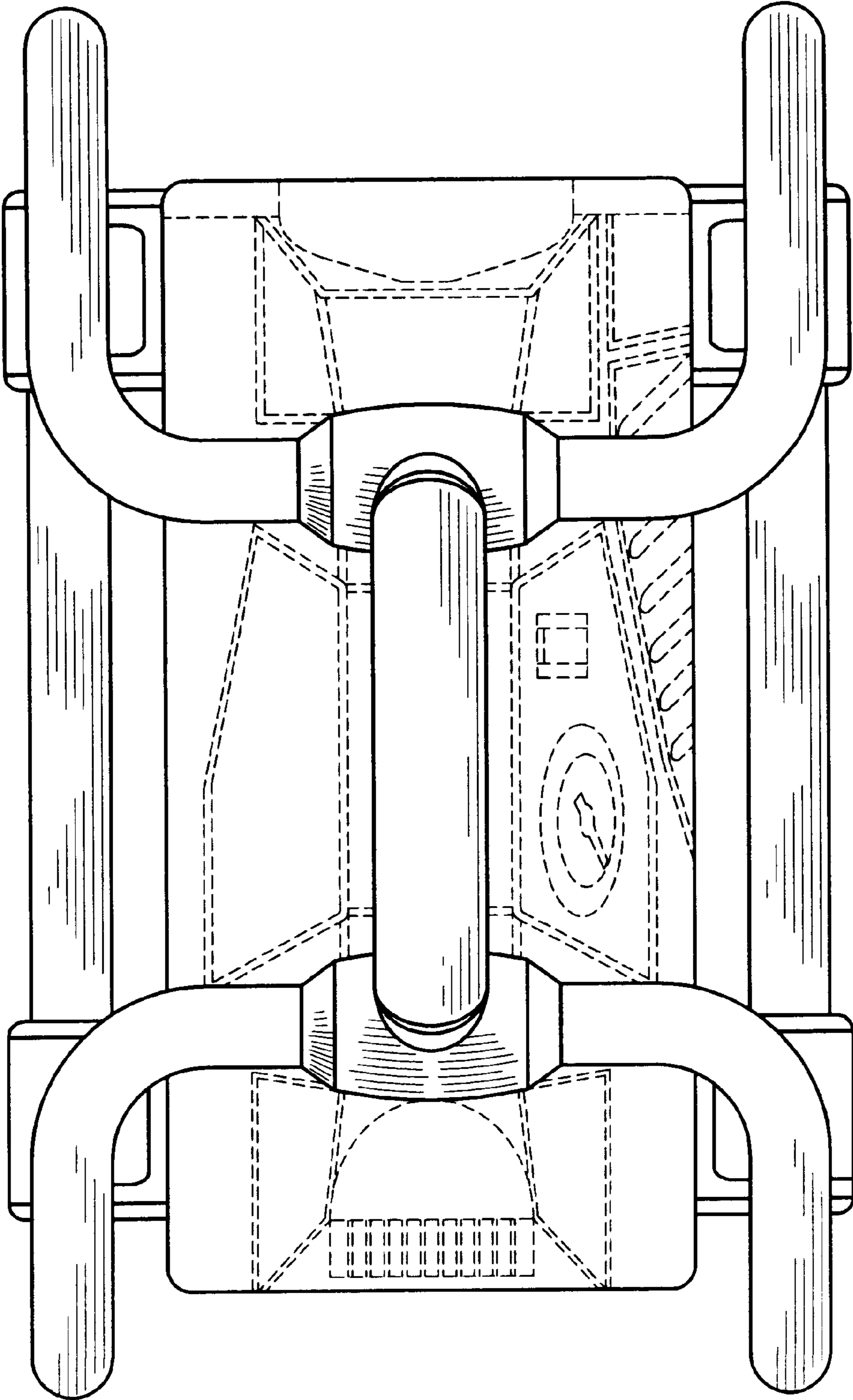

FIG. 6

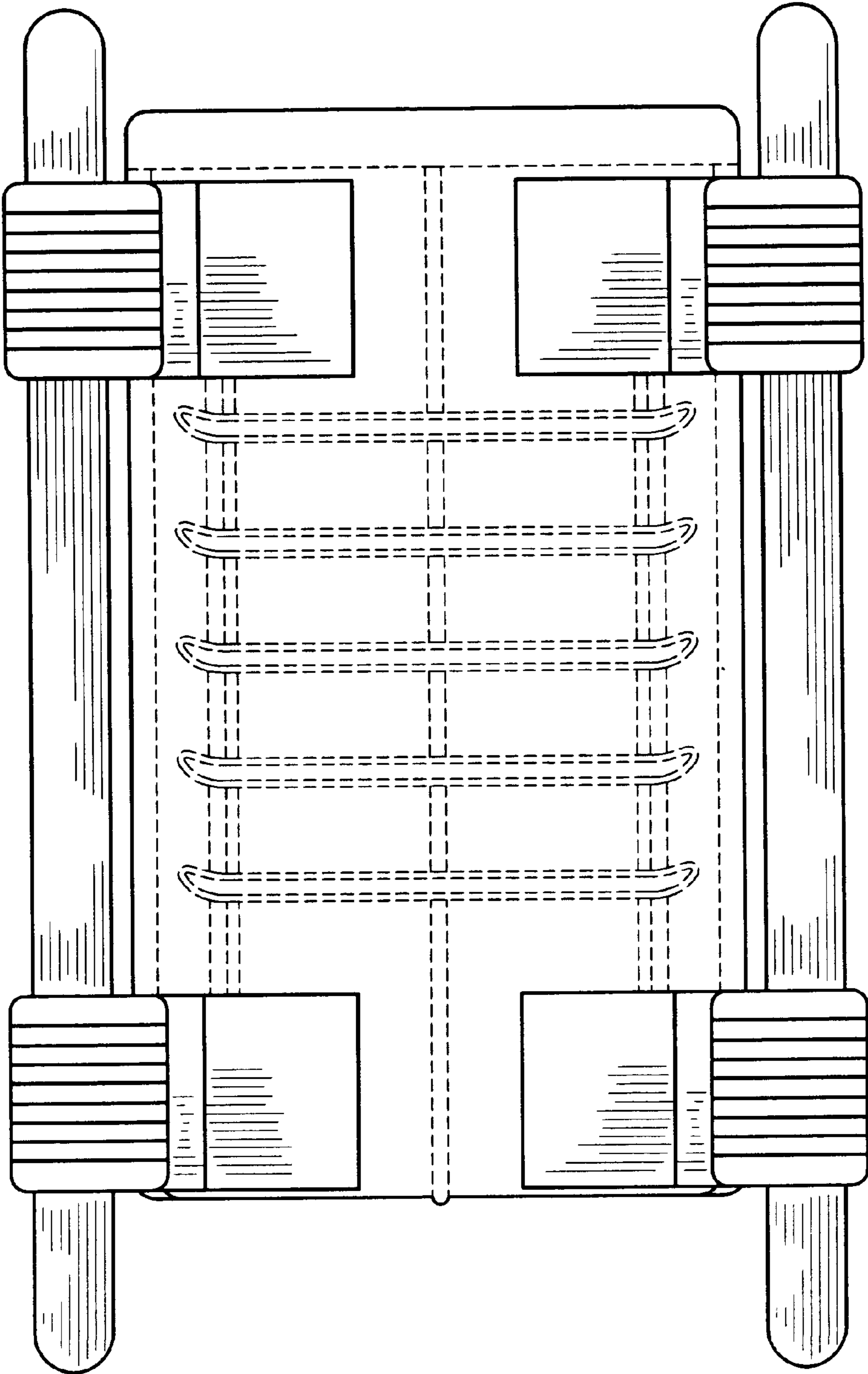

FIG. 7