



US00D526992S

(12) **United States Design Patent**
Sakai

(10) **Patent No.:** **US D526,992 S**

(45) **Date of Patent:** **** Aug. 22, 2006**

(54) **COMBINED DISC PLAYER AND RADIO RECEIVER**

(75) Inventor: **Wakaba Sakai**, Tokyo (JP)

(73) Assignee: **Sony Corporation**, Tokyo (JP)

(**) Term: **14 Years**

(21) Appl. No.: **29/213,264**

(22) Filed: **Sep. 16, 2004**

(51) **LOC (8) Cl.** **14-01**

(52) **U.S. Cl.** **D14/168**

(58) **Field of Classification Search** D14/156,
D14/160-165, 167-168, 192-198, 188, 445;
360/99.02, 99.07; 369/75.11, 75.21, 77.21,
369/77.11; 720/612, 619, 647, 655; 455/344,
455/347-351

See application file for complete search history.

(56) **References Cited**

U.S. PATENT DOCUMENTS

D399,507 S	10/1998	Kanno	
D420,000 S	* 2/2000	Yoneda D14/168
D442,160 S	* 5/2001	Tsuchiya D14/168
D449,589 S	10/2001	Ishibashi et al.	
D454,856 S	3/2002	Kobayashi	
D457,880 S	* 5/2002	Suzuki et al. D14/168
D475,360 S	6/2003	Yoneda et al.	

OTHER PUBLICATIONS

Web page "CSD-A300" <http://www.jp.aiwa.com/products/portableaudio/radics/CSD-A300.html>, 1 sheet, Sony Marketing (Japan) Inc. (Sep. 2004).

Web page "ZS-X3CP" <http://www.sony.co.cr/corporate?page=productosDetalles&model=CFD-F10&top=1891>, 1 sheet, Sony Ecuador (Sep. 2004).

Web page "CFD-F10" <http://www.sony.com.ec/corporate?page=productosDetalles&top=1932&model=ZS-X3CP> 1 sheet, Sony El Salvador (Sep. 2004).

* cited by examiner

Primary Examiner—Nanda Bondade

(74) *Attorney, Agent, or Firm*—Rader, Fishman & Grauer PLLC

(57) **CLAIM**

The ornamental design for a combined disc player and radio receiver, as shown.

DESCRIPTION

FIG. 1 is a perspective view of a combined disc player and radio receiver showing my new design; FIG. 2 is a front elevational view thereof; FIG. 3 is a rear elevational view thereof; FIG. 4 is a left side elevational view thereof; FIG. 5 is a right side elevational view thereof; FIG. 6 is a top plan view thereof; and, FIG. 7 is a bottom plan view thereof.

1 Claim, 4 Drawing Sheets

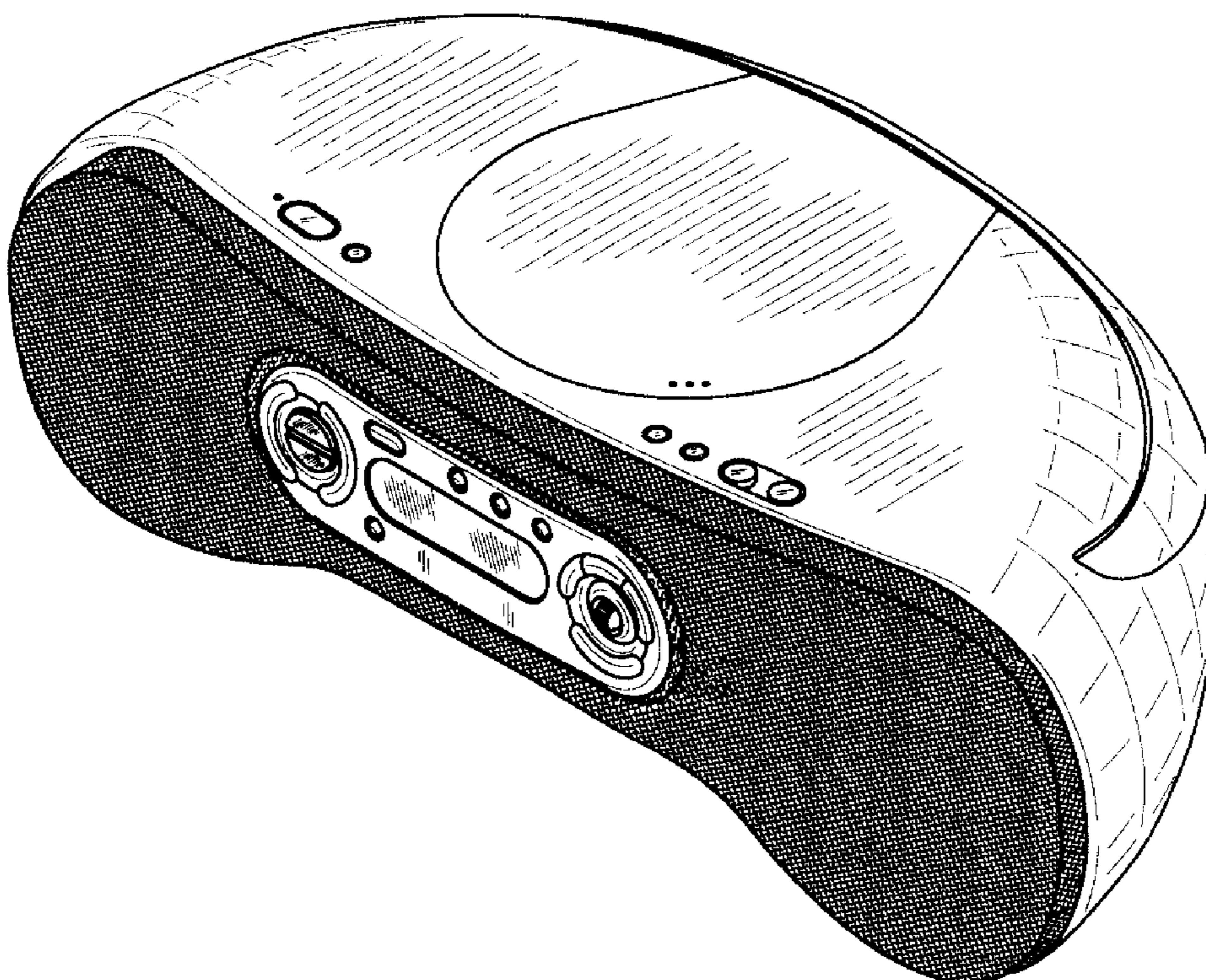

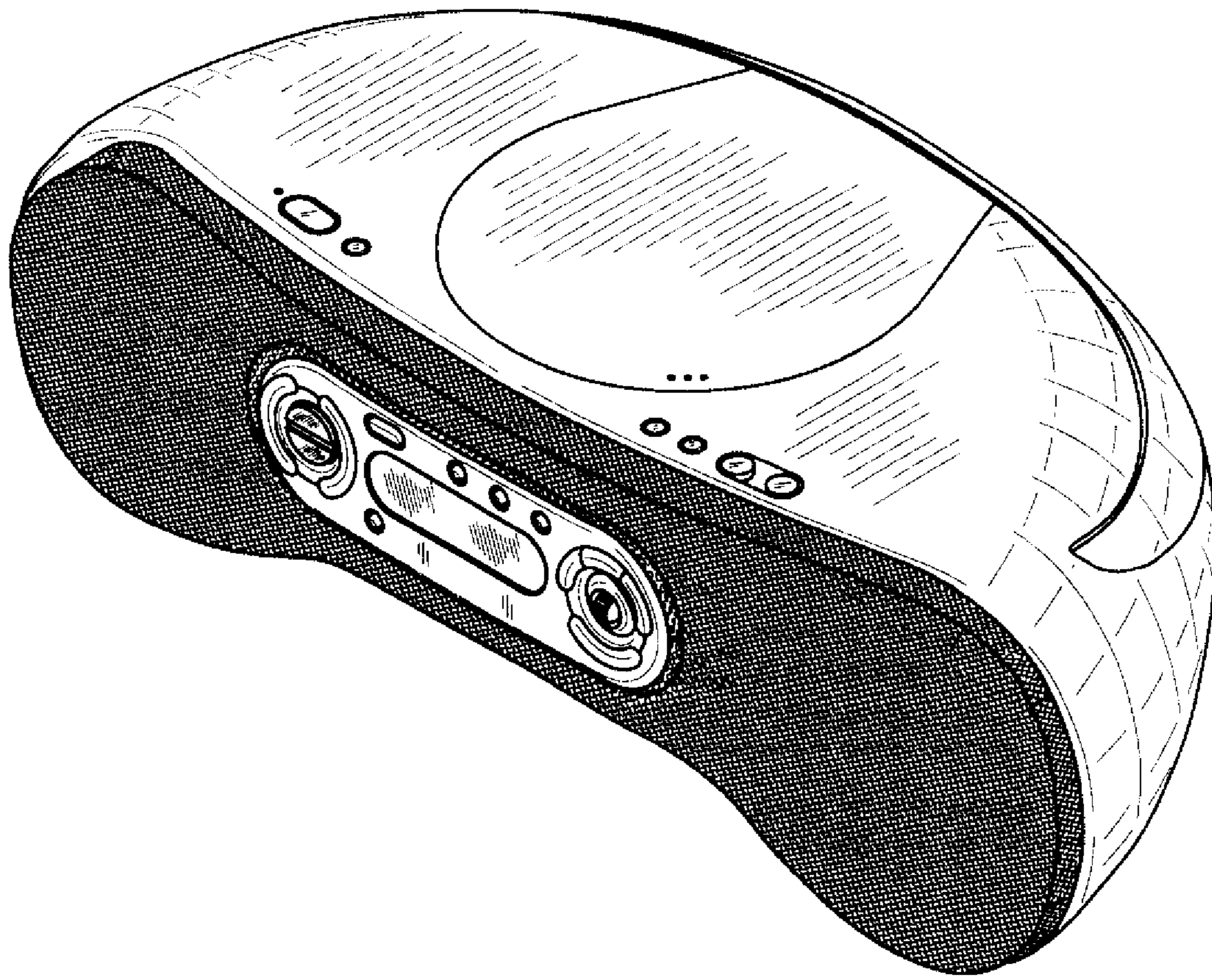

FIG. 1

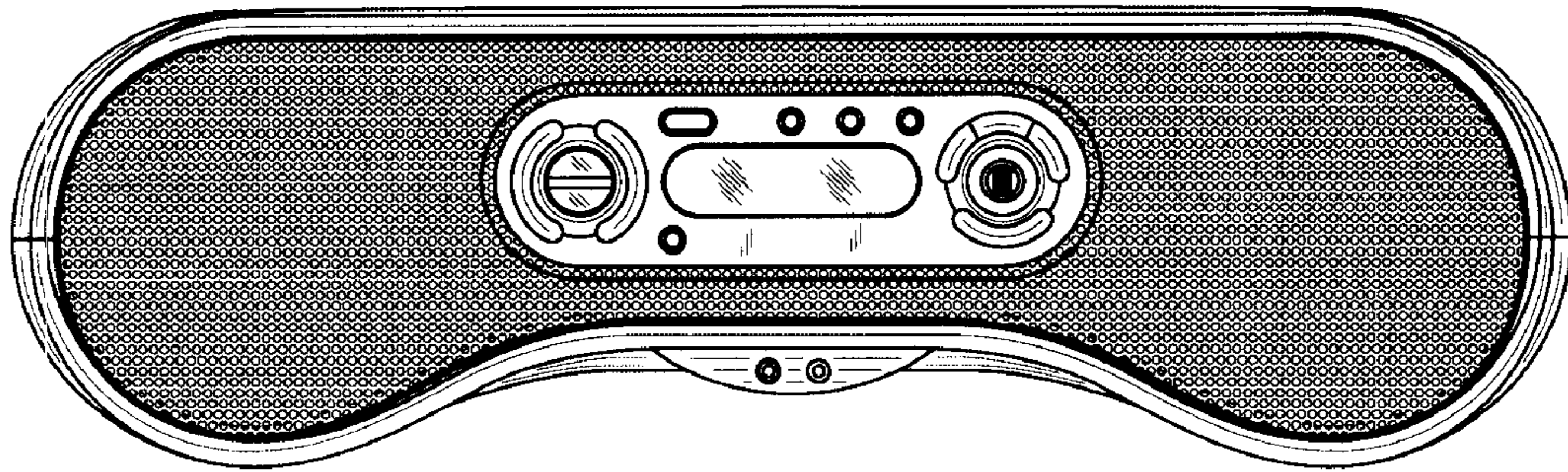

FIG. 2

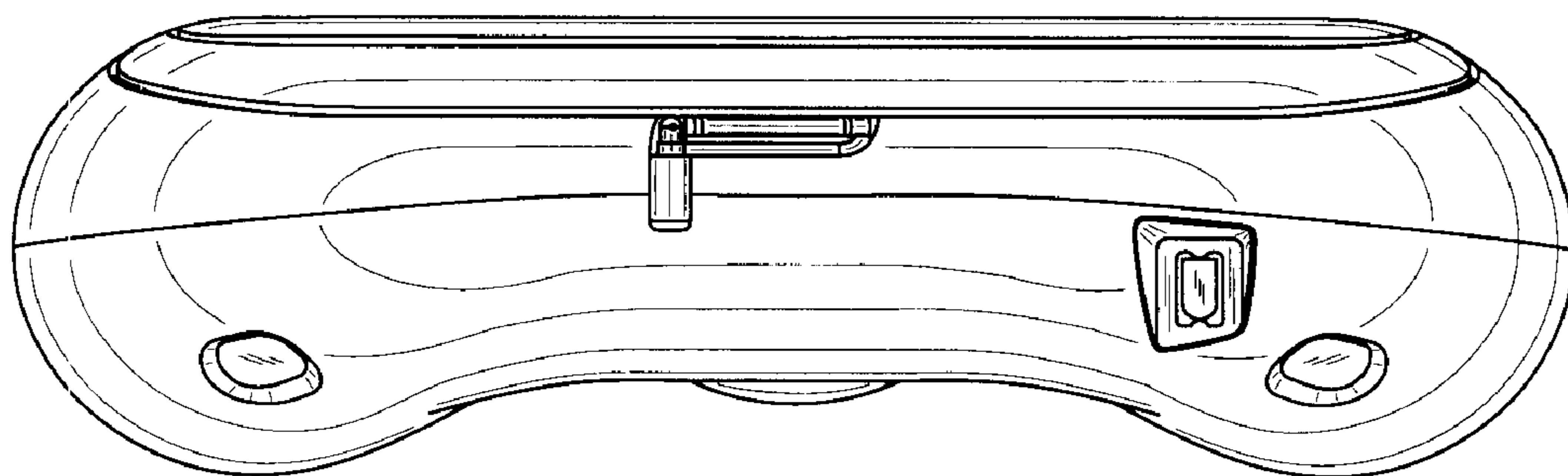

FIG. 3

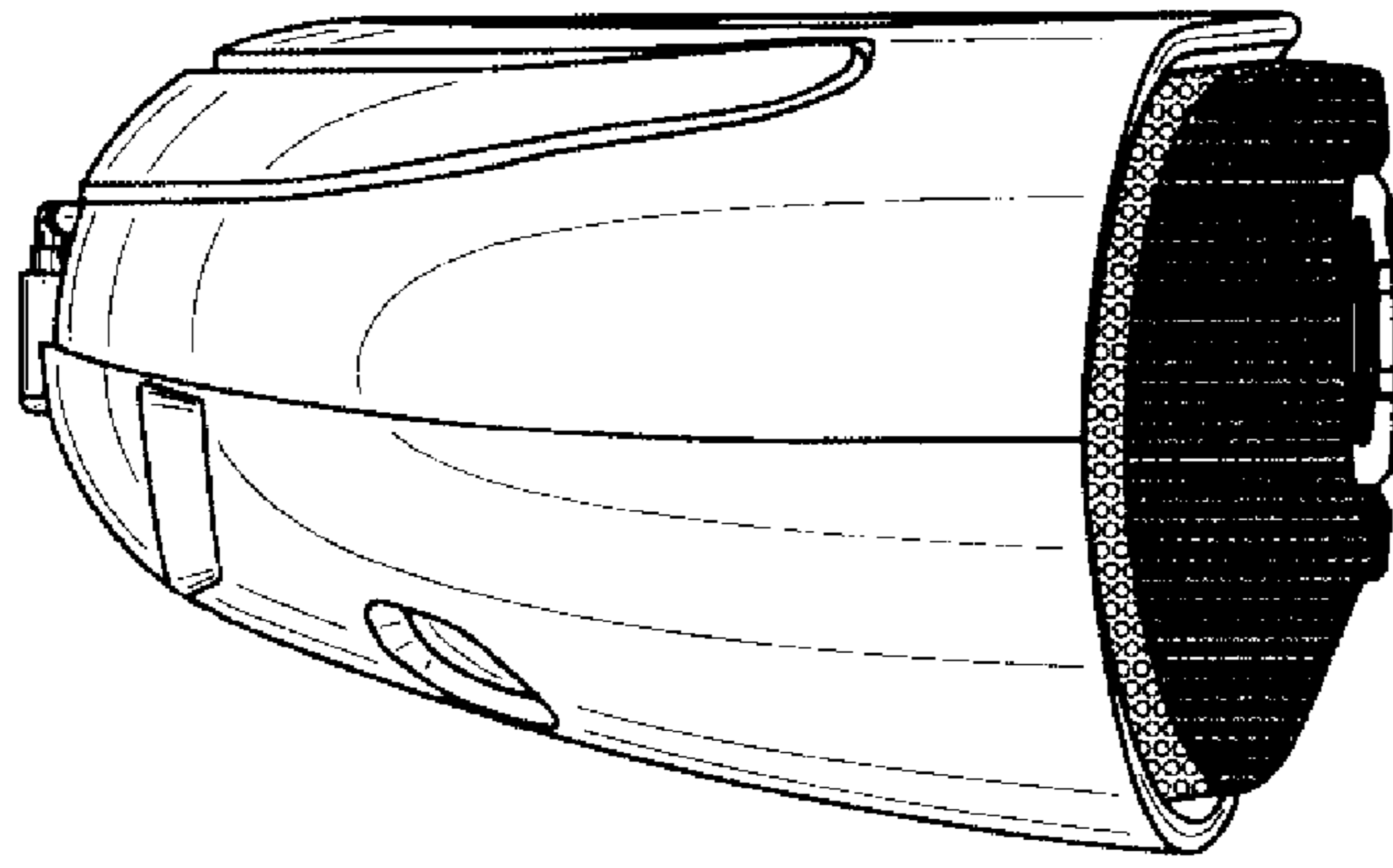

FIG. 4

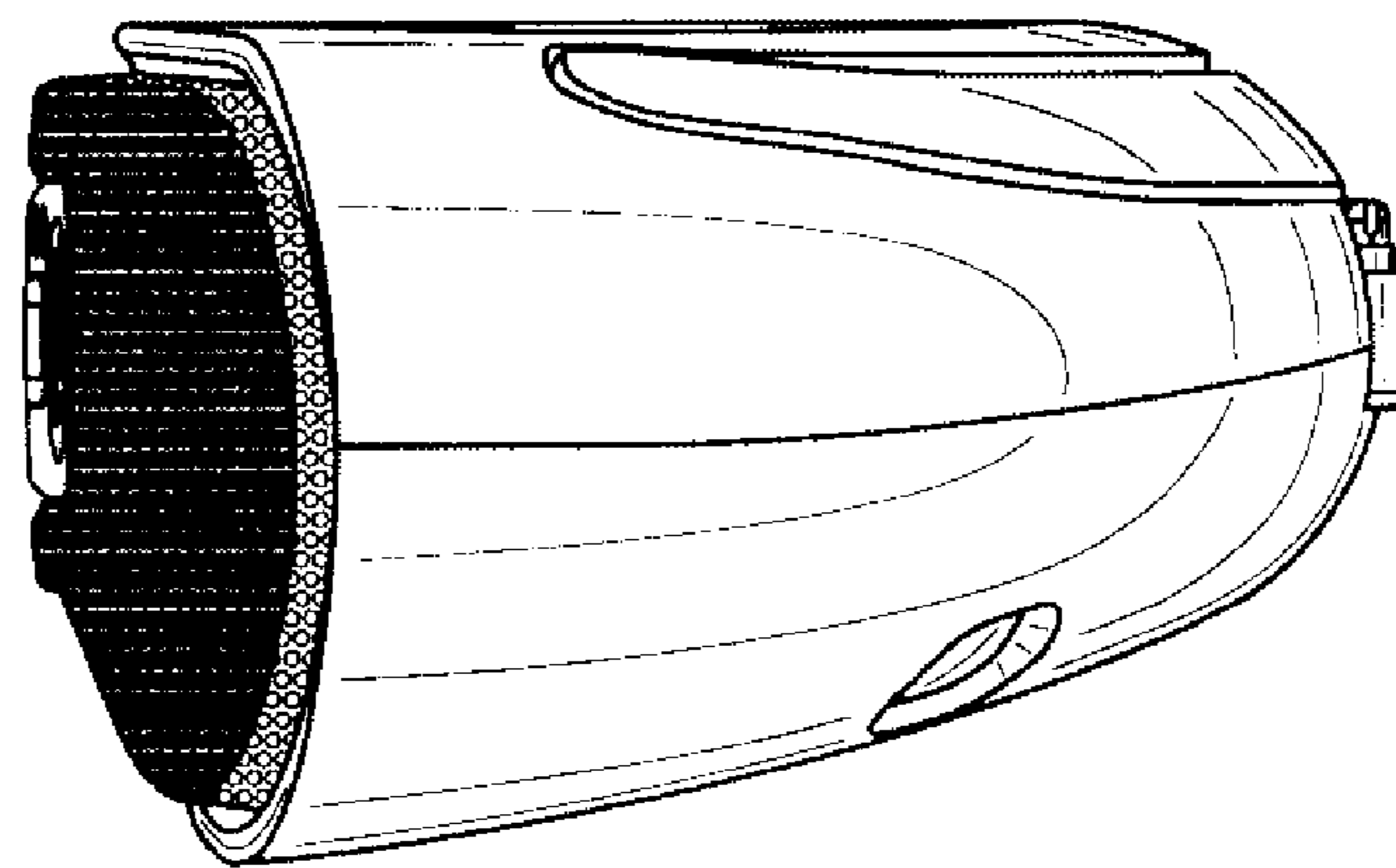

FIG. 5

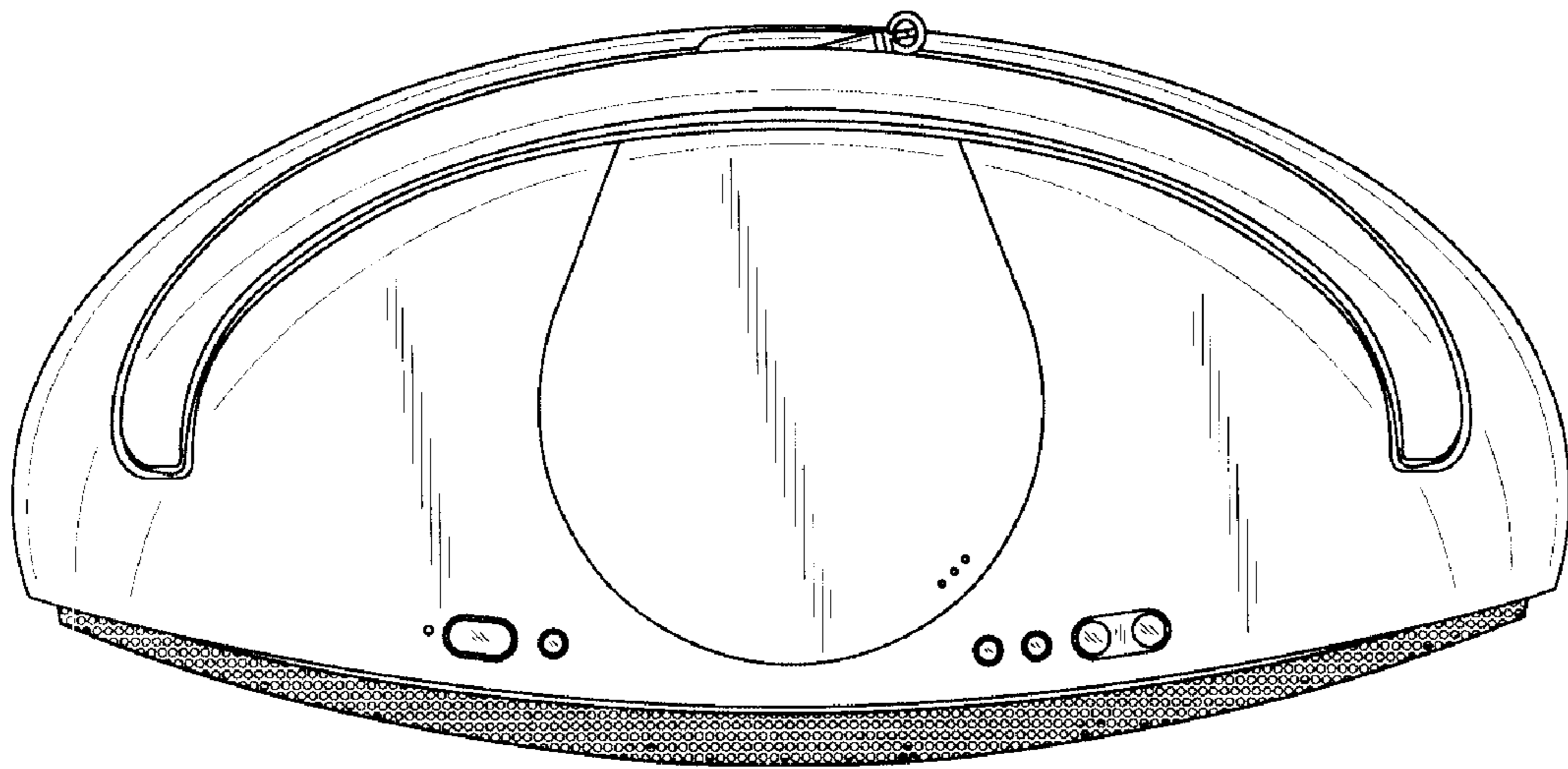

FIG. 6

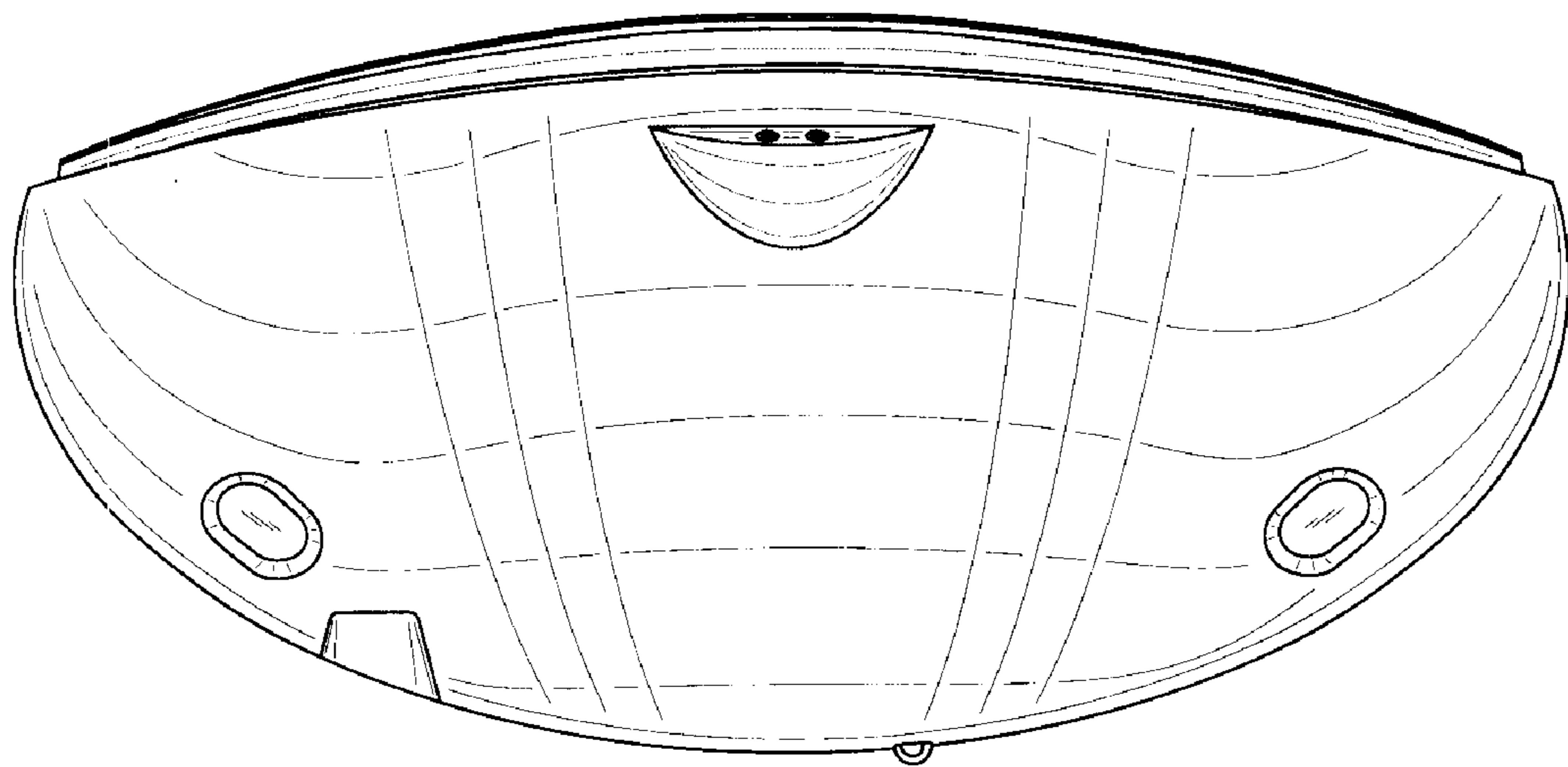

FIG. 7