

US00D526868S

(12) **United States Design Patent**  
**Robson**

(10) **Patent No.:** **US D526,868 S**

(45) **Date of Patent:** **\*\* Aug. 22, 2006**

(54) **SANDER**

(75) Inventor: **Nigel Robson**, Gateshead (GB)

(73) Assignee: **Black & Decker Inc.**, Newark, DE (US)

(\*\*) Term: **14 Years**

(21) Appl. No.: **29/217,935**

(22) Filed: **Nov. 23, 2004**

(51) **LOC (8) Cl.** ..... **08-01**

(52) **U.S. Cl.** ..... **D8/62**

(58) **Field of Classification Search** ..... D8/67,  
D8/62, 61; D32/15, 17, 19, 50; D4/102; 451/359,  
451/358, 357, 356, 355, 354, 353, 351, 344,  
451/456, 451

See application file for complete search history.

(56) **References Cited**

U.S. PATENT DOCUMENTS

D355,105 S	2/1995	Nemazi	
D366,406 S	1/1996	Kikuchi	
D374,386 S	10/1996	Bosten et al.	
D380,950 S	7/1997	Gildersleeve et al.	
D392,861 S	3/1998	Gildersleeve et al.	
D404,273 S	1/1999	Somers	
D413,242 S	* 8/1999	Robson	D8/62
D413,245 S	* 8/1999	Robson	D8/70
D435,768 S	1/2001	Duffy	
6,179,696 B1	1/2001	Duffy	
D447,397 S	* 9/2001	Netzler	D8/62

D453,460 S	* 2/2002	Lui	D8/62
D509,720 S	* 9/2005	Robson	D8/62
2004/0078936 A1	* 4/2004	Walker et al.	16/430
2006/0003680 A1	* 1/2006	Robson	451/357

\* cited by examiner

*Primary Examiner*—Cathron C. Brooks

*Assistant Examiner*—Austin Murphy

(74) *Attorney, Agent, or Firm*—Bruce S. Shapiro; Wesley W. Muller; John Yun

(57) **CLAIM**

The ornamental design for a sander, as shown and described.

**DESCRIPTION**

FIG. 1 is a front/left perspective view of the first embodiment of a sander.

FIG. 2 is a left side elevational view thereof.

FIG. 3 is a right side elevational view thereof.

FIG. 4 is a front view thereof.

FIG. 5 is a rear view thereof.

FIG. 6 is a top elevational view thereof.

FIG. 7 is a bottom elevational view thereof.

FIG. 8 is a front/left perspective view of the second embodiment of a sander.

FIG. 9 is a left side elevational view thereof.

FIG. 10 is a right side elevational view thereof.

FIG. 11 is a front view thereof.

FIG. 12 is a rear view thereof.

FIG. 13 is a top elevational view thereof; and,

FIG. 14 is a bottom elevational view thereof.

**1 Claim, 12 Drawing Sheets**

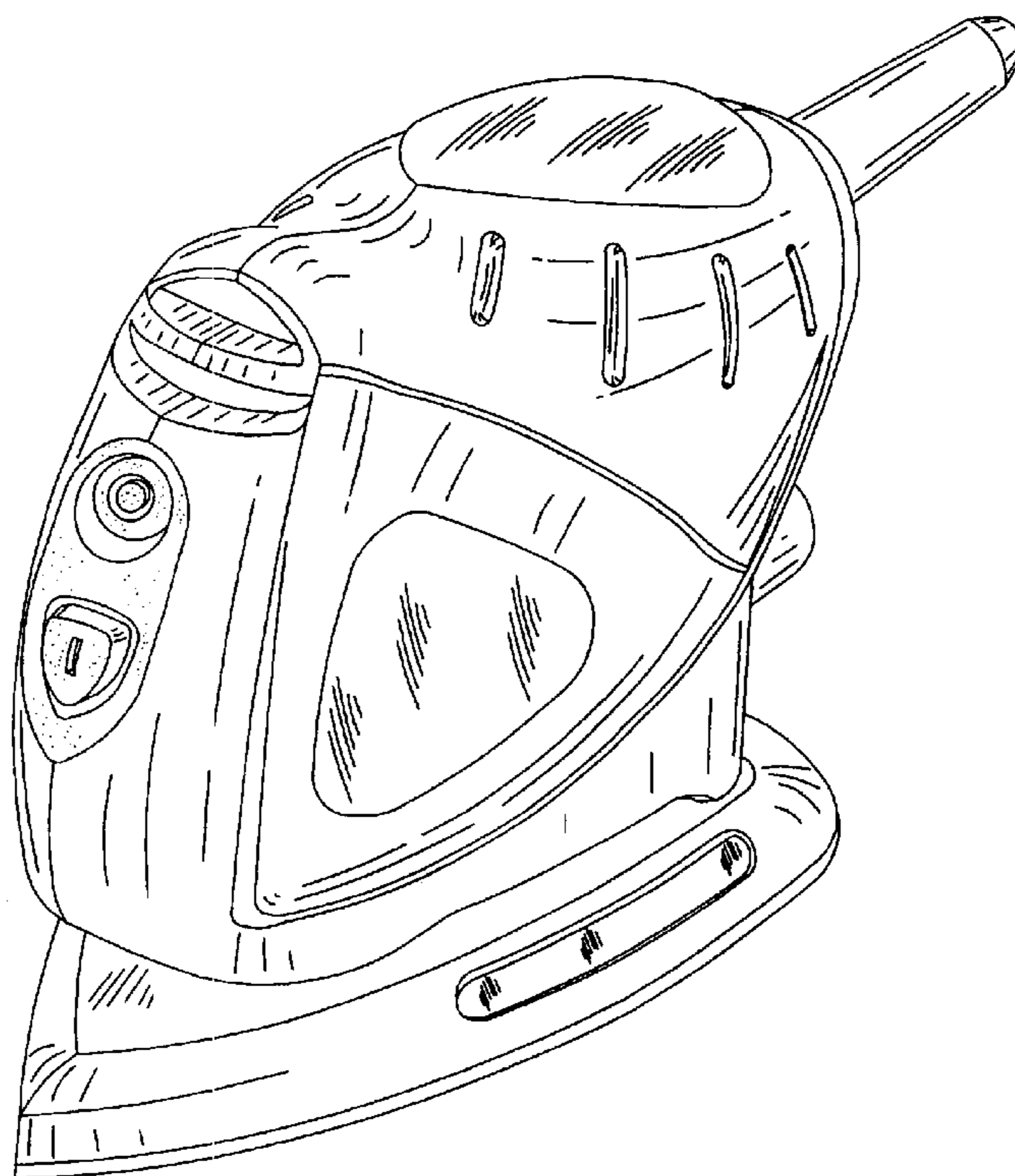

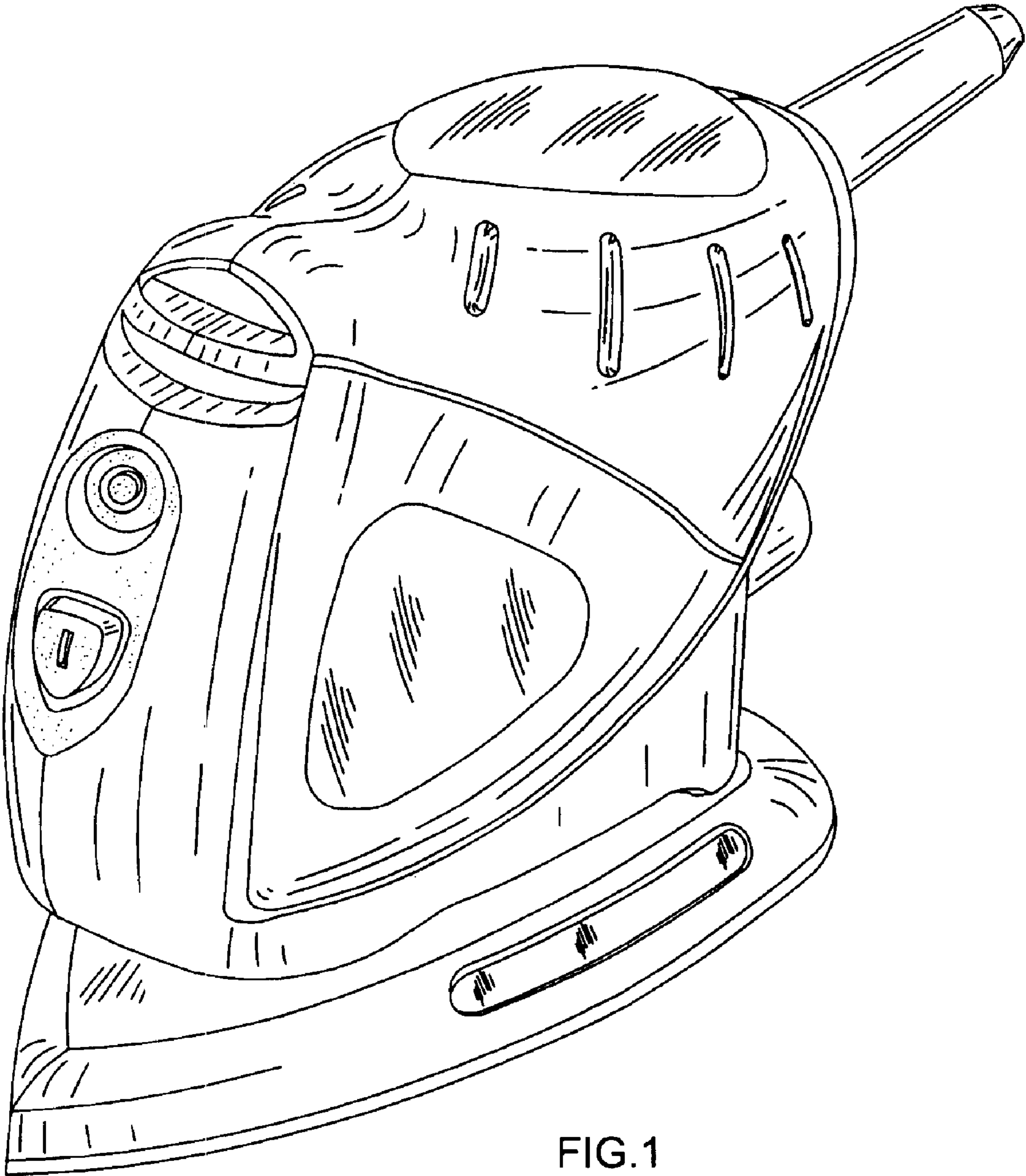

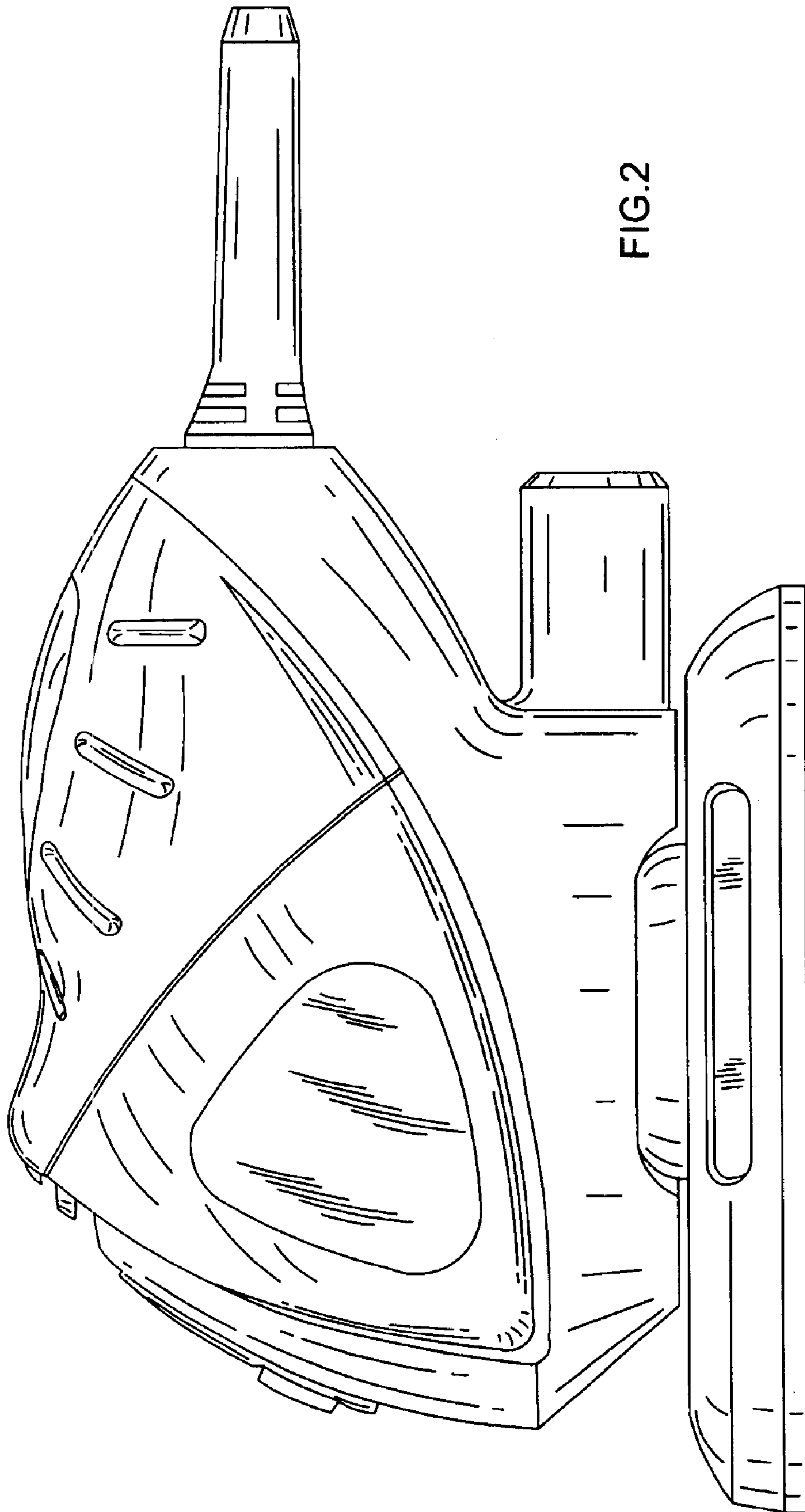

FIG. 2

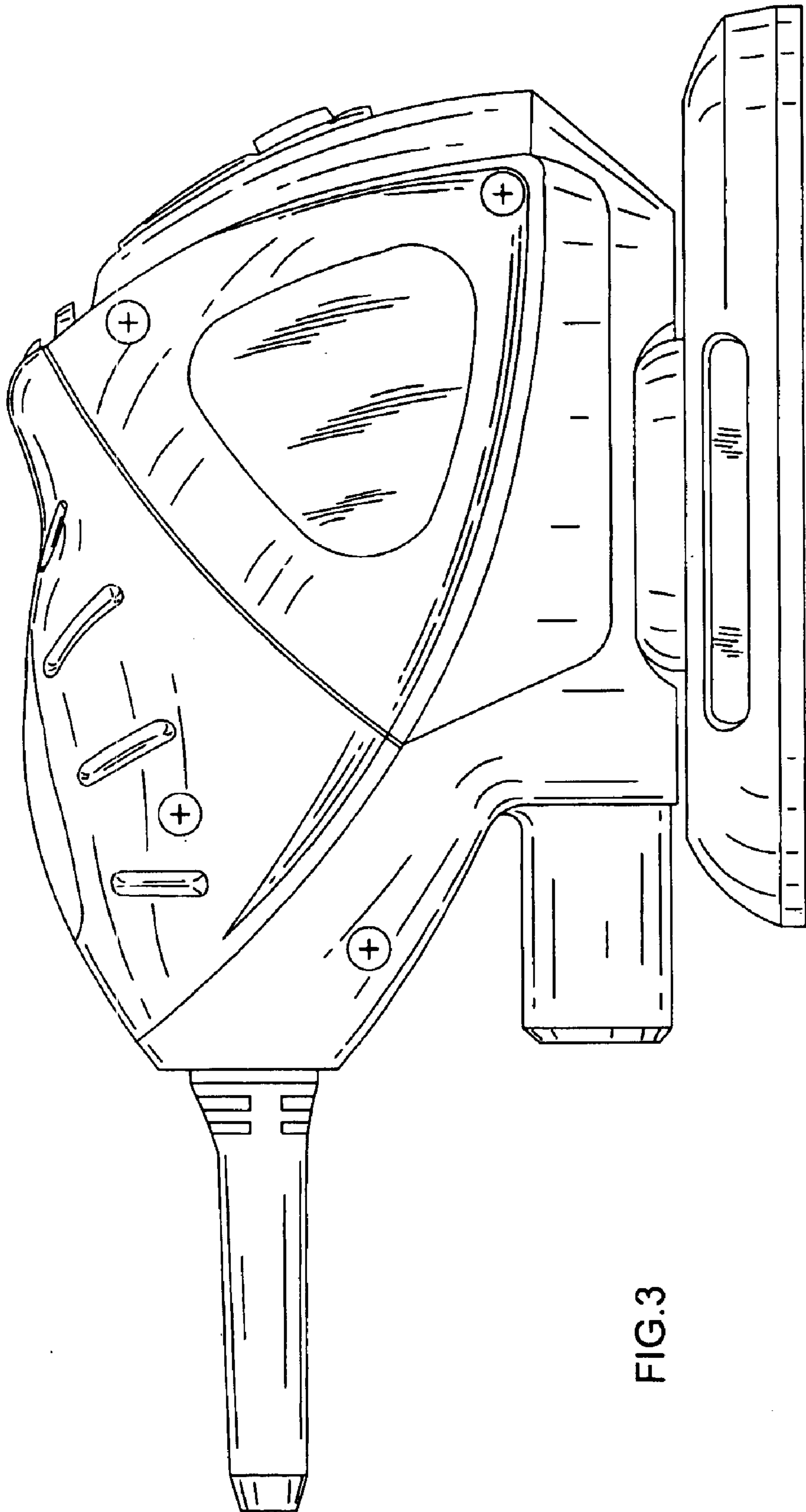

FIG.3

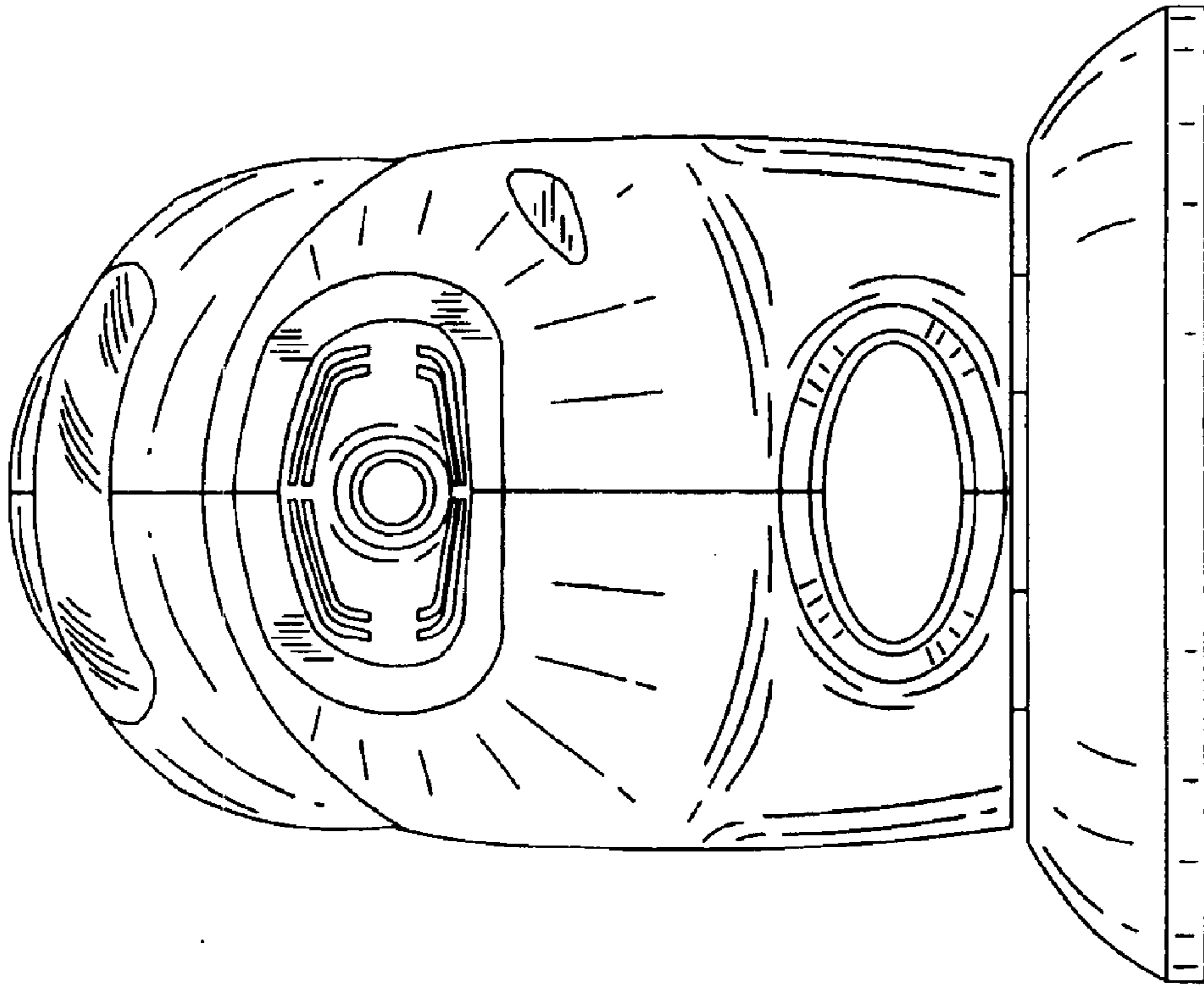

FIG.5

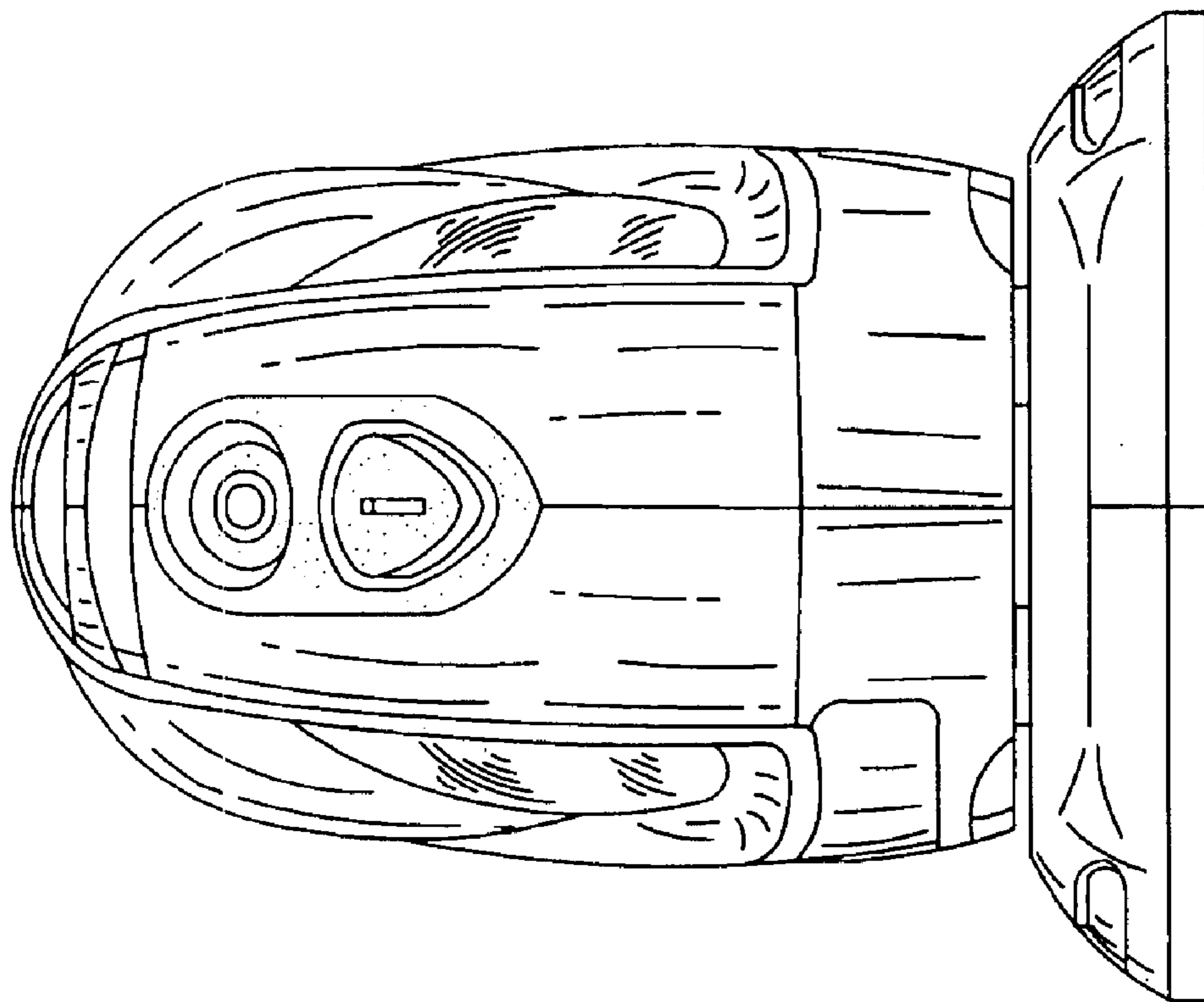

FIG.4

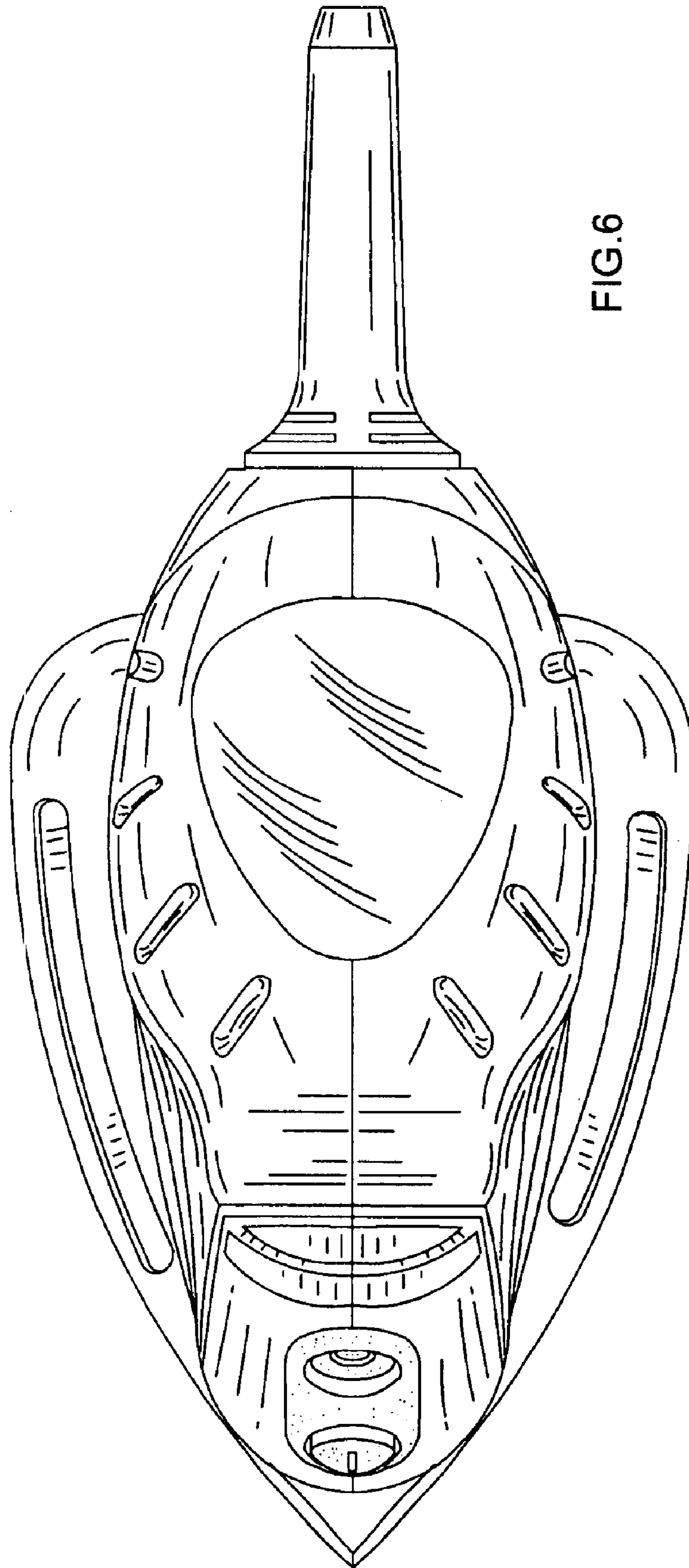

FIG. 6

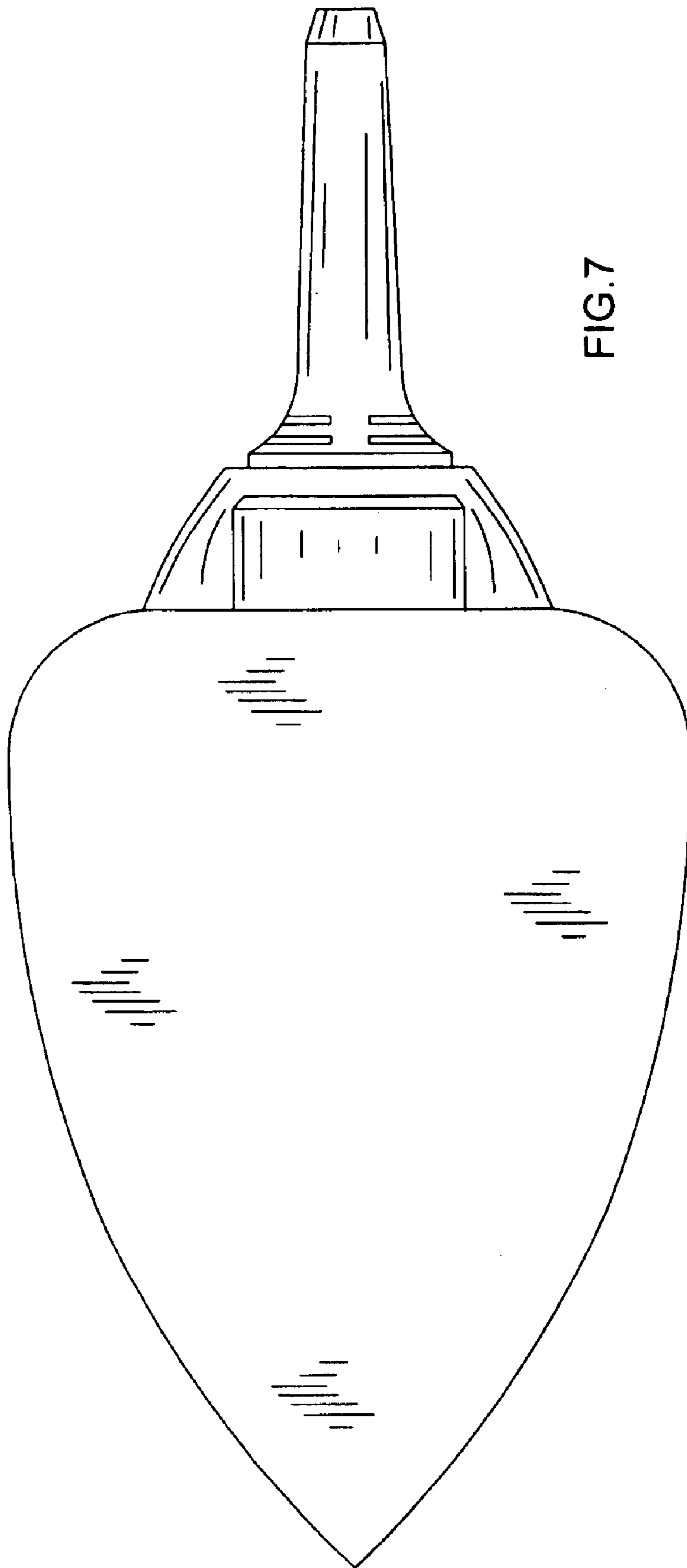

FIG. 7

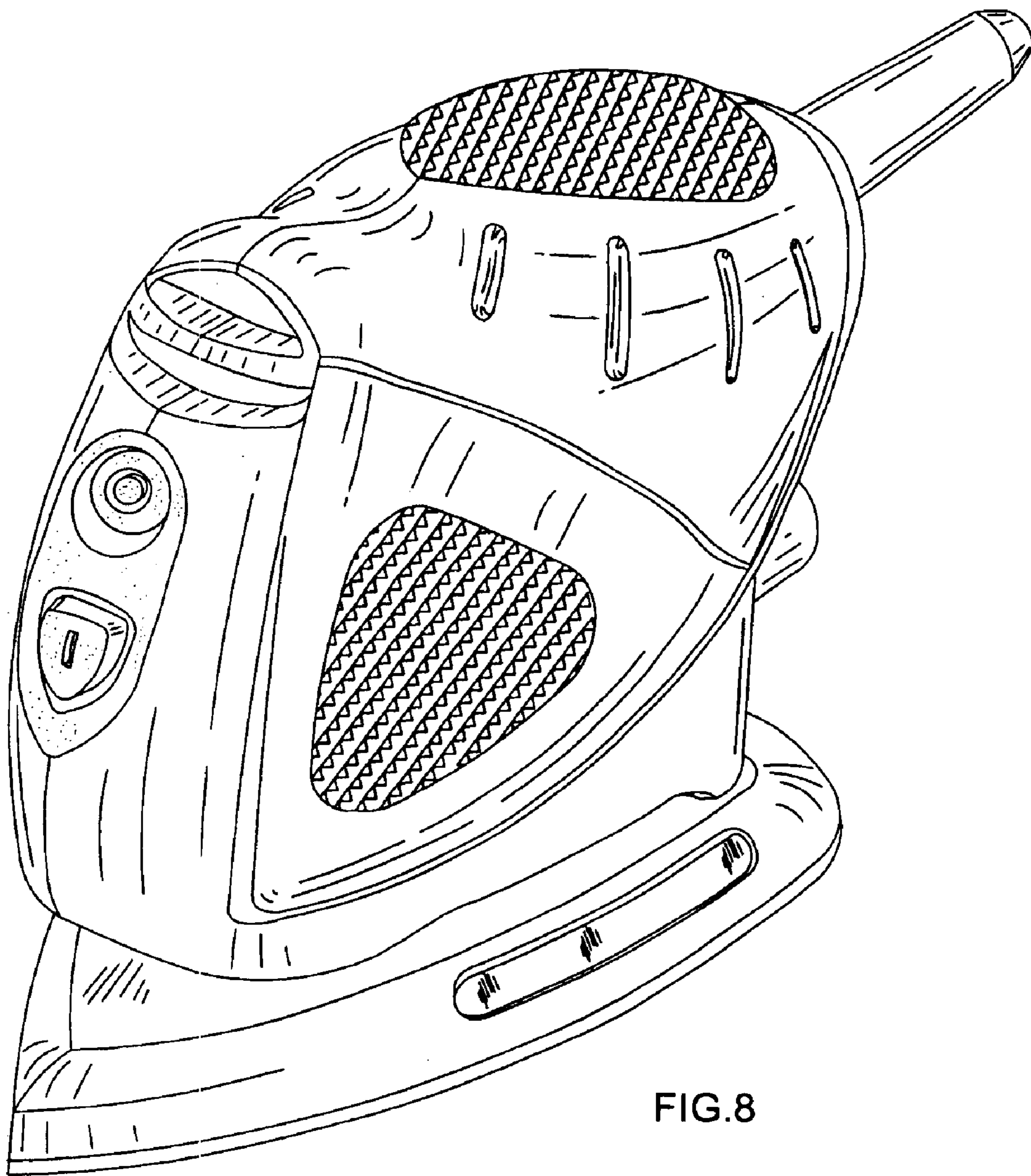

FIG. 8



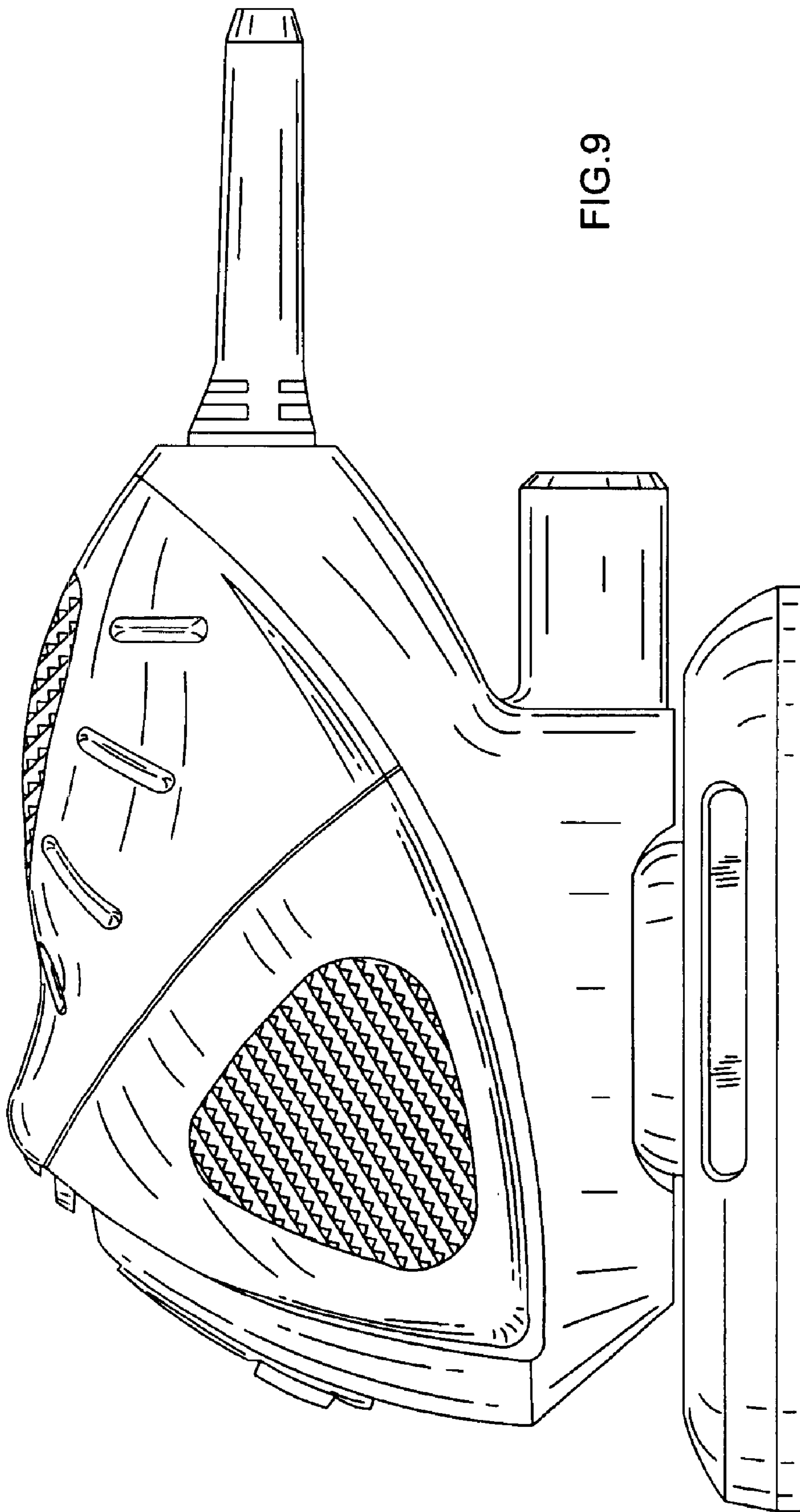

FIG.9

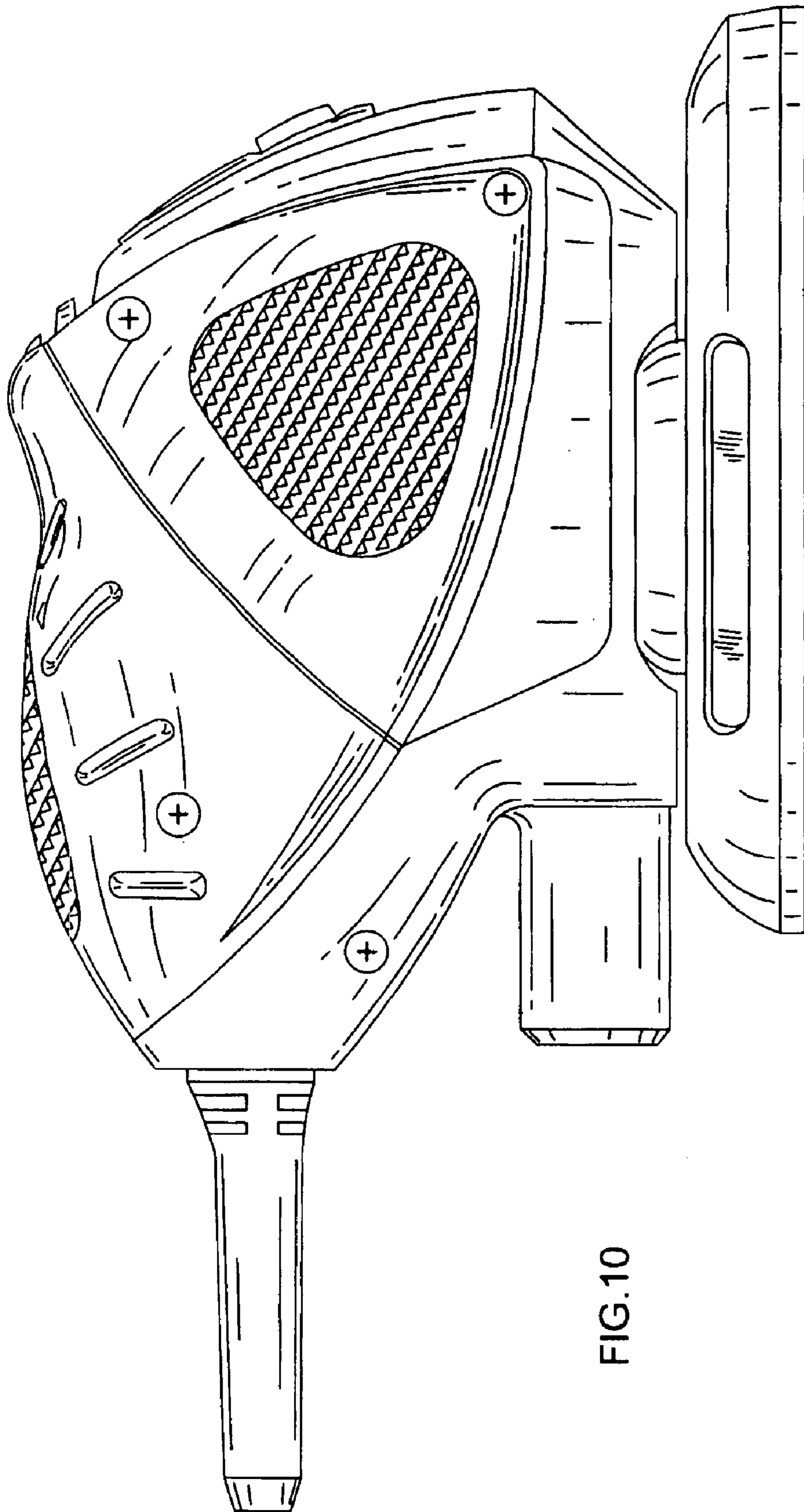

FIG.10

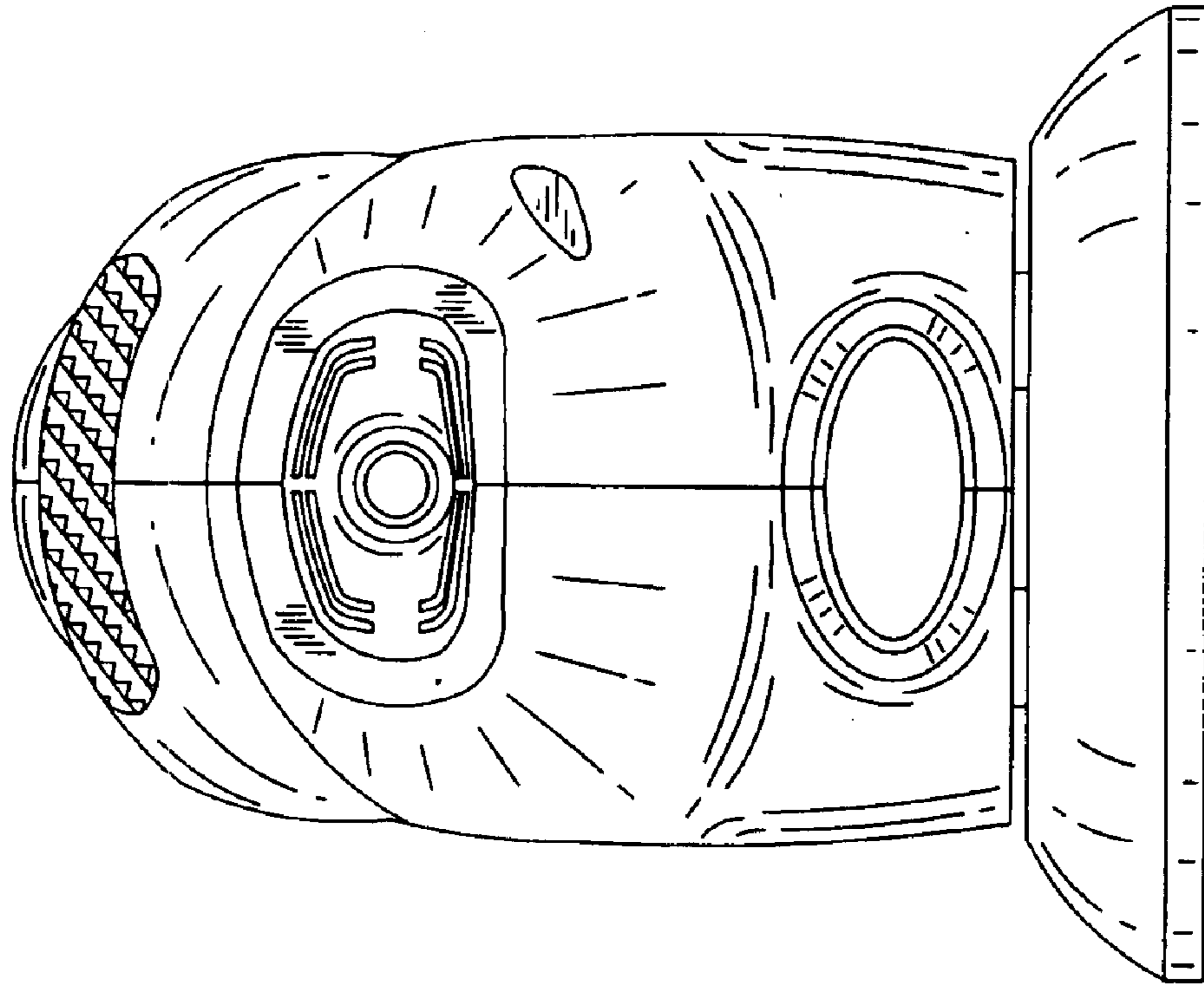

FIG.11

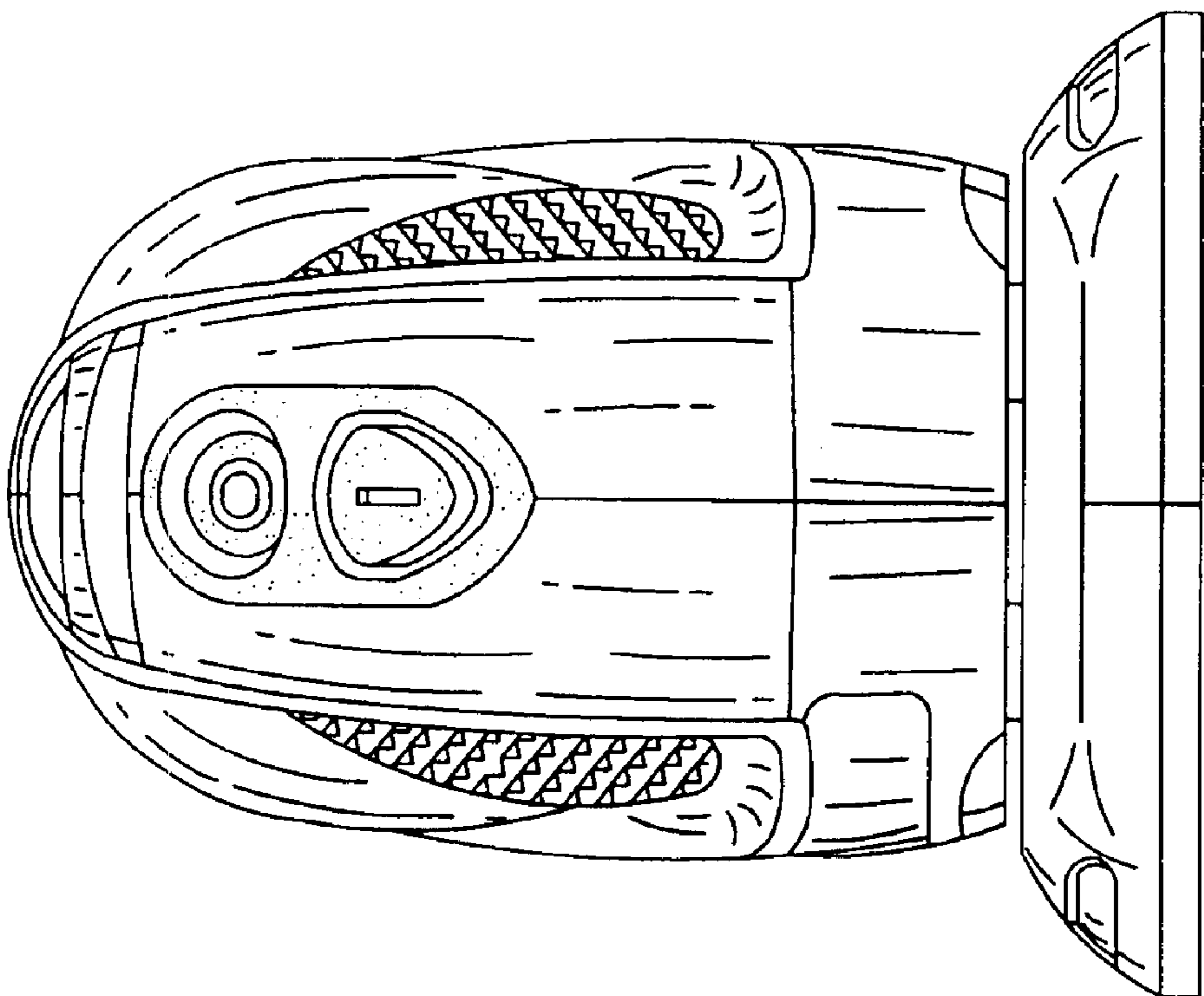

FIG.12

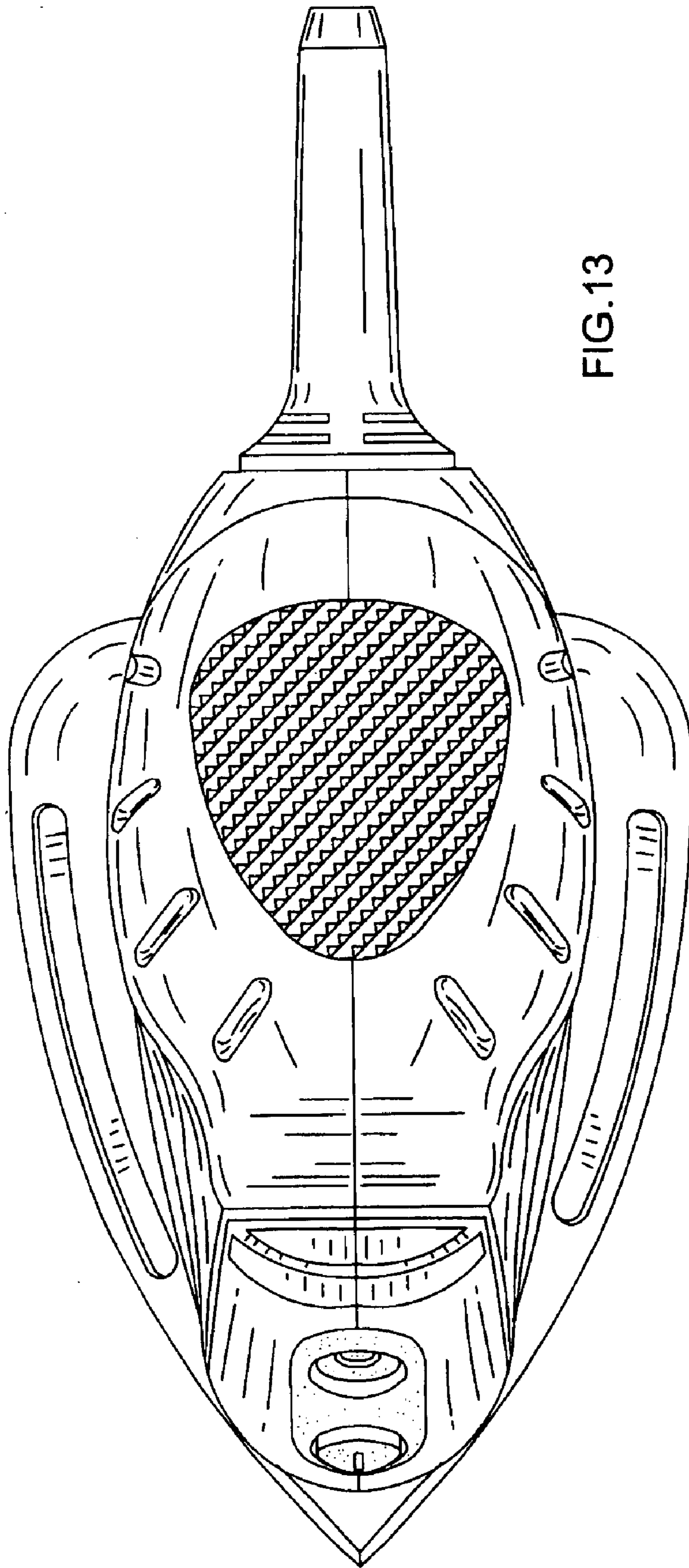

FIG.13

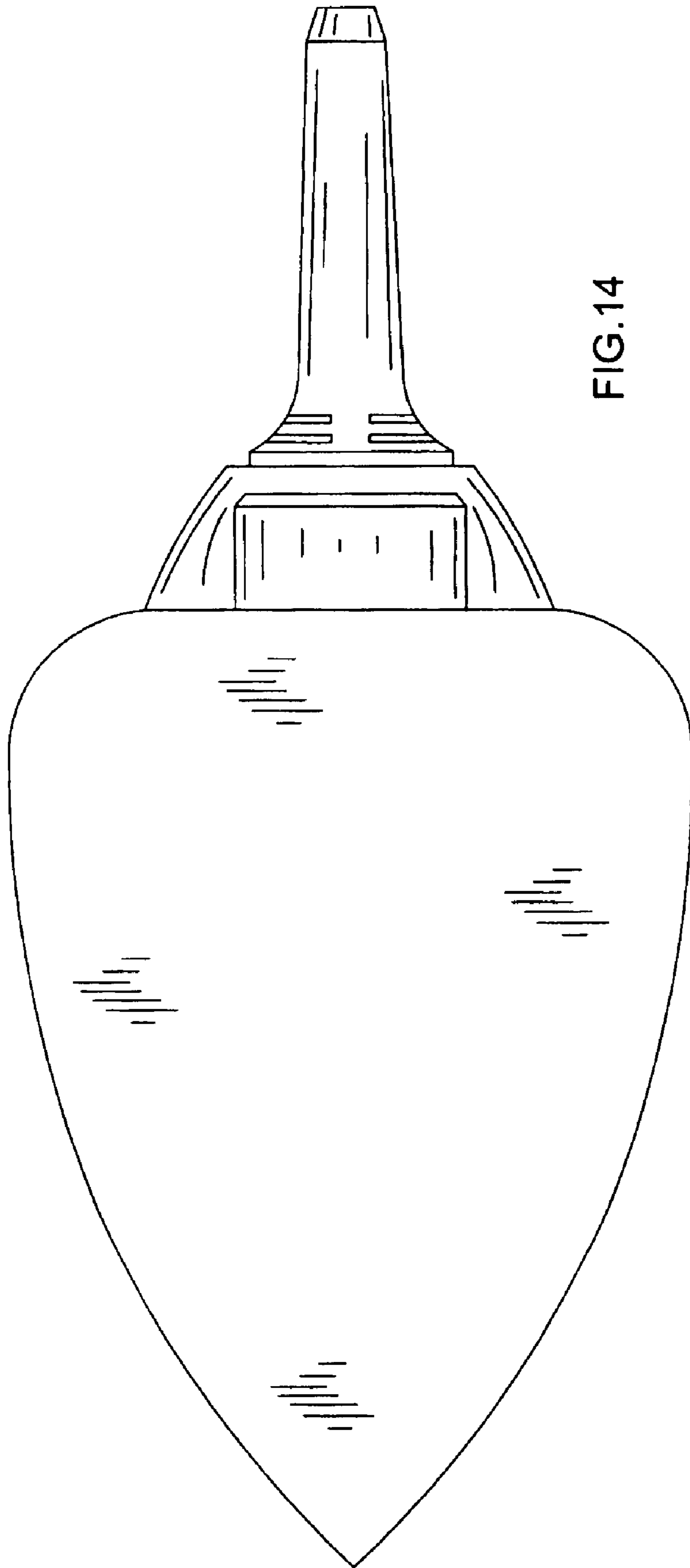

FIG.14