



US00D526761S

(12) **United States Design Patent**
Hoffman

(10) **Patent No.:** **US D526,761 S**

(45) **Date of Patent:** **** Aug. 22, 2006**

(54) **CANDY NOVELTY**

(75) Inventor: **Harry Hoffman**, Wynnewood, PA (US)

(73) Assignee: **Frankford Candy & Chocolate Co.**,
Philadelphia, PA (US)

(**) Term: **14 Years**

(21) Appl. No.: **29/207,559**

(22) Filed: **Jun. 15, 2004**

(51) **LOC (8) Cl.** **01-01**

(52) **U.S. Cl.** **D1/104; D1/102**

(58) **Field of Classification Search** D1/101-2,
D1/105-6, 116, 118, 199; 426/104, 110, 112,
426/134; 206/457, 223, 541-2; 220/526;
215/306; 222/556; D9/446, 560; D27/141,
D27/144, 148, 154-5, 160-1

See application file for complete search history.

(56) **References Cited**

U.S. PATENT DOCUMENTS

2,310,271	A	*	2/1943	Ziehmer, Jr.	222/480
3,094,244	A	*	6/1963	White	222/23
3,872,996	A	*	3/1975	Dogliotti	220/254.7
4,925,033	A	*	5/1990	Stoner	206/581
D351,105	S	*	10/1994	Grip	D9/529
5,482,172	A	*	1/1996	Braddock	215/235
D371,674	S	*	7/1996	Williams	D3/215
5,715,969	A	*	2/1998	Seerup et al.	220/503
D403,579	S	*	1/1999	Gallart et al.	D9/418
D457,426	S	*	5/2002	Montana	D9/420
6,491,158	B1	*	12/2002	Chen	206/5
D477,999	S	*	8/2003	Lloyd	D9/414
D498,331	S	*	11/2004	Cohen Harel	D27/157

* cited by examiner

Primary Examiner—Robin Webster

Assistant Examiner—Karen E. Patterson

(74) *Attorney, Agent, or Firm*—Woodcock Washburn LLP

(57) **CLAIM**

An ornamental design for a candy novelty, as shown and described.

DESCRIPTION

FIG. 1 is a front perspective view of a candy novelty;
 FIG. 2 is a front elevational view of the candy novelty shown in FIG. 1;
 FIG. 3 is a left side elevational view of the candy novelty shown in FIG. 1;
 FIG. 4 is a top plan view of the candy novelty shown in FIG. 1;
 FIG. 5 is a rear elevational view of the candy novelty shown in FIG. 1;
 FIG. 6 is a right side elevational view of the candy novelty shown in FIG. 1;
 FIG. 7 is a bottom plan view of the candy novelty shown in FIG. 1;
 FIG. 8 is a left side elevational view of a second embodiment of a candy novelty;
 FIG. 9 is a right side elevational view of the candy novelty shown in FIG. 8;
 FIG. 10 is a rear elevational view of the candy novelty shown in FIG. 8;
 FIG. 11 is a bottom plan view of the candy novelty shown in FIG. 8;
 FIG. 12 is a front perspective view of a third embodiment of a candy novelty;
 FIG. 13 is a front elevational view of the candy novelty shown in FIG. 12;
 FIG. 14 is a left side elevational view of the candy novelty shown in FIG. 12;
 FIG. 15 is a top plan view of the candy novelty shown in FIG. 12;
 FIG. 16 is a rear elevational view of the candy novelty shown in FIG. 12; and,
 FIG. 17 is a right side elevational view of the candy novelty shown in FIG. 12.

The dashed lines shown in the views are for illustrative purposes only and form no part of the claimed design, the dashed lines simply demonstrating that a drawing or figure could be placed on, or inserted in, the particular embodiment of the candy novelty.

1 Claim, 7 Drawing Sheets

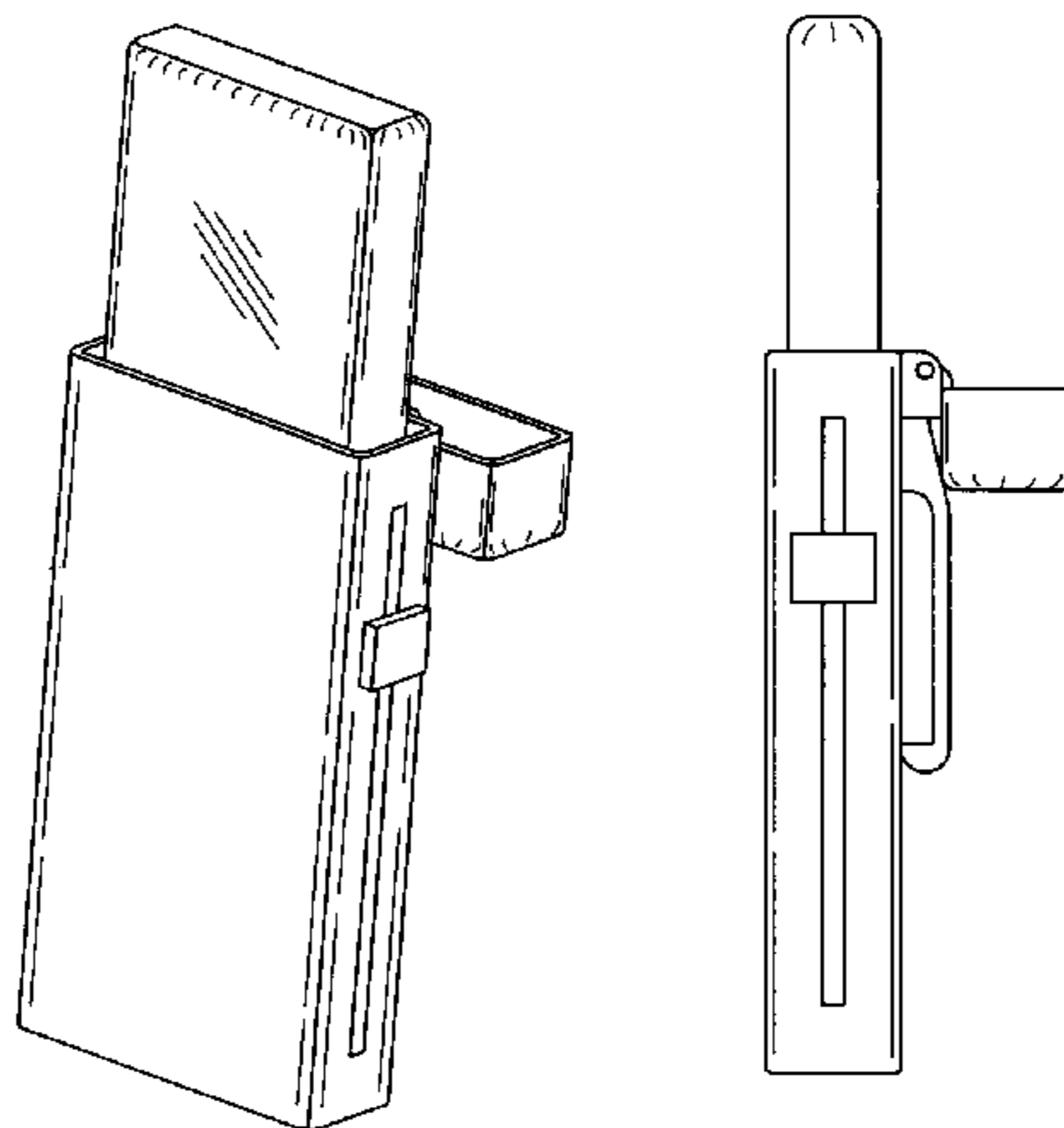

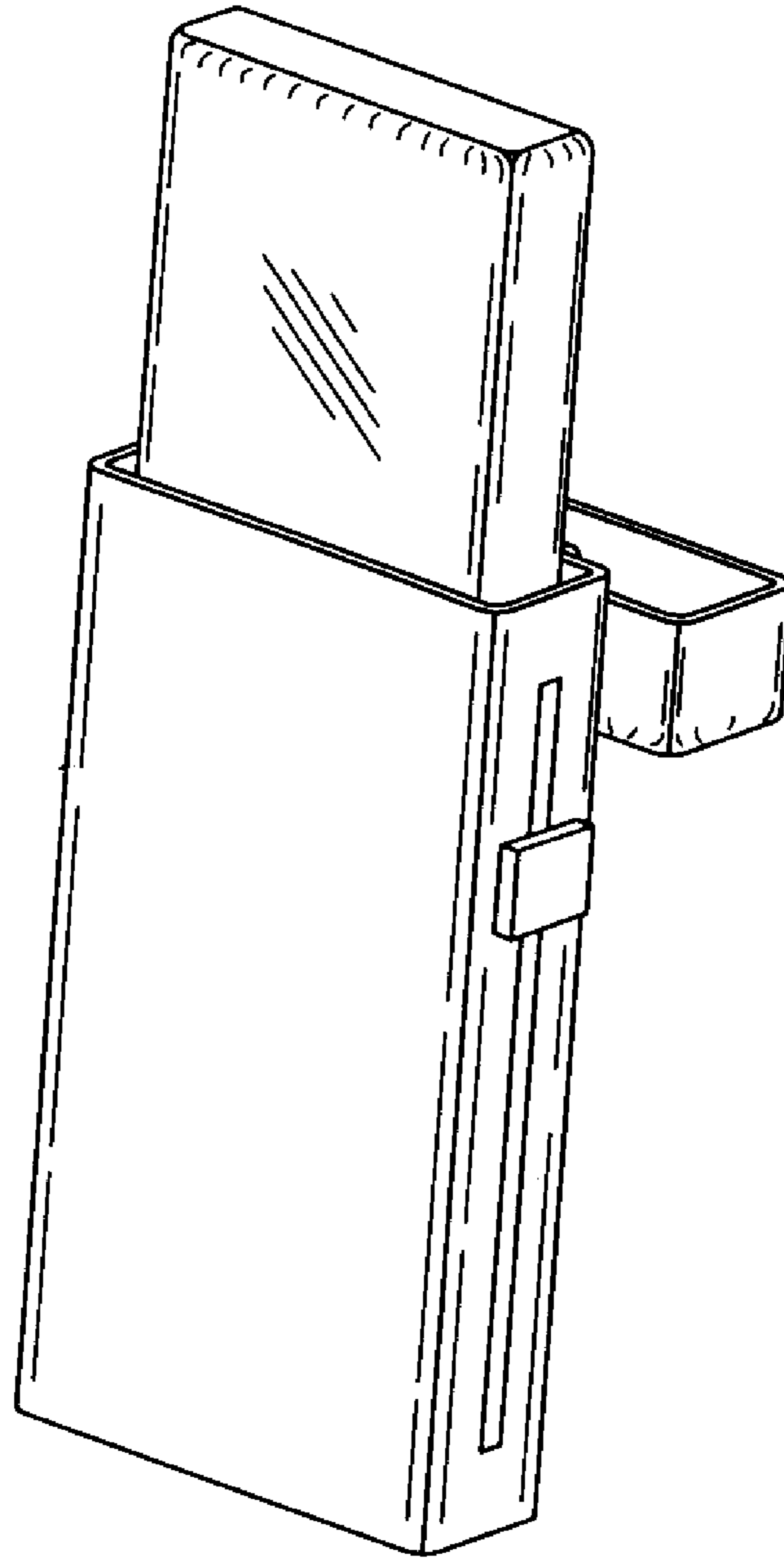

Fig. 1

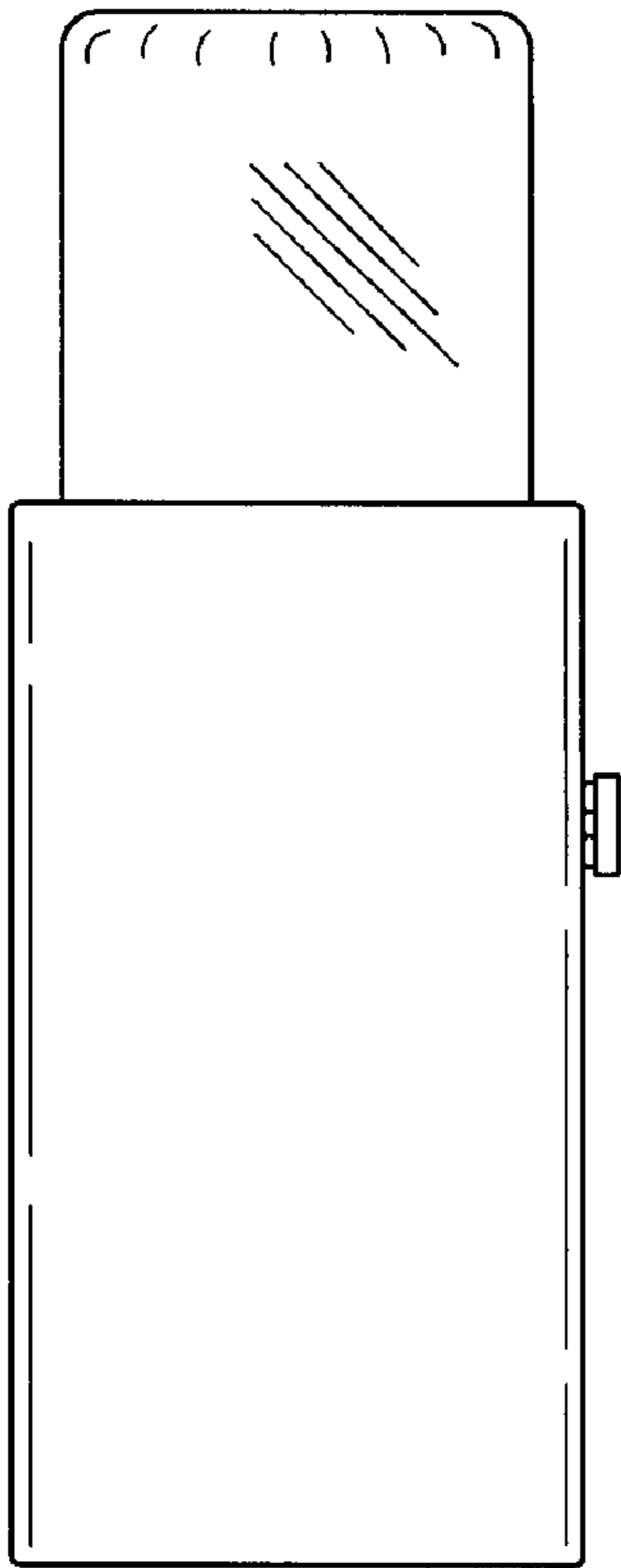

Fig. 2

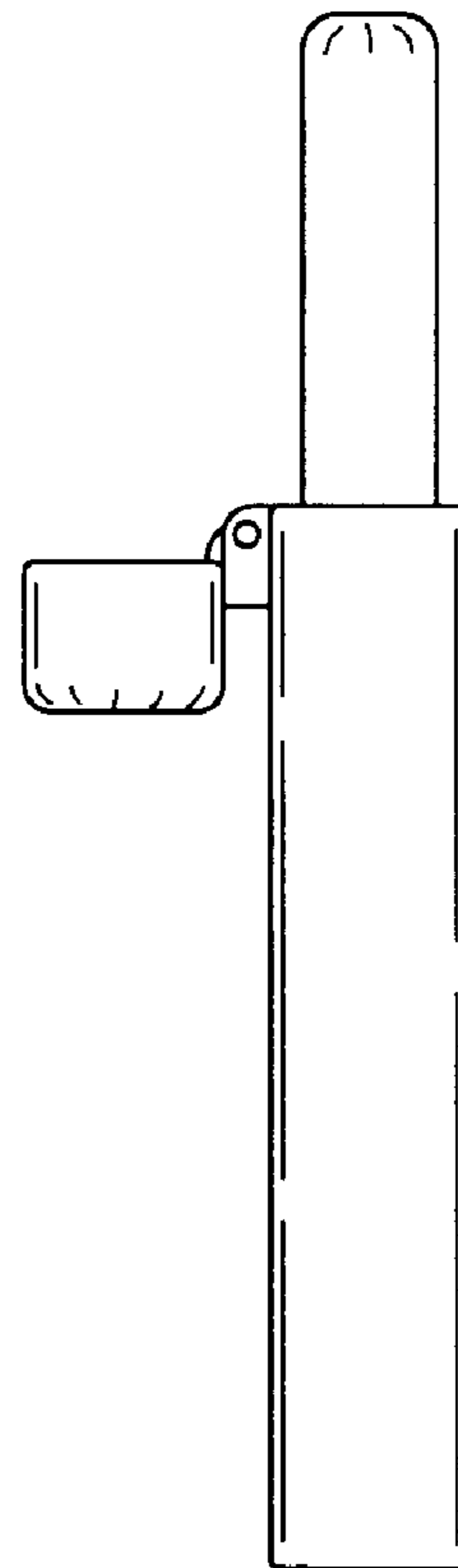

Fig. 3

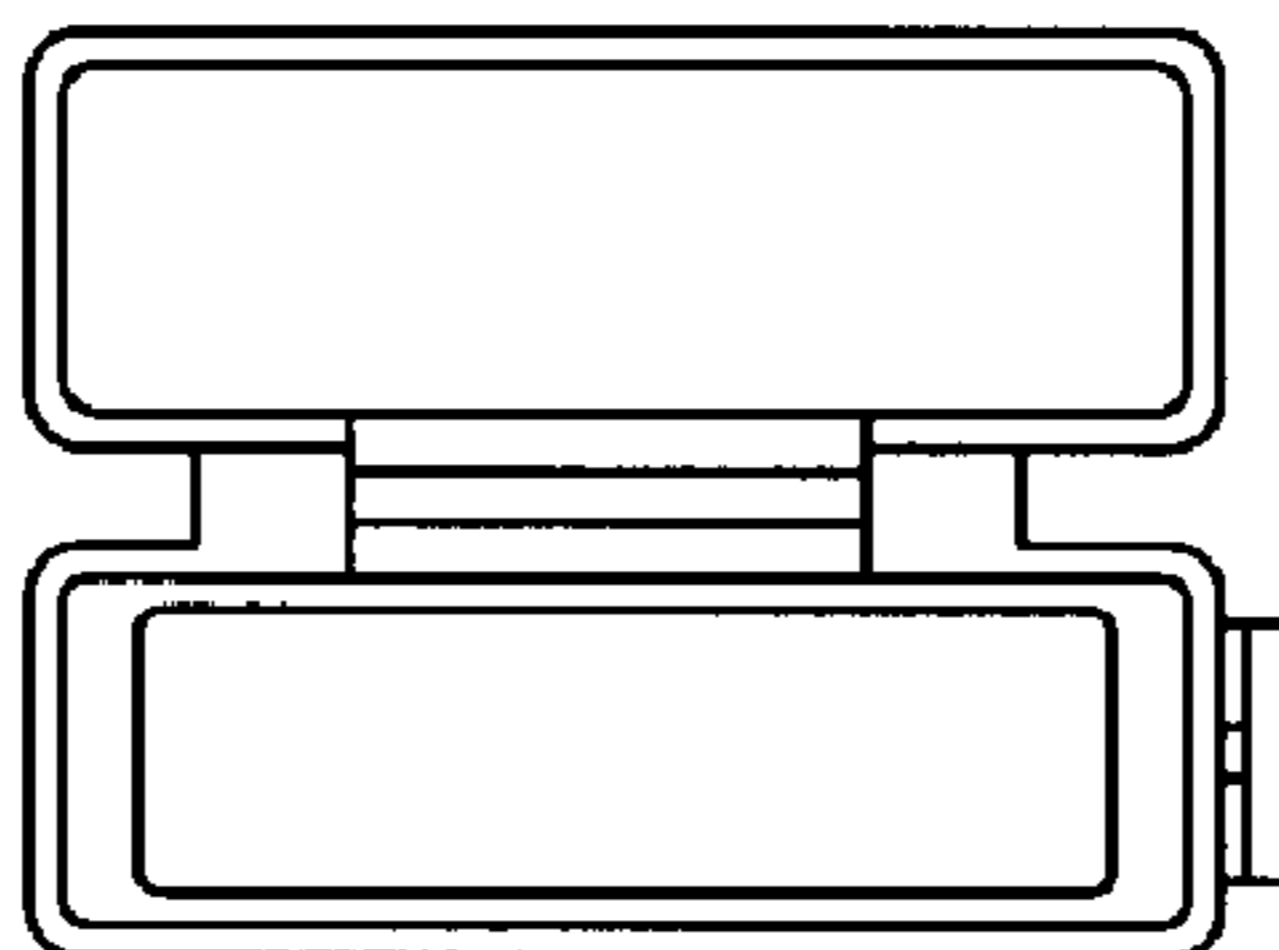

Fig. 4

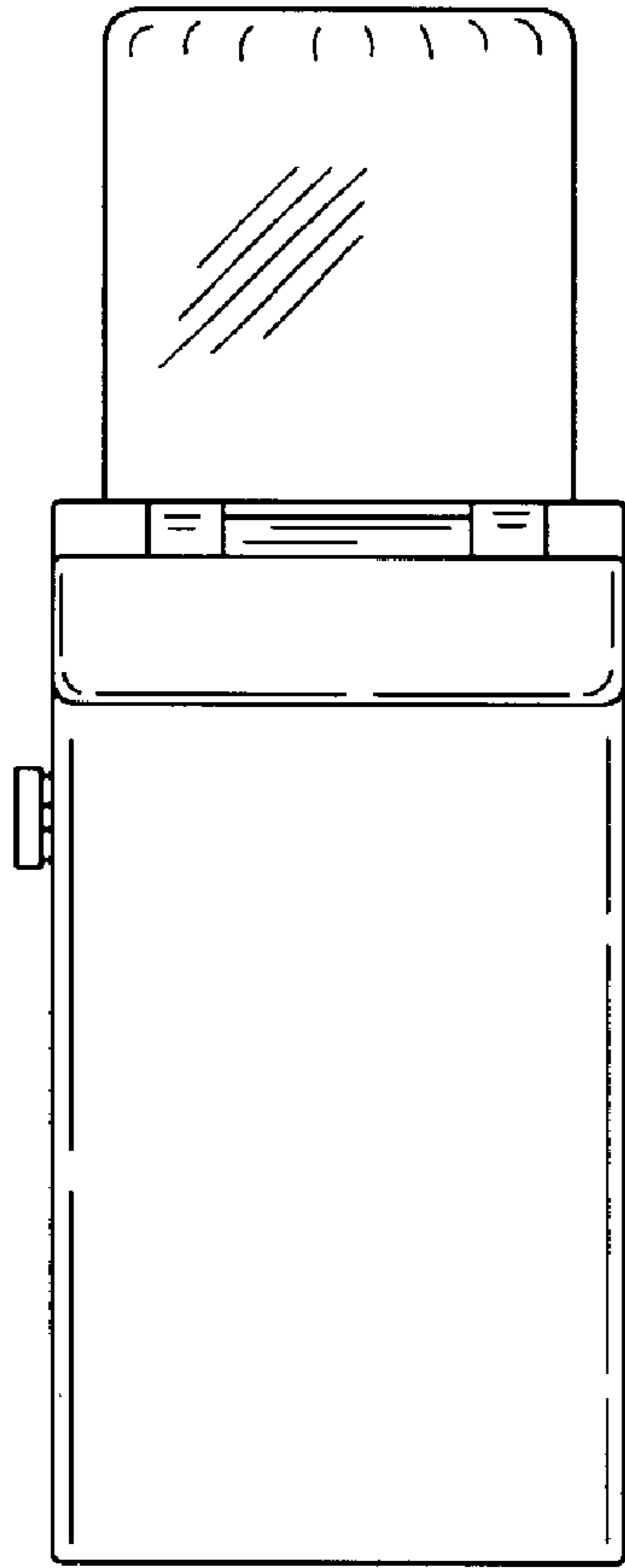

Fig. 5

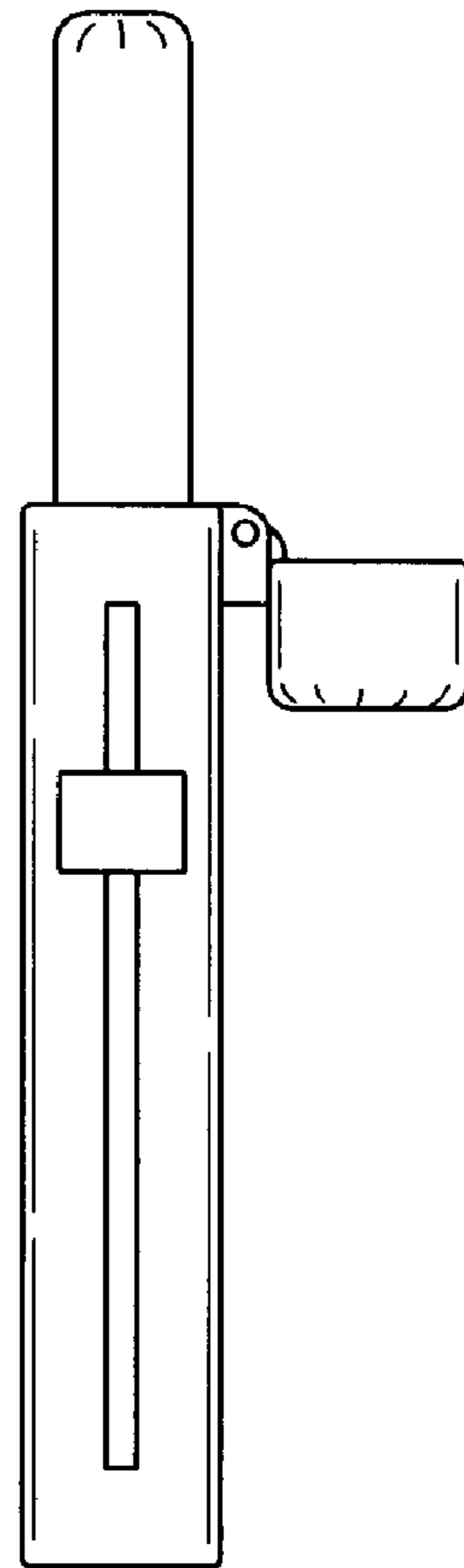

Fig. 6

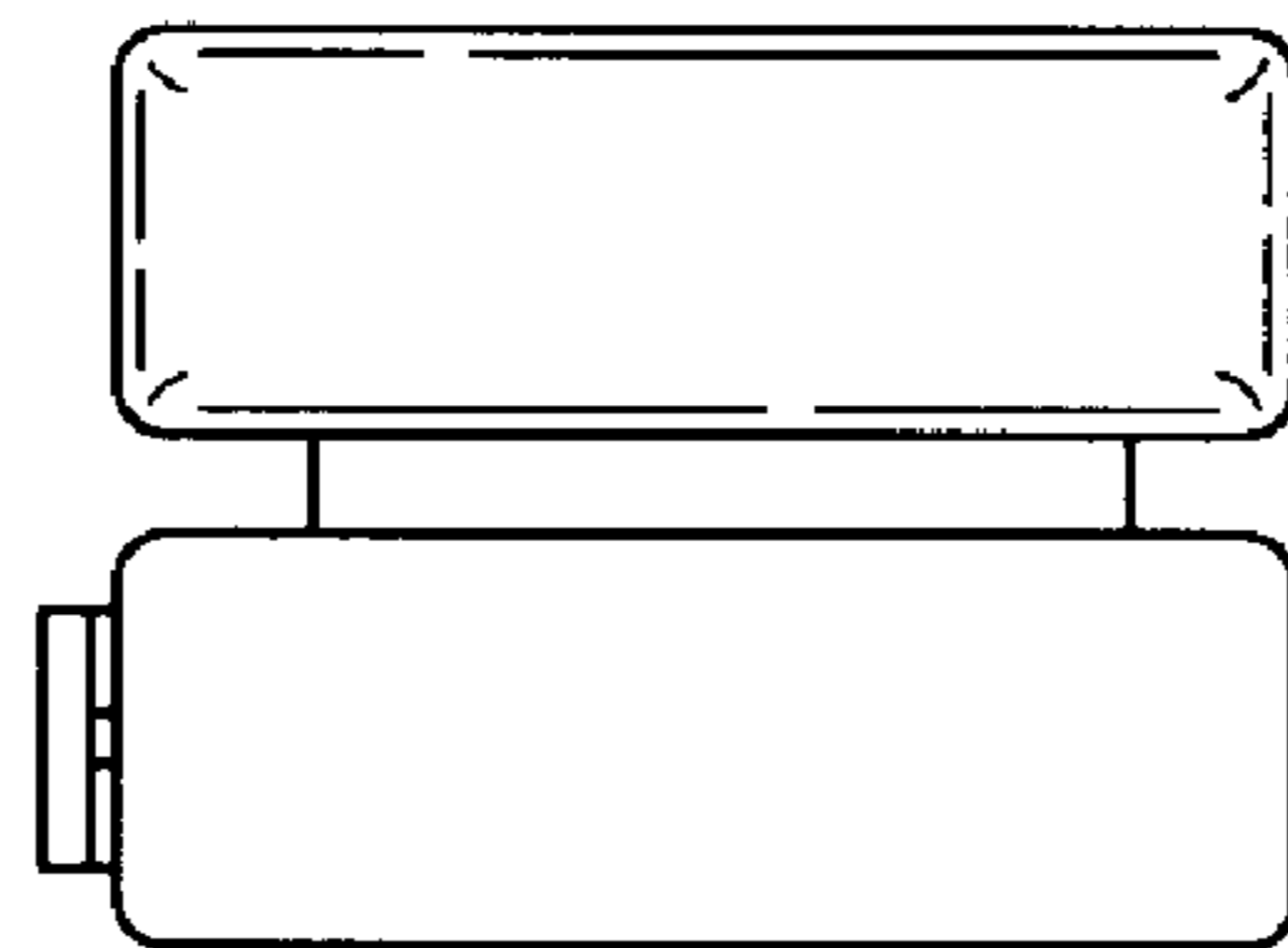

Fig. 7

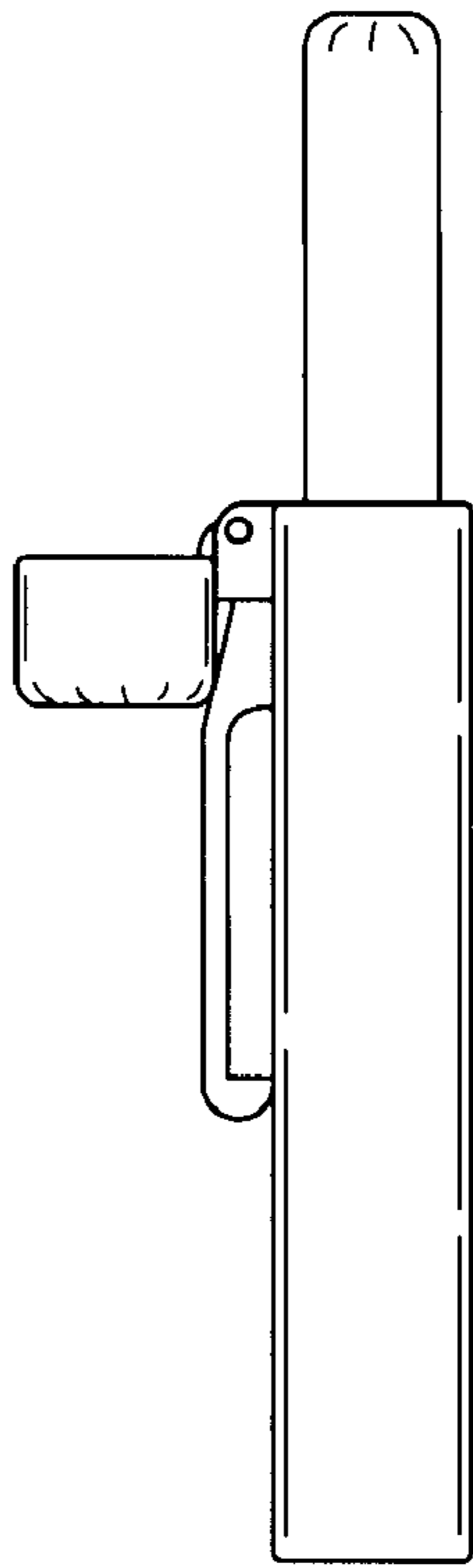

Fig. 8

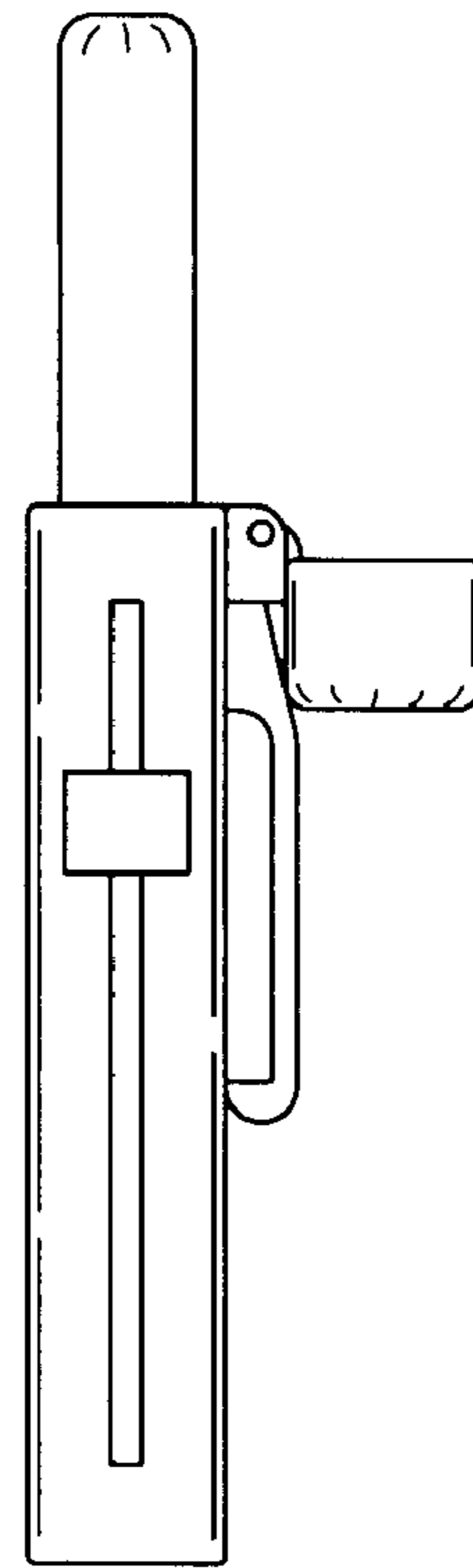

Fig. 9

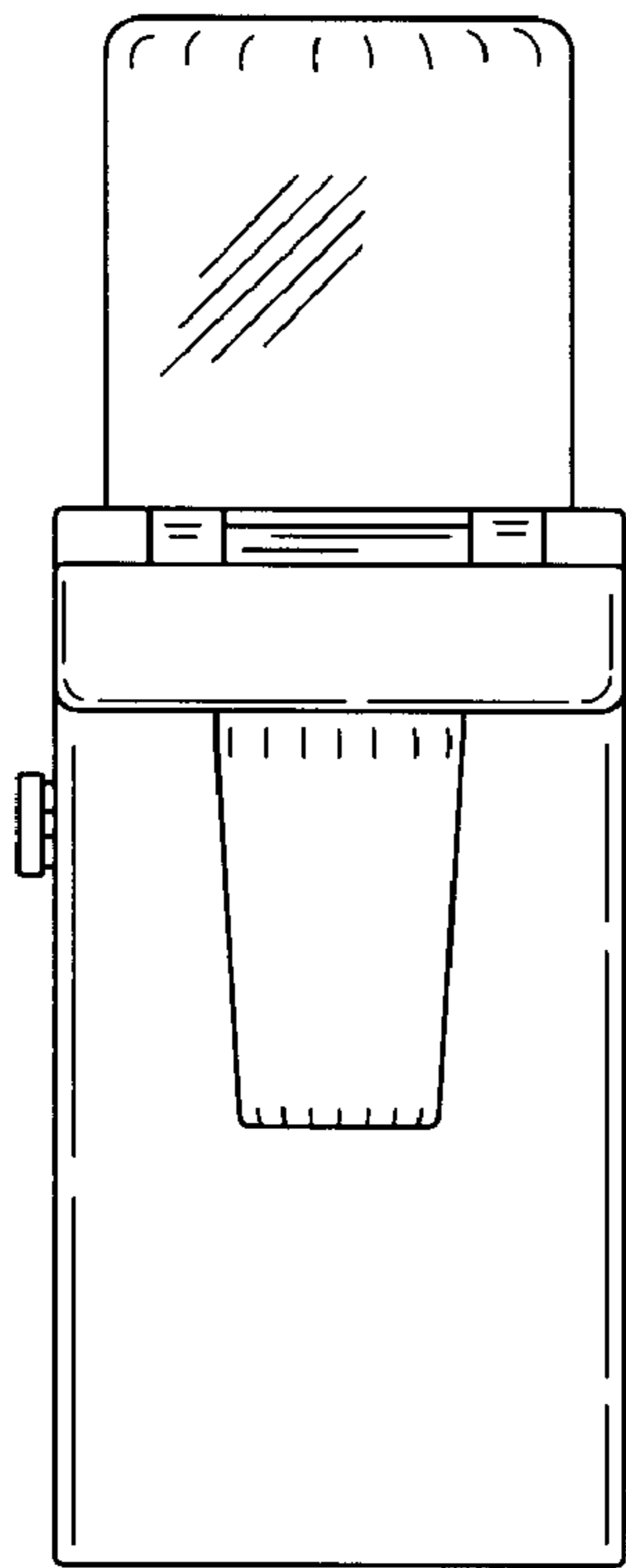

Fig. 10

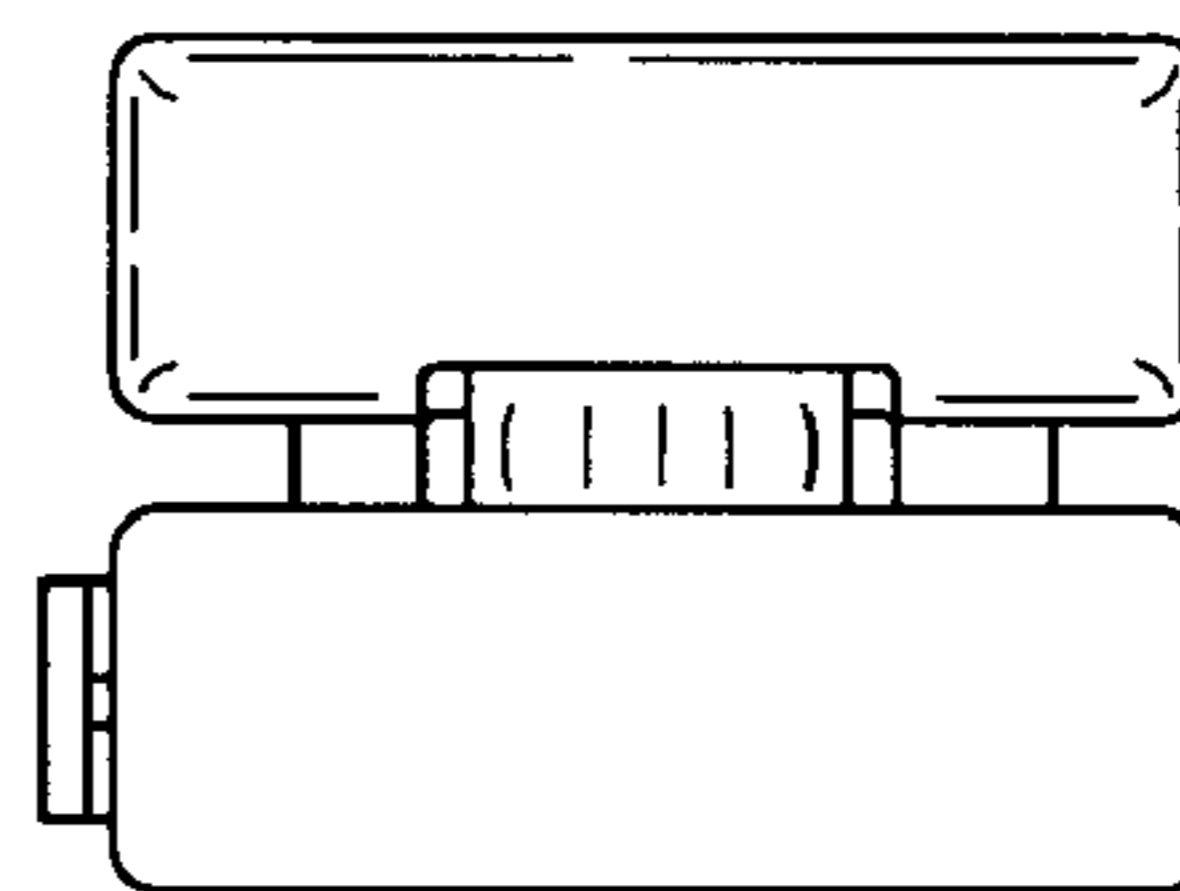

Fig. 11

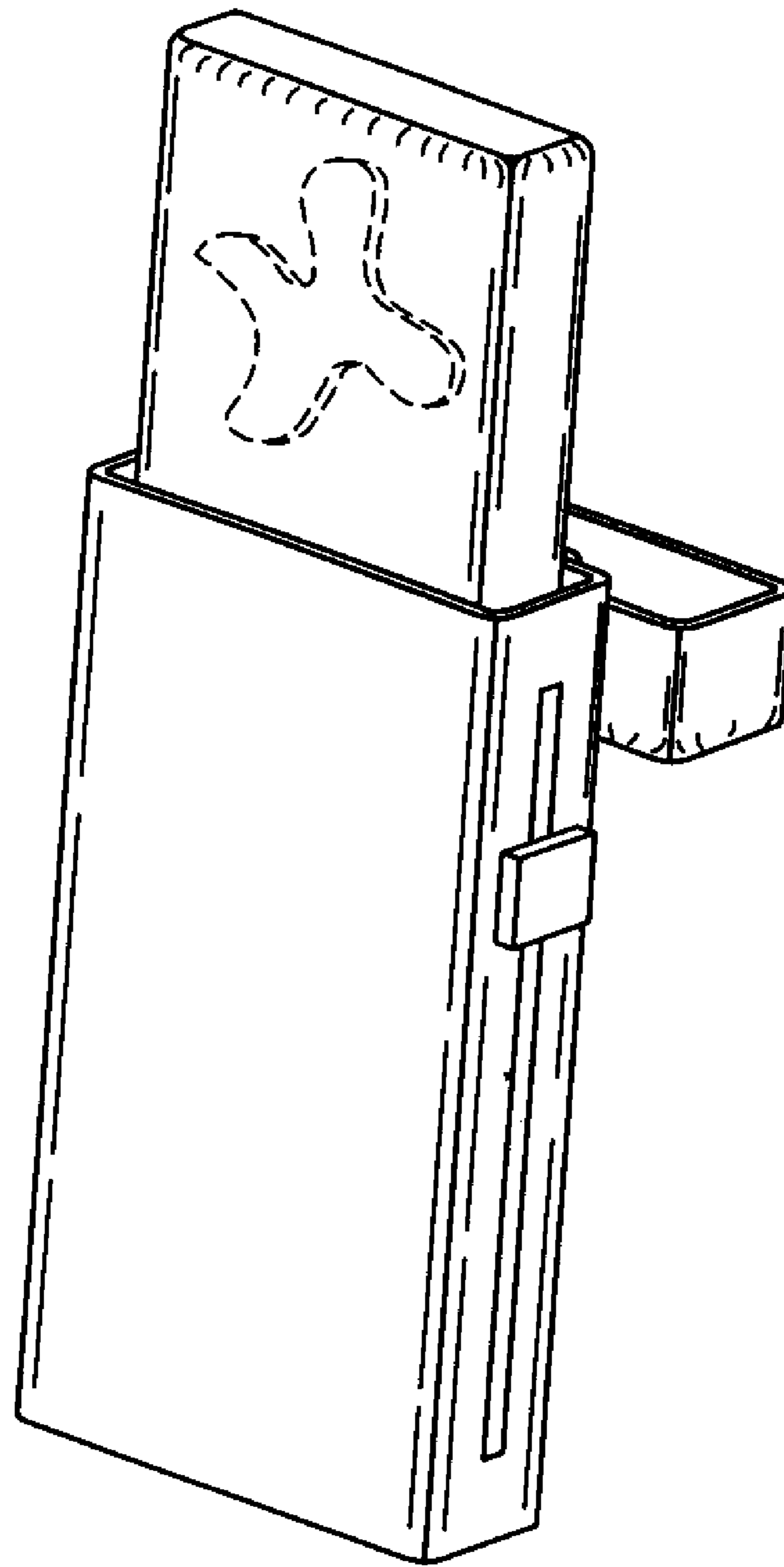

Fig. 12

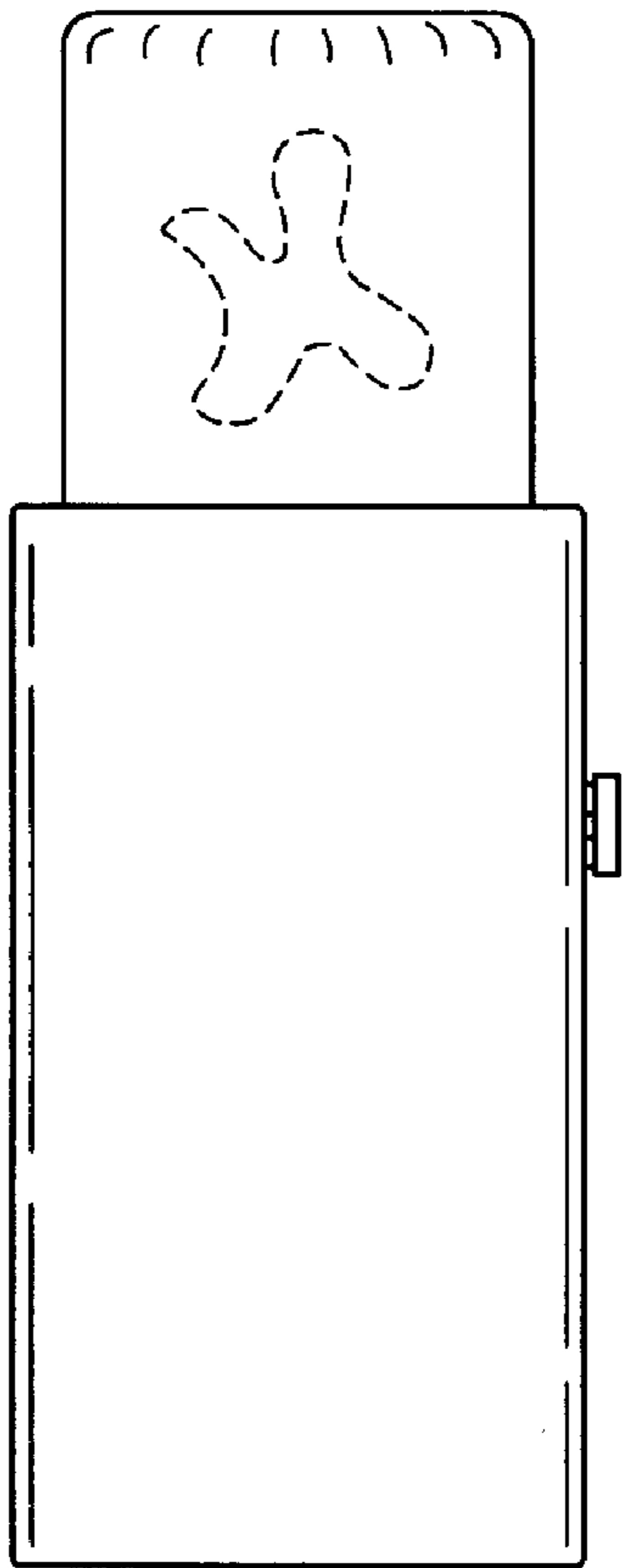

Fig. 13

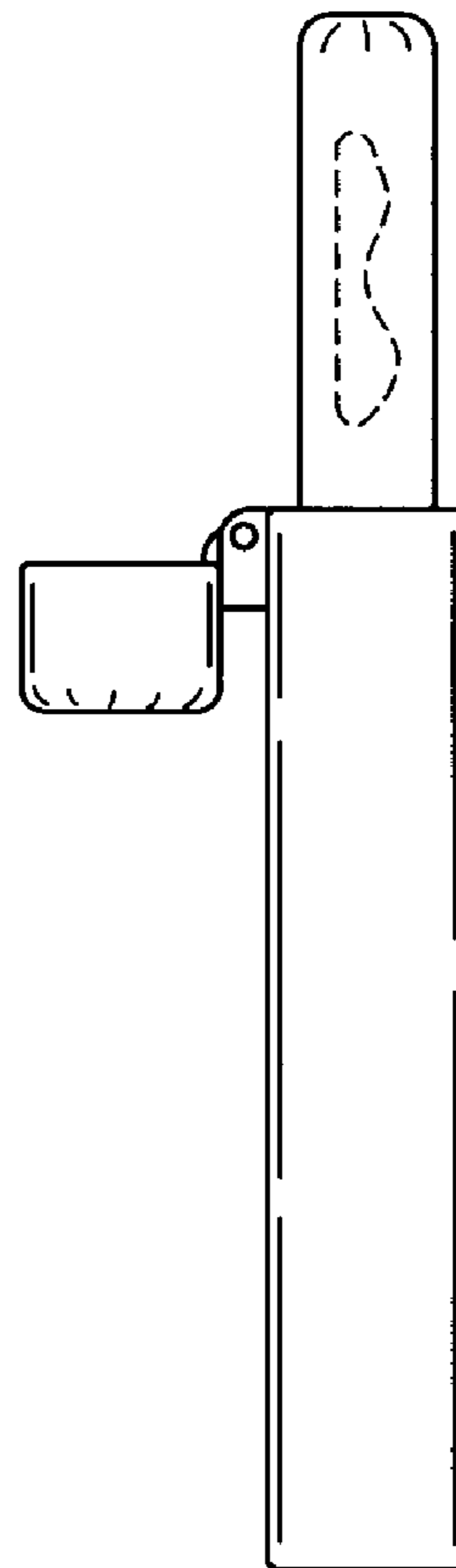

Fig. 14

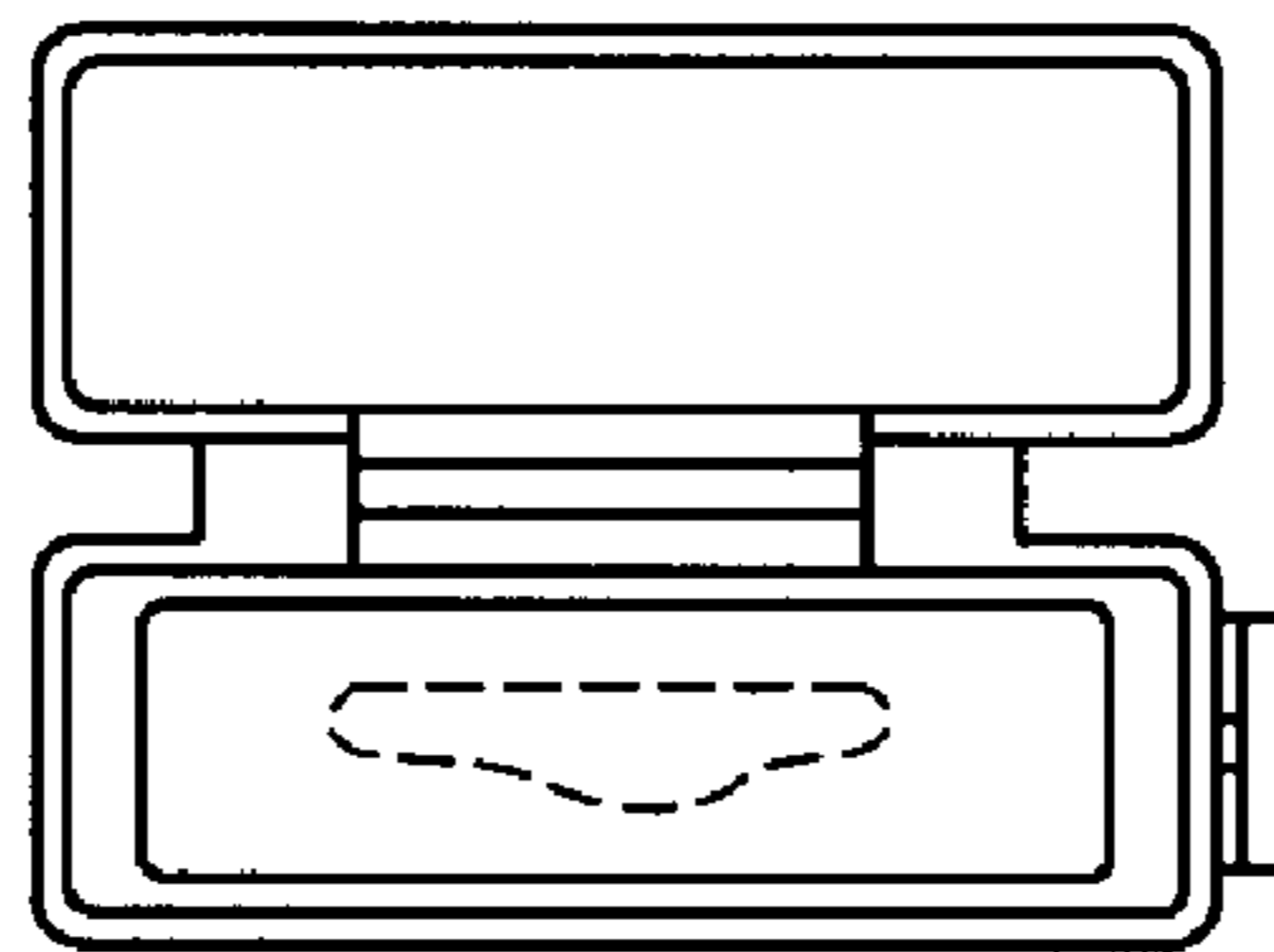

Fig. 15

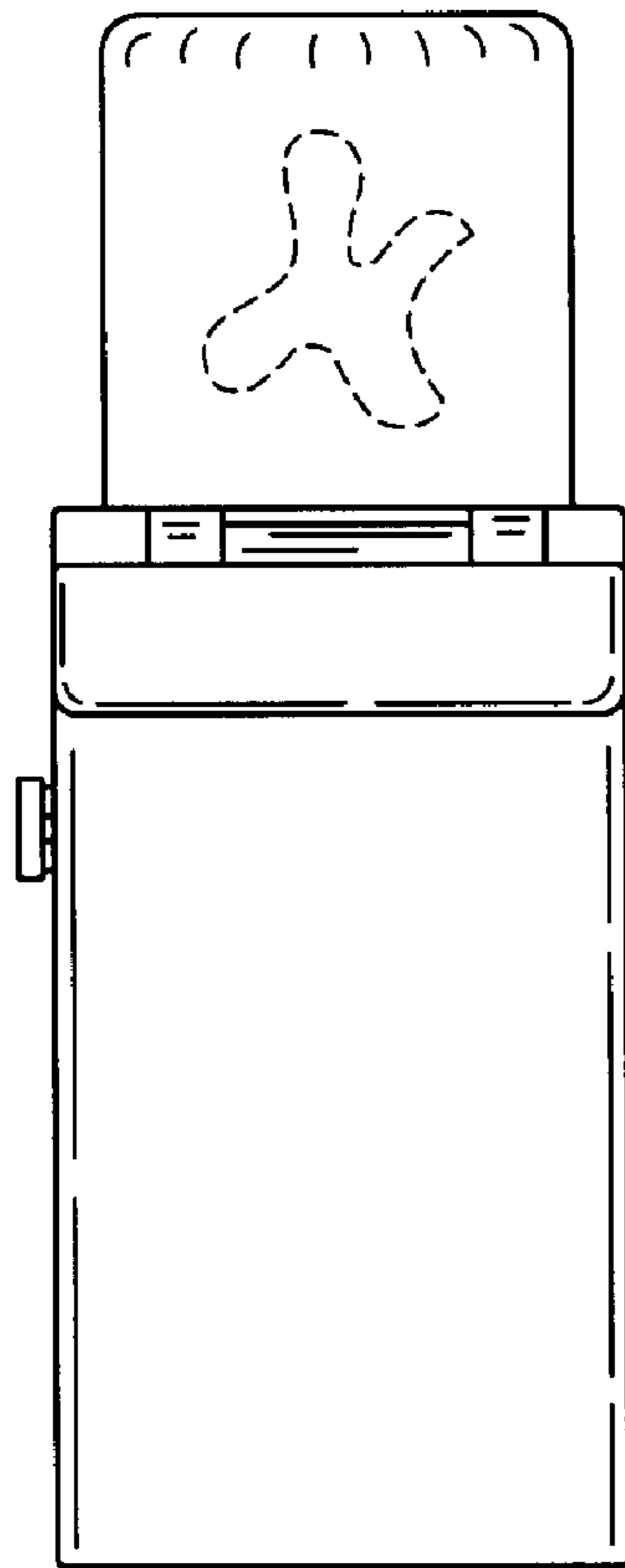

Fig. 16

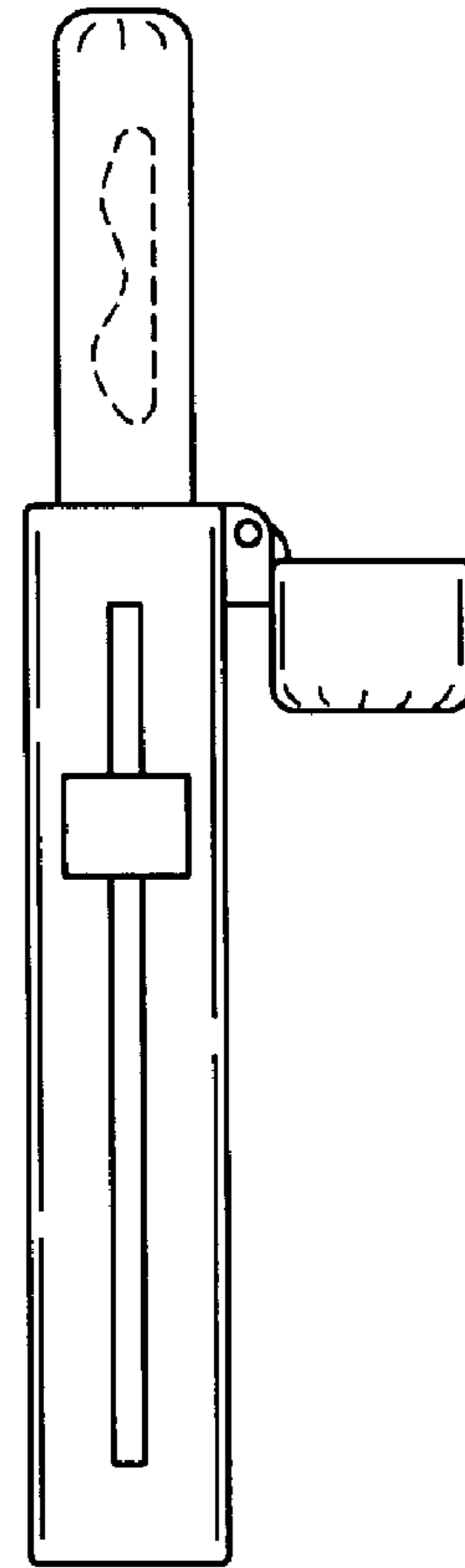

Fig. 17