



US00D526702S

(12) **United States Design Patent**  
**Kosasih**

(10) **Patent No.:** **US D526,702 S**

(45) **Date of Patent:** **\*\* Aug. 15, 2006**

(54) **FAUCET HANDLE**

(75) **Inventor:** **Angie L. Kosasih**, Rancho Santa Margarita, CA (US)

(73) **Assignee:** **Newfrey LLC**, Newark, DE (US)

(\*\*) **Term:** **14 Years**

(21) **Appl. No.:** **29/225,924**

(22) **Filed:** **Mar. 22, 2005**

(51) **LOC (8) Cl.** ..... **23-01**

(52) **U.S. Cl.** ..... **D23/252**

(58) **Field of Classification Search** ..... D23/238–257;  
D8/250–257, 300–322, DIG. 3; 16/110.1;  
4/675–678; 137/801

See application file for complete search history.

(56) **References Cited**

**U.S. PATENT DOCUMENTS**

D285,106 S	8/1986	Yost	
D325,772 S	* 4/1992	Carr	D23/252
D453,347 S	2/2002	Kaneko et al.	
D458,347 S	* 6/2002	Mullenmeister	D23/252
D460,158 S	* 7/2002	Green et al.	D23/252
D464,405 S	* 10/2002	Lord	D23/252
D470,924 S	2/2003	Marshall	
D474,671 S	* 5/2003	Singtoroj et al.	D8/301
D475,767 S	* 6/2003	Yegyayan et al.	D23/252
D489,120 S	4/2004	Shieh	
D490,502 S	* 5/2004	Ouyoung	D23/252
D490,601 S	5/2004	Ouyoung	
D495,402 S	* 8/2004	Spiegelberg et al.	D23/252
D468,433 S	9/2004	Fritz	

D496,433 S	* 9/2004	Fritz	D23/252
D496,434 S	9/2004	Spangler	
D507,331 S	* 7/2005	Lord et al.	D23/252
D512,767 S	* 12/2005	Ouyoung	D23/252
D515,182 S	* 2/2006	Ouyoung	D23/252
D517,174 S	* 3/2006	Singtoroj	D23/252

\* cited by examiner

*Primary Examiner*—Louis S. Zarfes

*Assistant Examiner*—Gregory Andoll

(74) *Attorney, Agent, or Firm*—Richmond J. Veltman; John D. DelPonti

(57) **CLAIM**

The ornamental design for a faucet handle, as shown and described.

**DESCRIPTION**

FIG. 1 is a perspective view of the new design for a faucet handle;

FIG. 2 is a front view of the new design for a faucet handle, the back view being the mirror image;

FIG. 3 is a right side view of the new design for a faucet handle;

FIG. 4 is the left side view of the new design for a faucet handle.

FIG. 5 is a top view of the new design for a faucet handle; and,

FIG. 6 is a bottom view of the new design for a faucet handle.

The broken lines in the Figures are for illustrative purposes only and form no part of the claimed design.

**1 Claim, 3 Drawing Sheets**

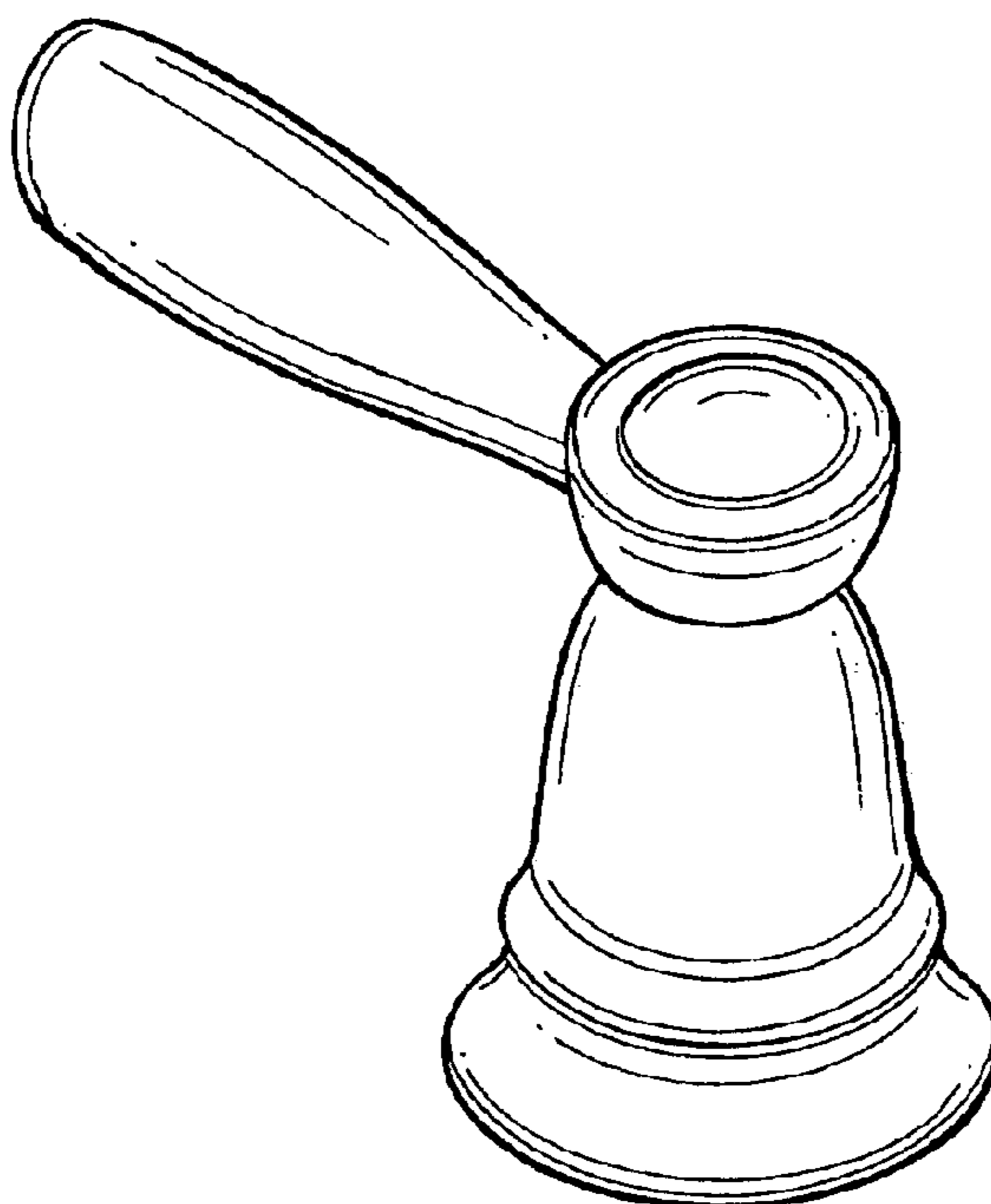

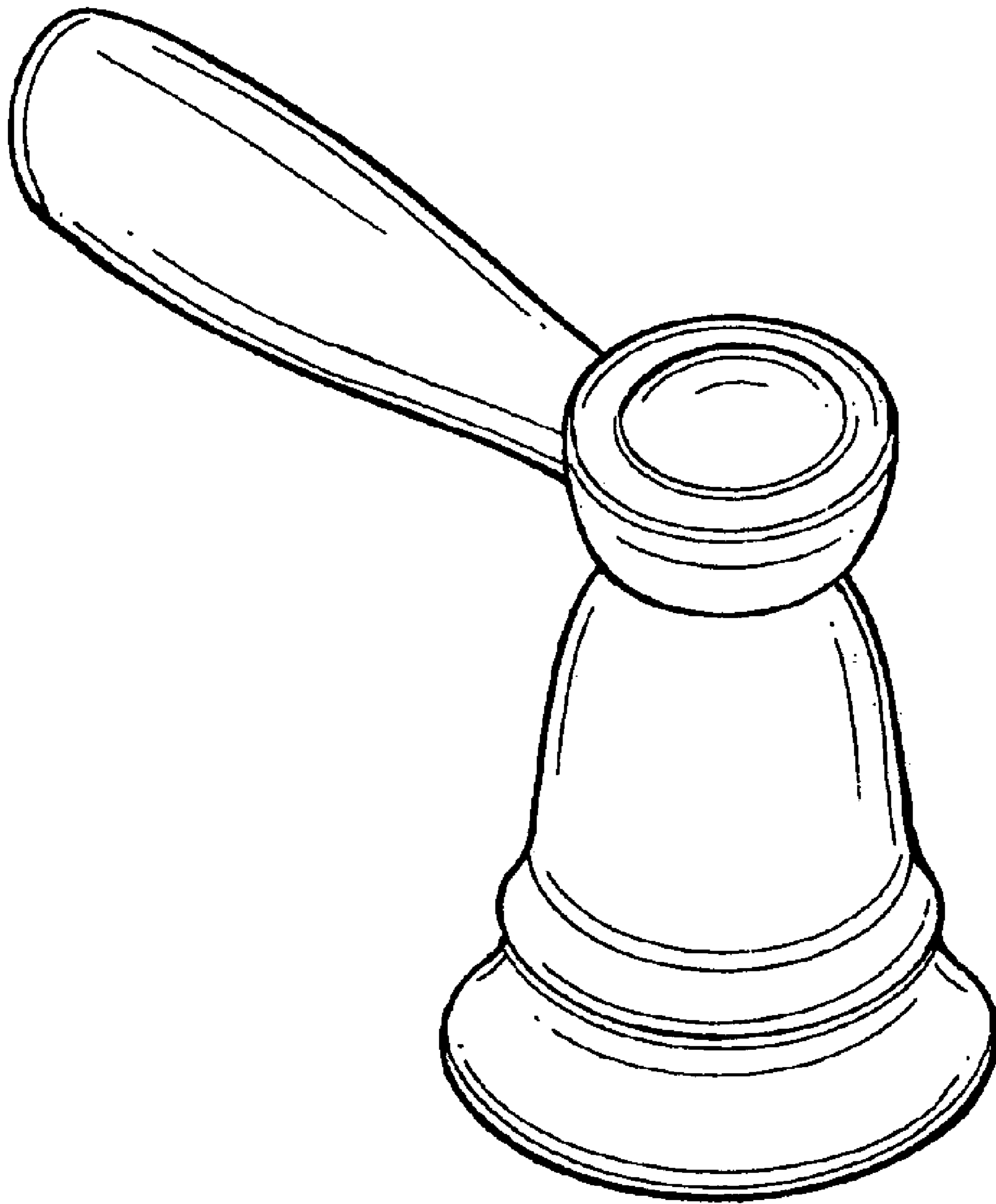
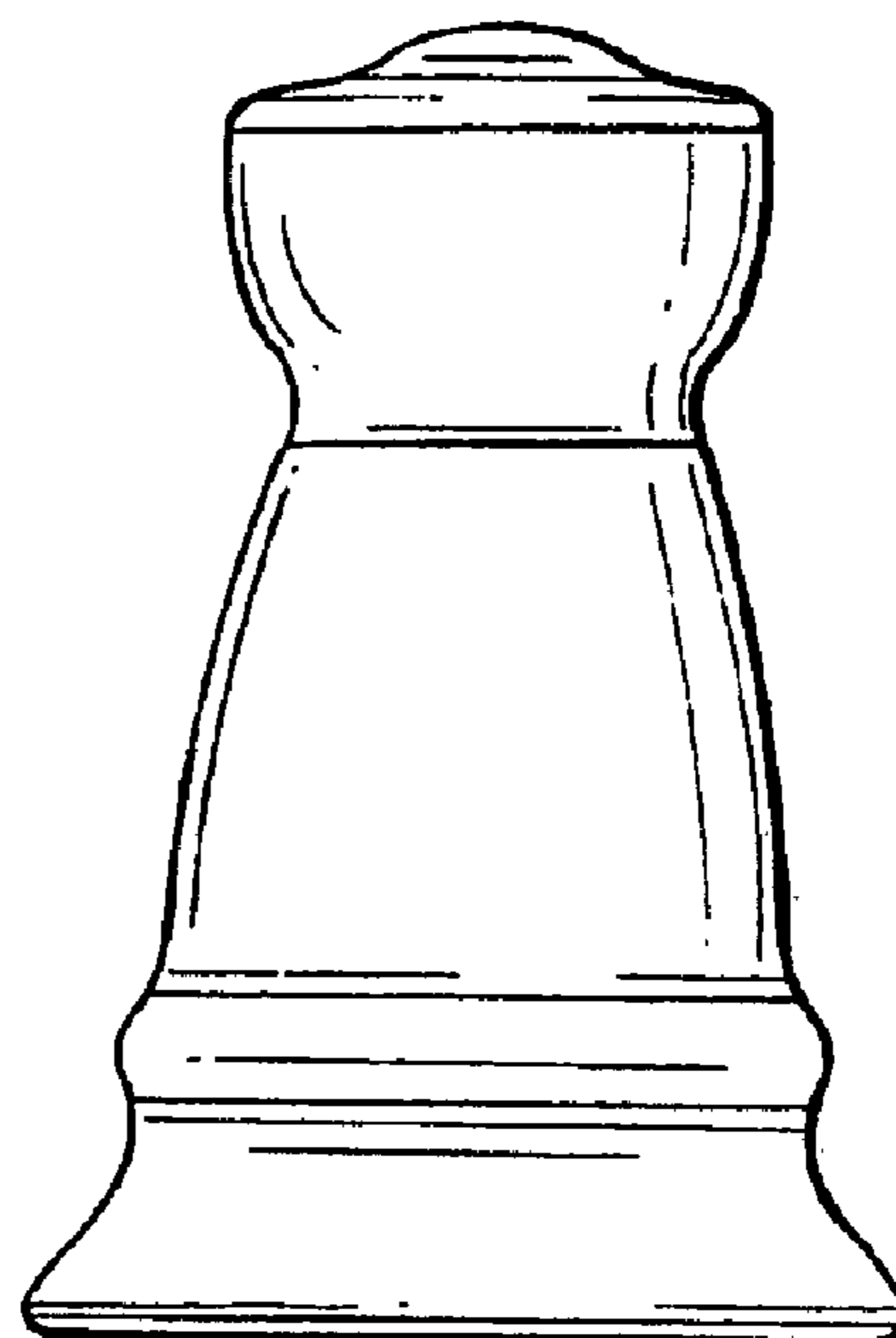
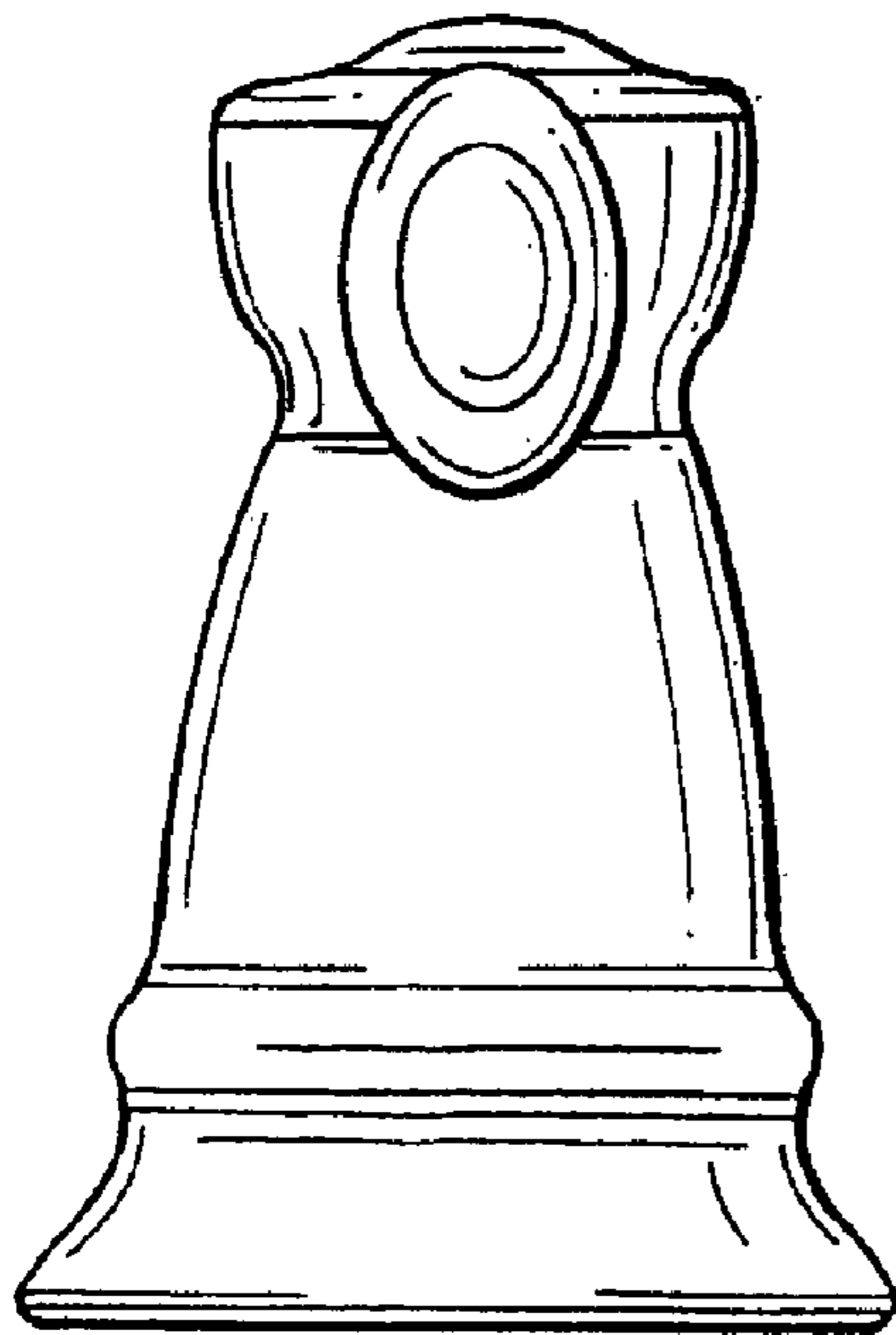
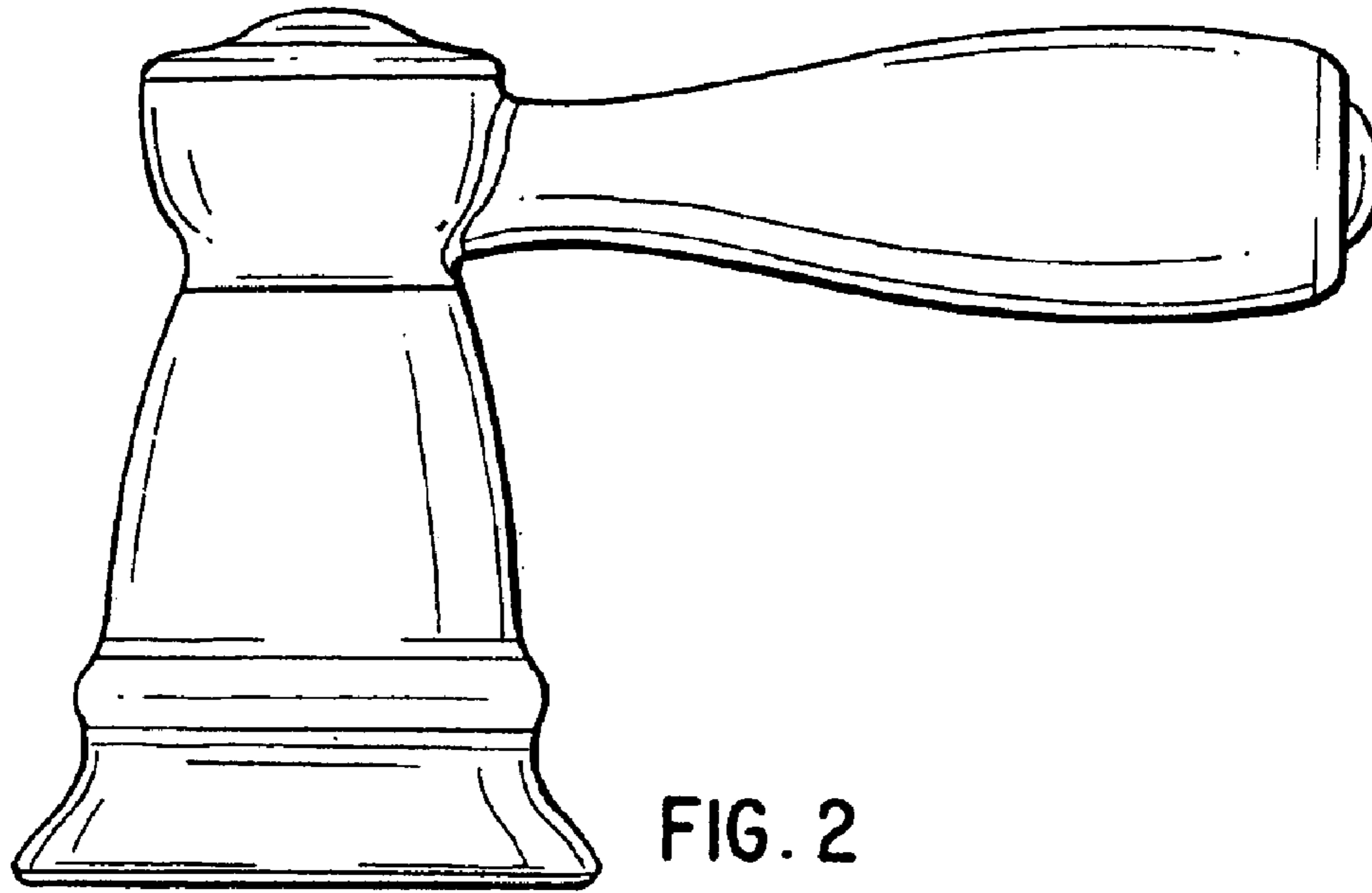

FIG. 1



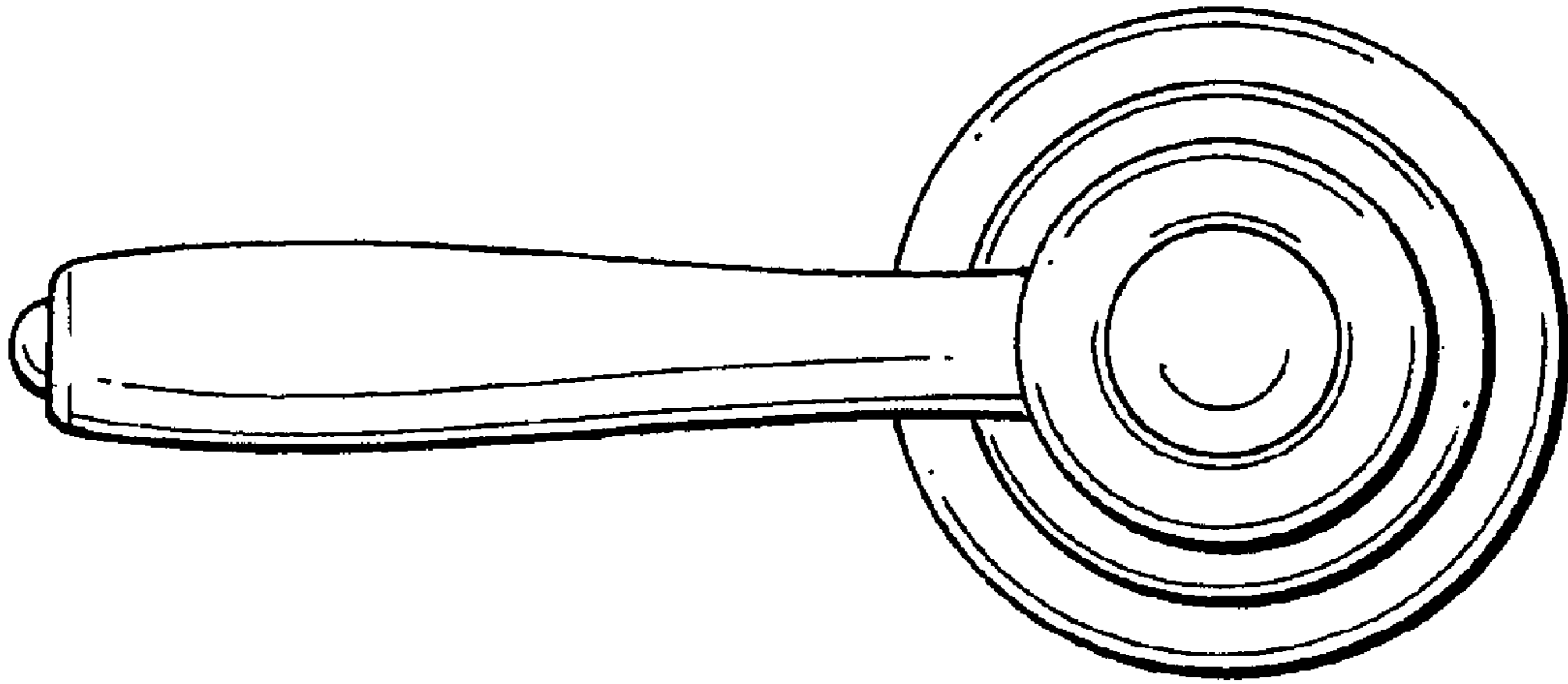

FIG. 5

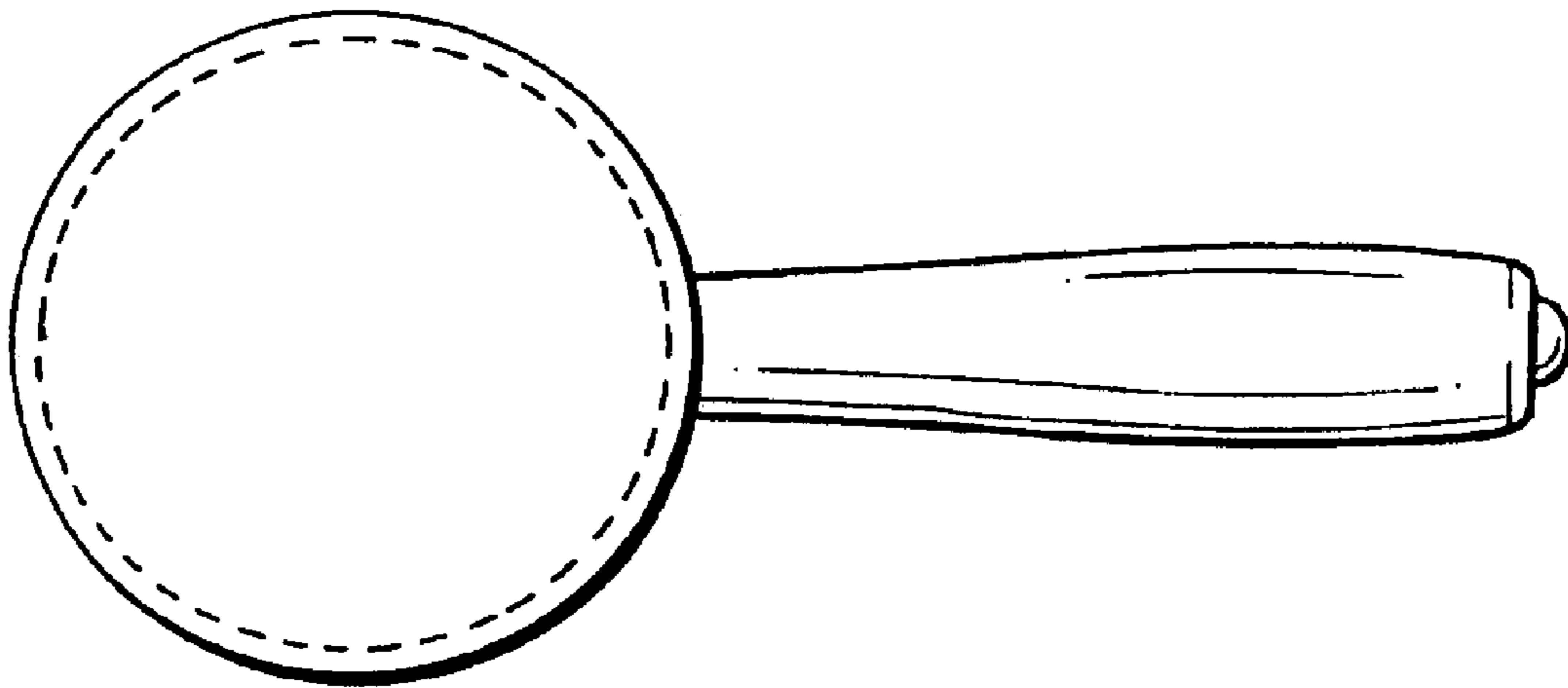

FIG. 6