

US00D526662S

(12) **United States Design Patent**
Choi

(10) **Patent No.:** **US D526,662 S**

(45) **Date of Patent:** **** Aug. 15, 2006**

(54) **DIGITAL AUDIO SYSTEM WITH A FILLET-SHAPED COVERING**

(75) Inventor: **Ka-Yuen Choi**, Yuen Long (HK)

(73) Assignee: **Lite-On Technology Corp.**, Taipei (TW)

(**) Term: **14 Years**

(21) Appl. No.: **29/226,908**

(22) Filed: **Apr. 5, 2005**

(30) **Foreign Application Priority Data**

Jan. 18, 2005 (TW) 94300282

(51) **LOC (8) Cl.** **14-03**

(52) **U.S. Cl.** **D14/496; D14/217; D14/250**

(58) **Field of Classification Search** D14/188, D14/496, 137, 168, 192, 193, 217, 224, 265, D14/250; 455/344-351; 369/6-12

See application file for complete search history.

(56) **References Cited**

U.S. PATENT DOCUMENTS

3,824,472 A * 7/1974 Engel et al. 455/343.1

4,972,508 A * 11/1990 King 455/351

5,038,400 A * 8/1991 Baracat et al. 455/90.3

5,175,873 A * 12/1992 Goldenberg et al. 455/351

D411,201 S * 6/1999 Munoz D14/217

D444,459 S * 7/2001 Matt et al. D14/217

6,397,047 B1 * 5/2002 Villamar et al. 455/90.1

D464,642 S * 10/2002 Kanno D14/217

D469,438 S * 1/2003 Corrales D14/432

6,684,089 B1 * 1/2004 Lee 455/575.3

* cited by examiner

Primary Examiner—Prabhakar Deshmukh

(74) *Attorney, Agent, or Firm*—Winston Hsu

(57) **CLAIM**

The ornamental design for a digital audio system with a fillet-shaped covering, as shown and described.

DESCRIPTION

FIG. 1 is a front view of a digital audio system with a fillet-shaped covering showing my design;

FIG. 2 is a rear view thereof;

FIG. 3 is a left view thereof;

FIG. 4 is a right view thereof;

FIG. 5 is a top plan view thereof;

FIG. 6 is a bottom plan view thereof; and,

FIG. 7 is a perspective view thereof.

1 Claim, 7 Drawing Sheets

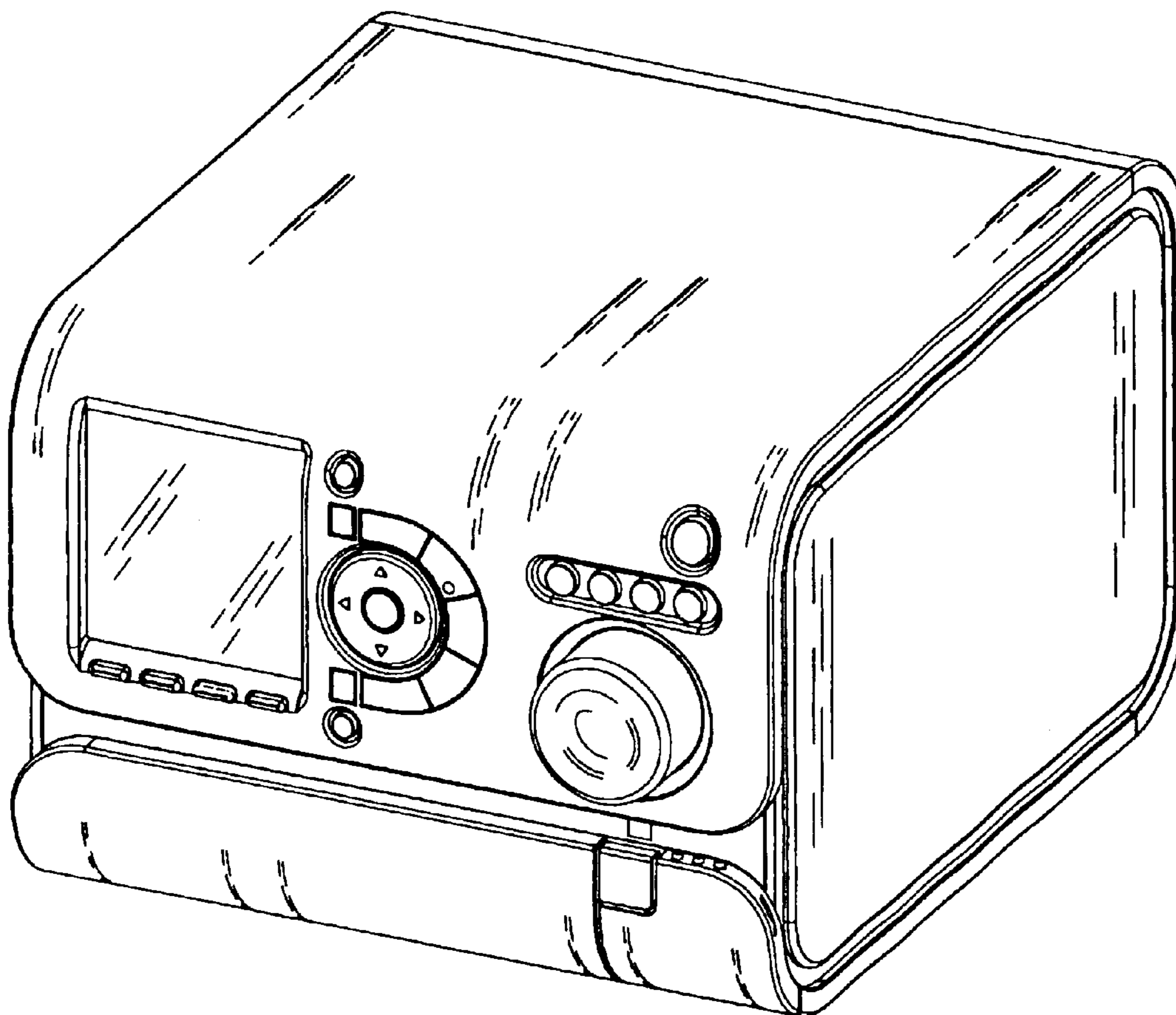

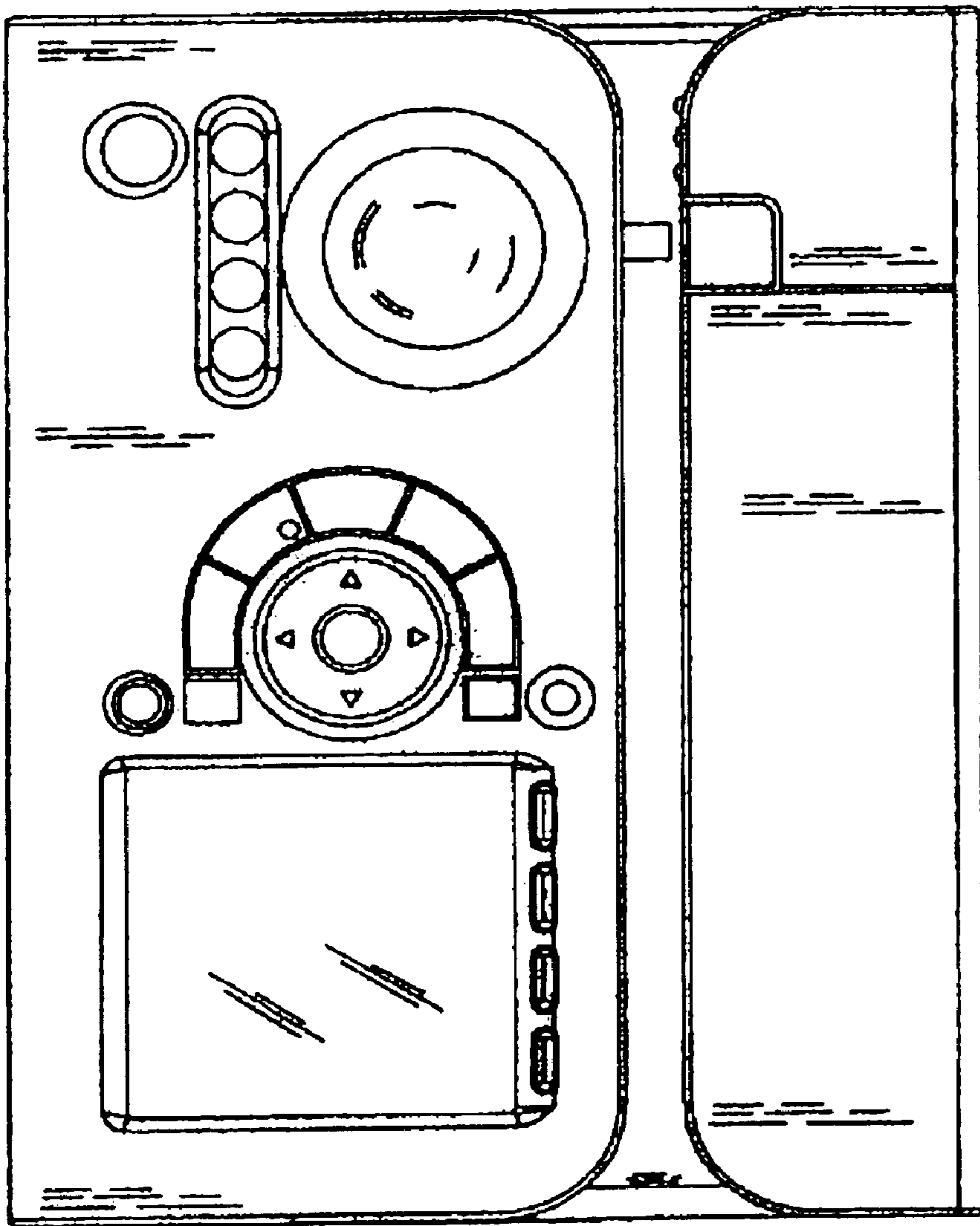

Fig. 1

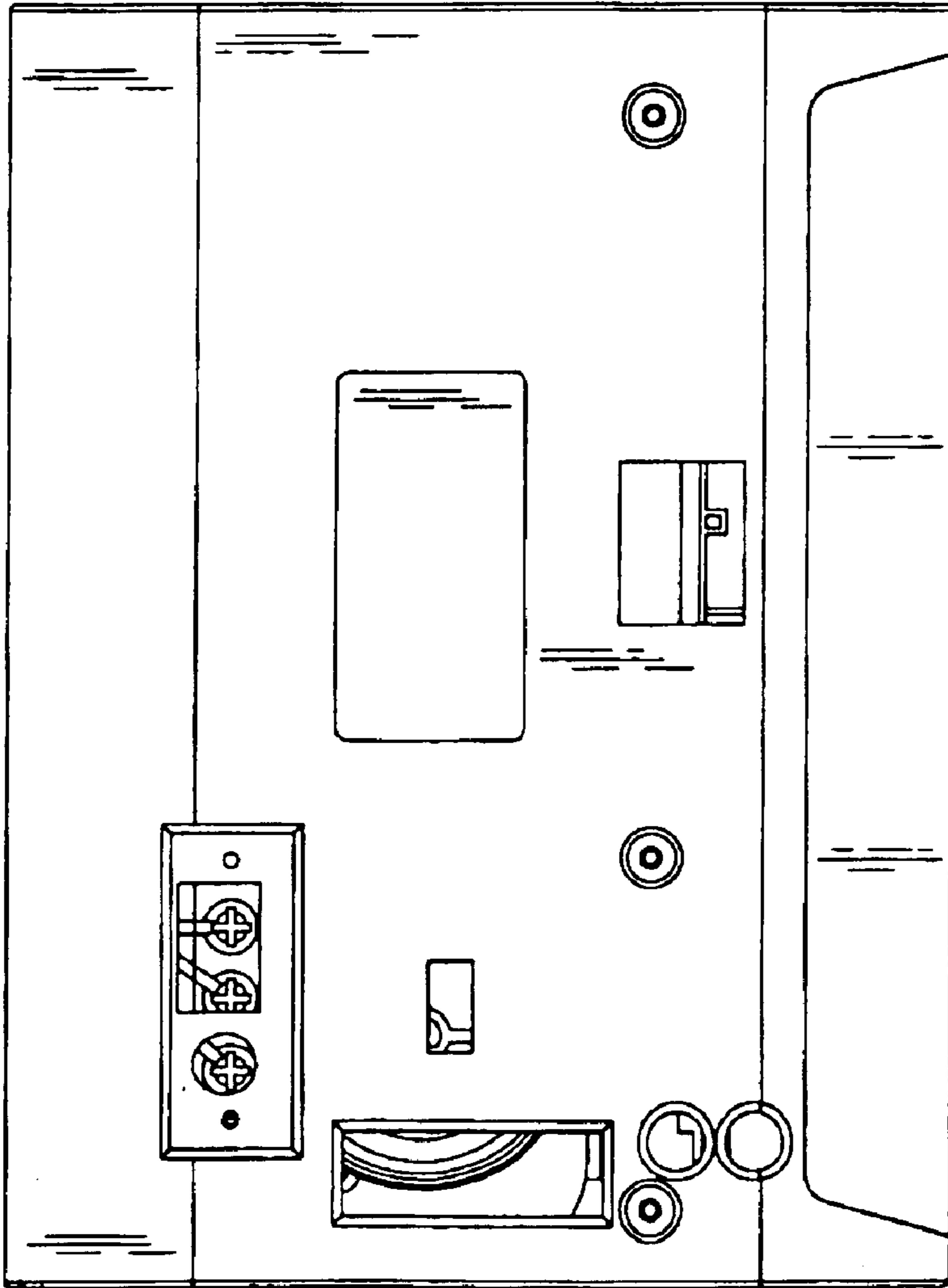

Fig. 2

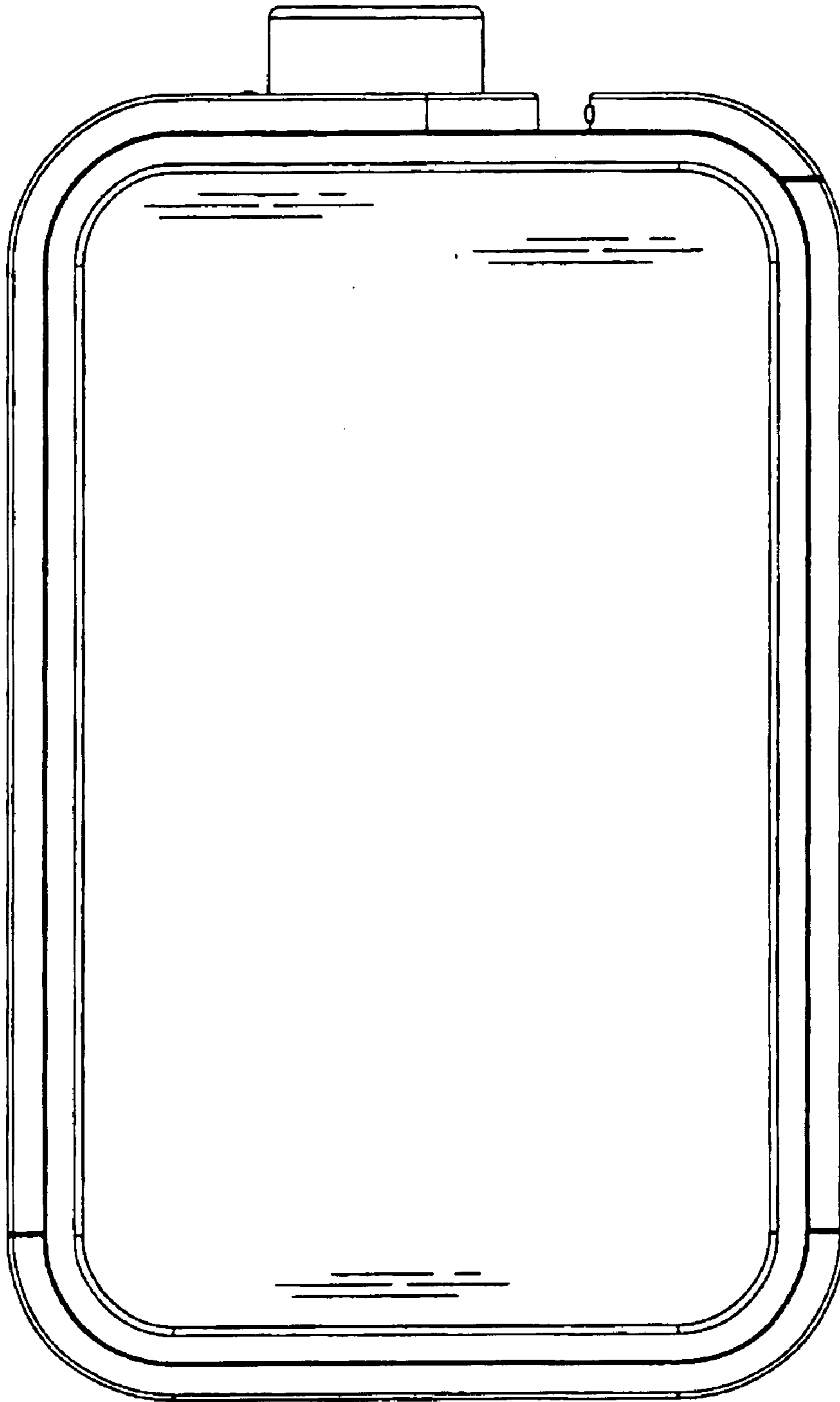

Fig. 3

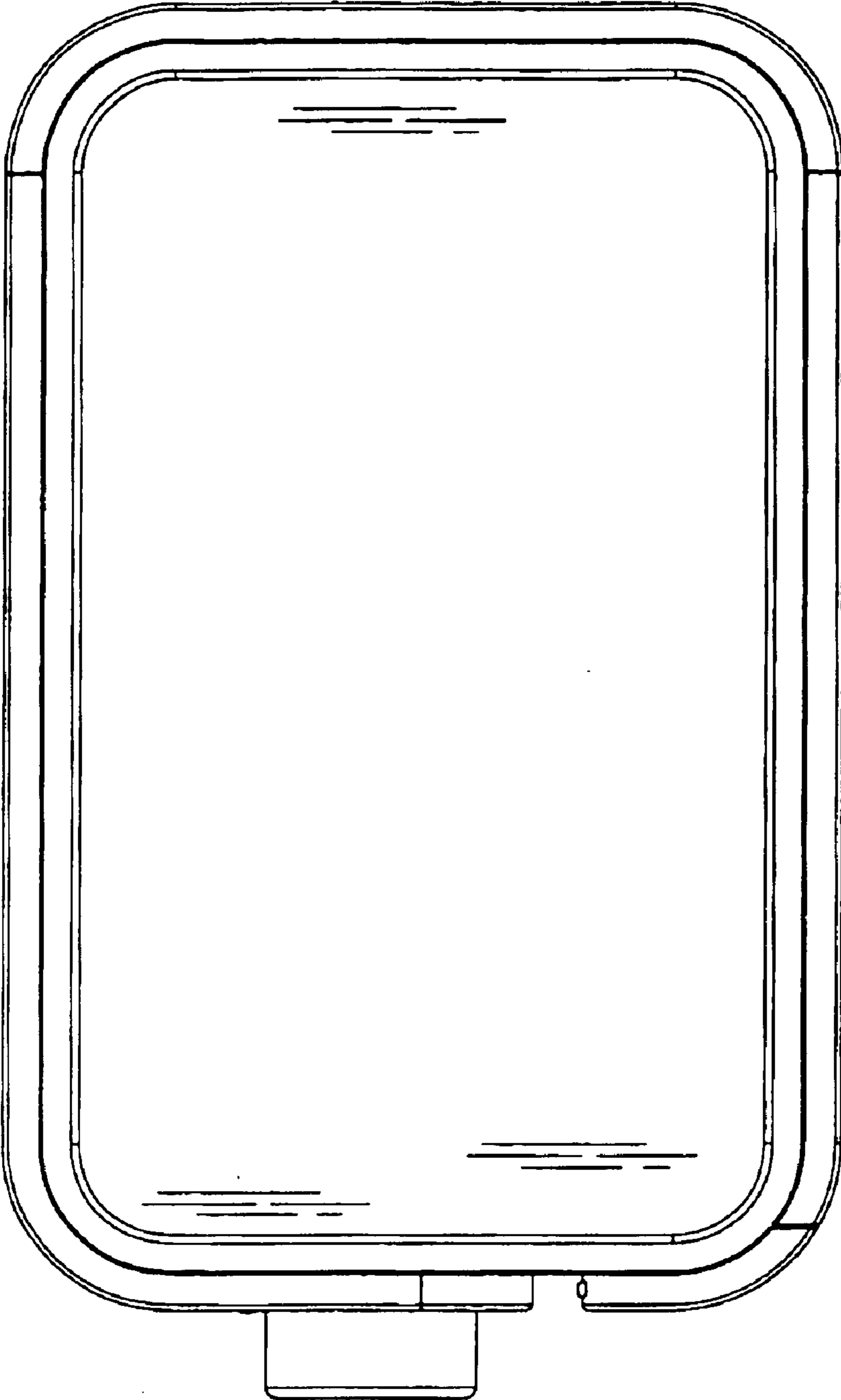

Fig. 4

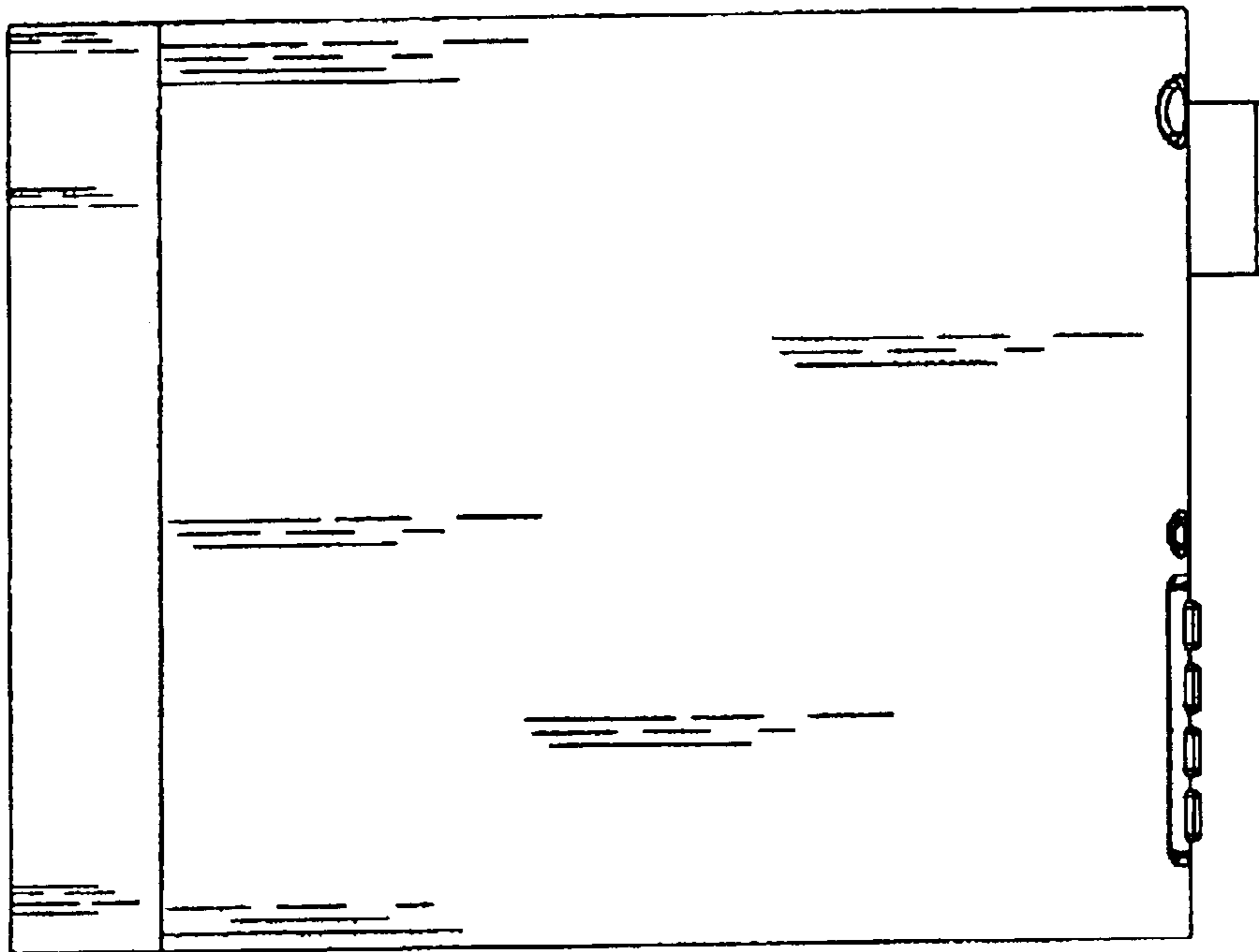

Fig. 5

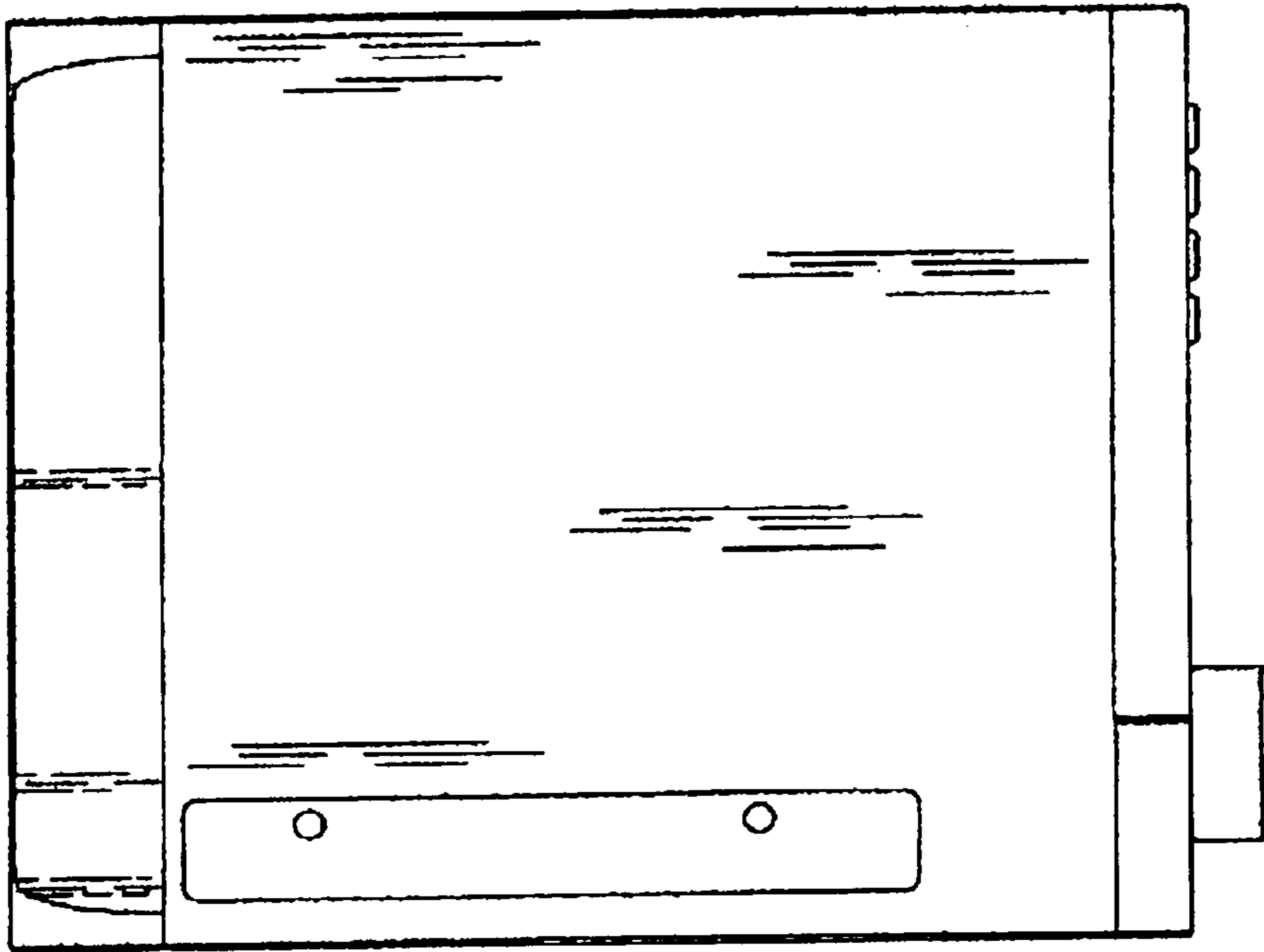

Fig. 6

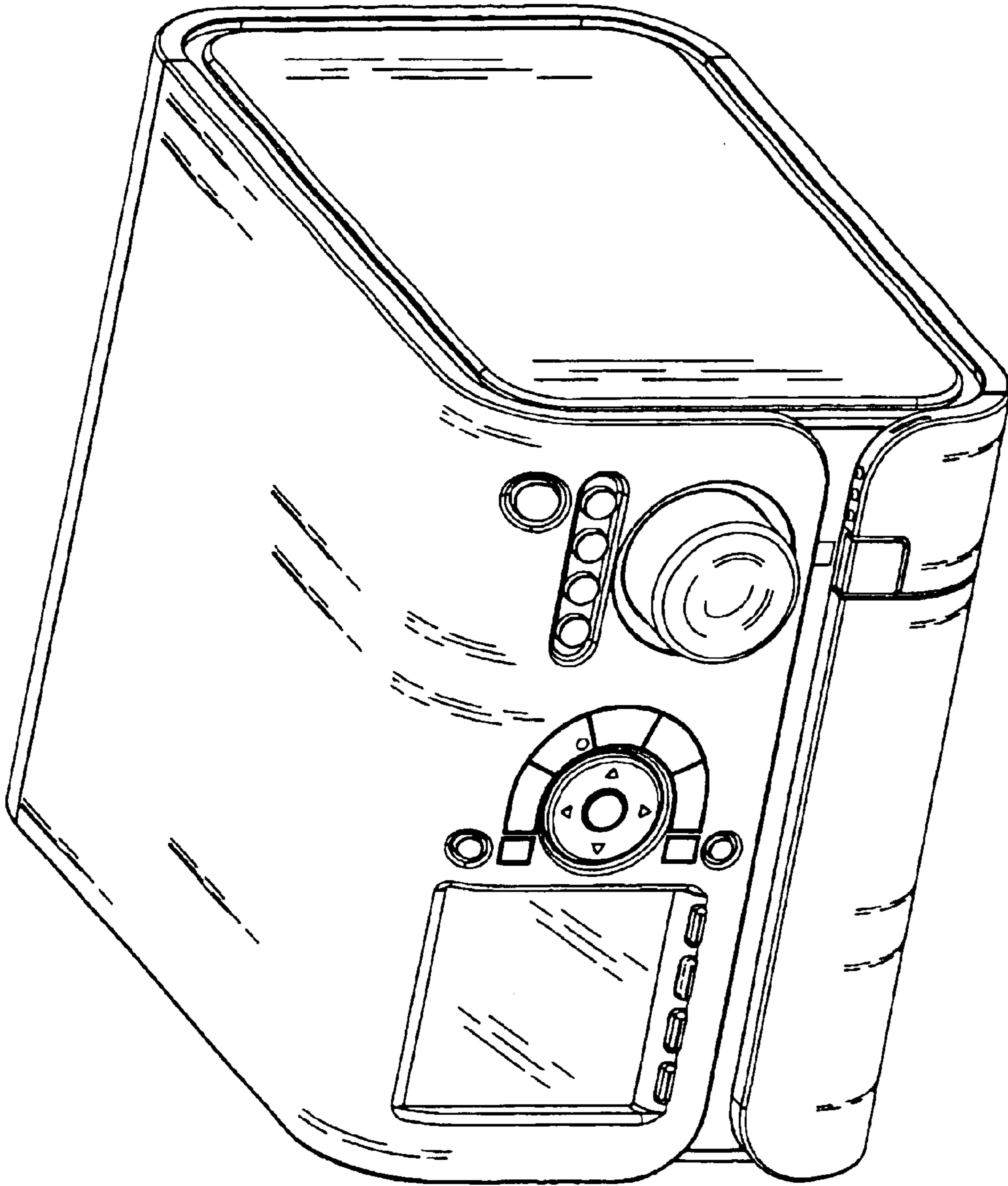

Fig. 7