



US00D526640S

(12) **United States Design Patent**
Chin et al.

(10) **Patent No.:** **US D526,640 S**

(45) **Date of Patent:** **** Aug. 15, 2006**

(54) **AMPLIFIER**

(75) Inventors: **Ming-Hwa Chin**, Taoyuan (TW);
Kuei-Jung Yang, Taoyuan (TW)

(73) Assignee: **Enlight Corporation**, Taoyuan (TW)

(**) Term: **14 Years**

(21) Appl. No.: **29/229,407**

(22) Filed: **May 6, 2005**

(51) **LOC (8) Cl.** **14-03**

(52) **U.S. Cl.** **D14/188; D14/265**

(58) **Field of Classification Search** D14/188,
D14/204, 192-198, 137, 155, 217, 221, 224,
D14/265, 257, 258; 455/344-351, 575.1;
369/6-12, 75.11; 360/137; D13/184, 199;
330/1 R, 3, 4, 250, 185, 207 R, 207 A
See application file for complete search history.

(56) **References Cited**

U.S. PATENT DOCUMENTS

3,091,736	A	*	5/1963	Germain	455/90.3
3,184,911	A	*	5/1965	Canale et al.	368/24
3,622,700	A	*	11/1971	Goetz, Jr.	348/839
3,708,618	A	*	1/1973	Hofmeister et al.	348/839
3,970,782	A	*	7/1976	Fenne	348/839

D327,682	S	*	7/1992	Shimazu	D14/168
D424,563	S	*	5/2000	Schmeichel et al.	D14/188
D478,564	S	*	8/2003	Rizzi	D14/188
D489,356	S	*	5/2004	Cho	D14/188
D495,012	S	*	8/2004	Morimoto	D14/188
D498,225	S	*	11/2004	Takeuchi et al.	D14/188
D500,490	S	*	1/2005	Zeitman	D14/188

* cited by examiner

Primary Examiner—Prabhakar Deshmukh

(74) *Attorney, Agent, or Firm*—Alan D. Kamrath; Nikolai & Mersereau, P.A.

(57) **CLAIM**

The ornamental design for an amplifier, as shown and described.

DESCRIPTION

FIG. 1 is a perspective view of a amplifier showing my new design;
FIG. 2 is a front view thereof;
FIG. 3 is a rear view thereof;
FIG. 4 is a left view thereof;
FIG. 5 is a right view thereof;
FIG. 6 is a top view thereof; and,
FIG. 7 is a bottom view thereof.

1 Claim, 7 Drawing Sheets

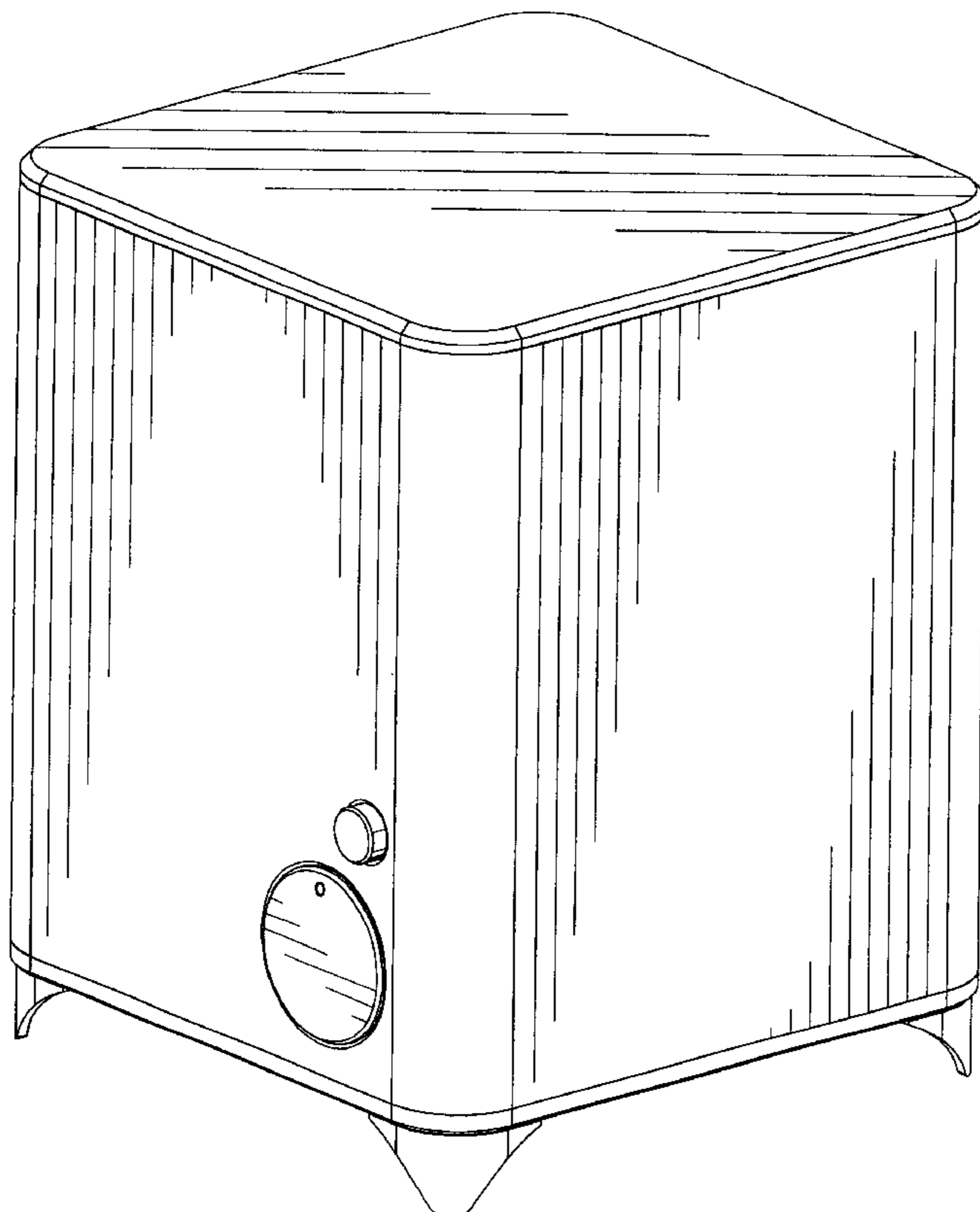

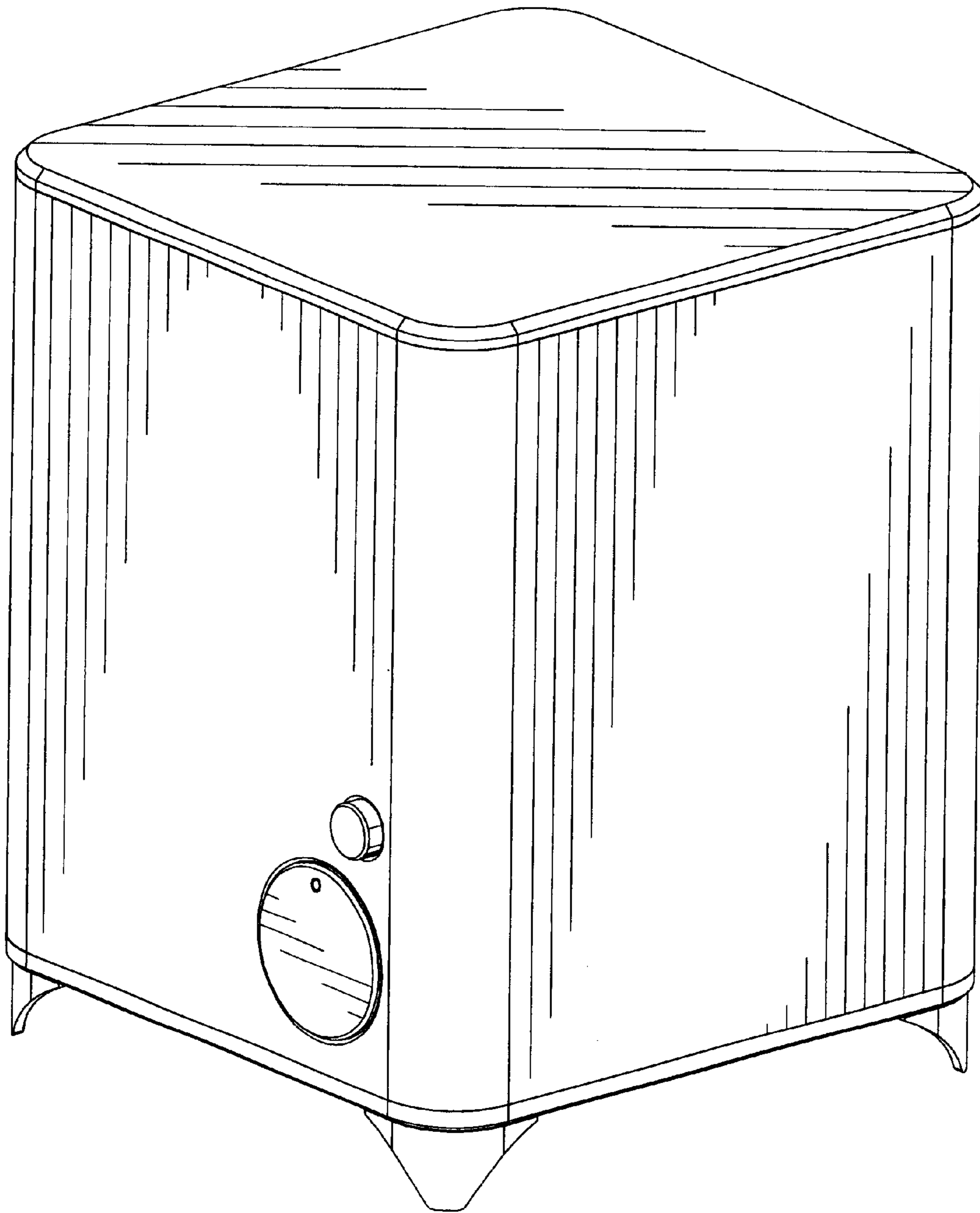

Fig. 1

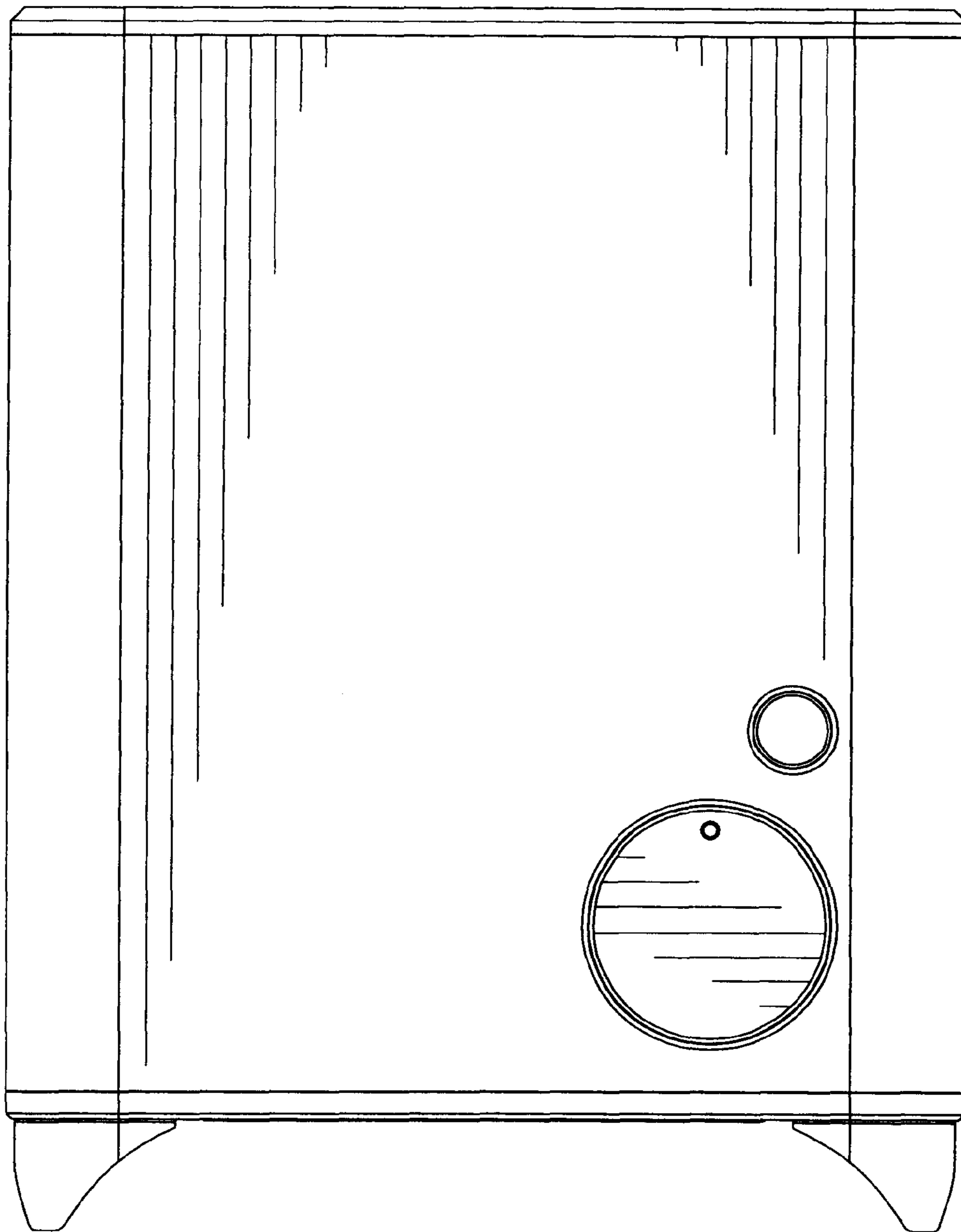

Fig. 2

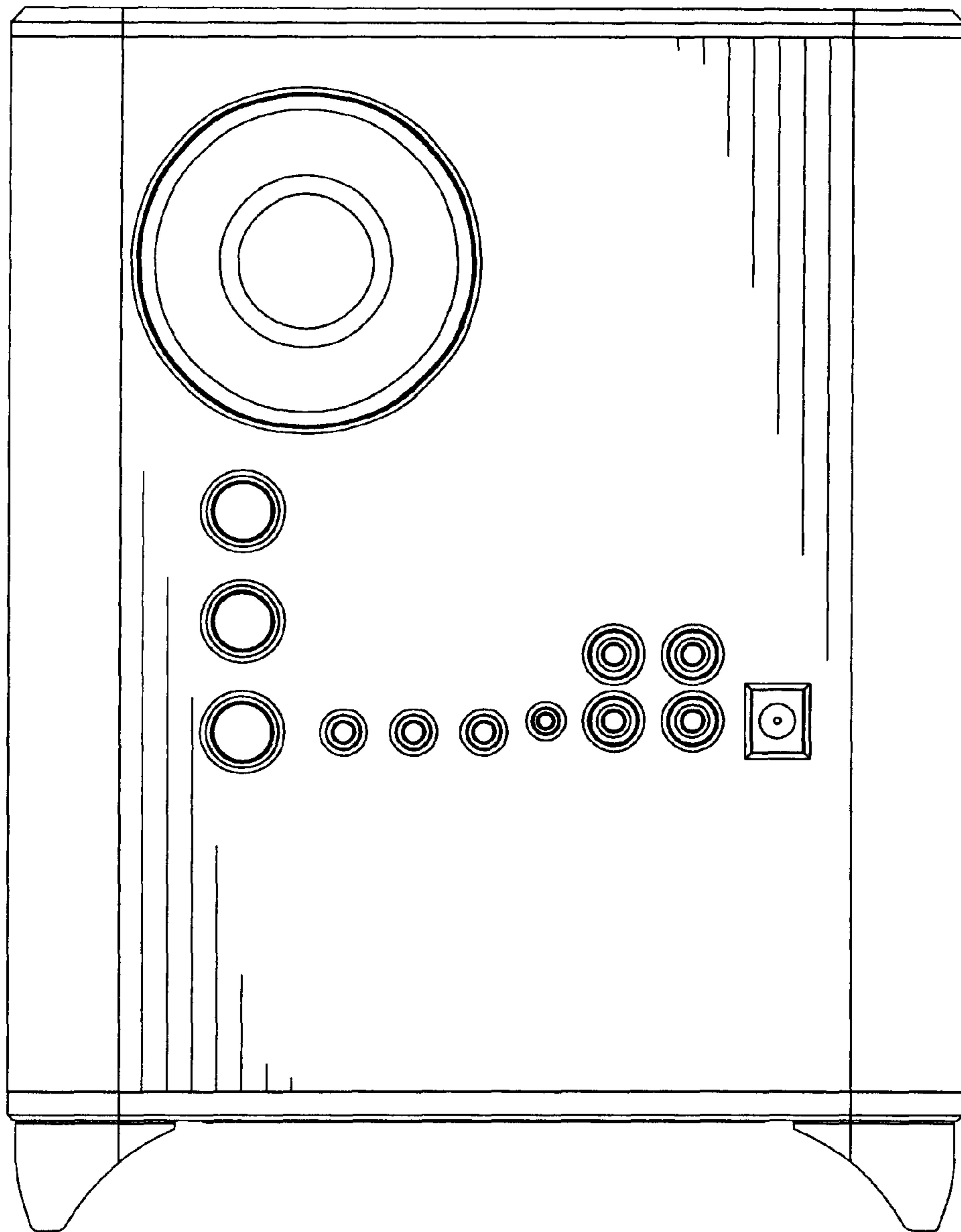

Fig. 3

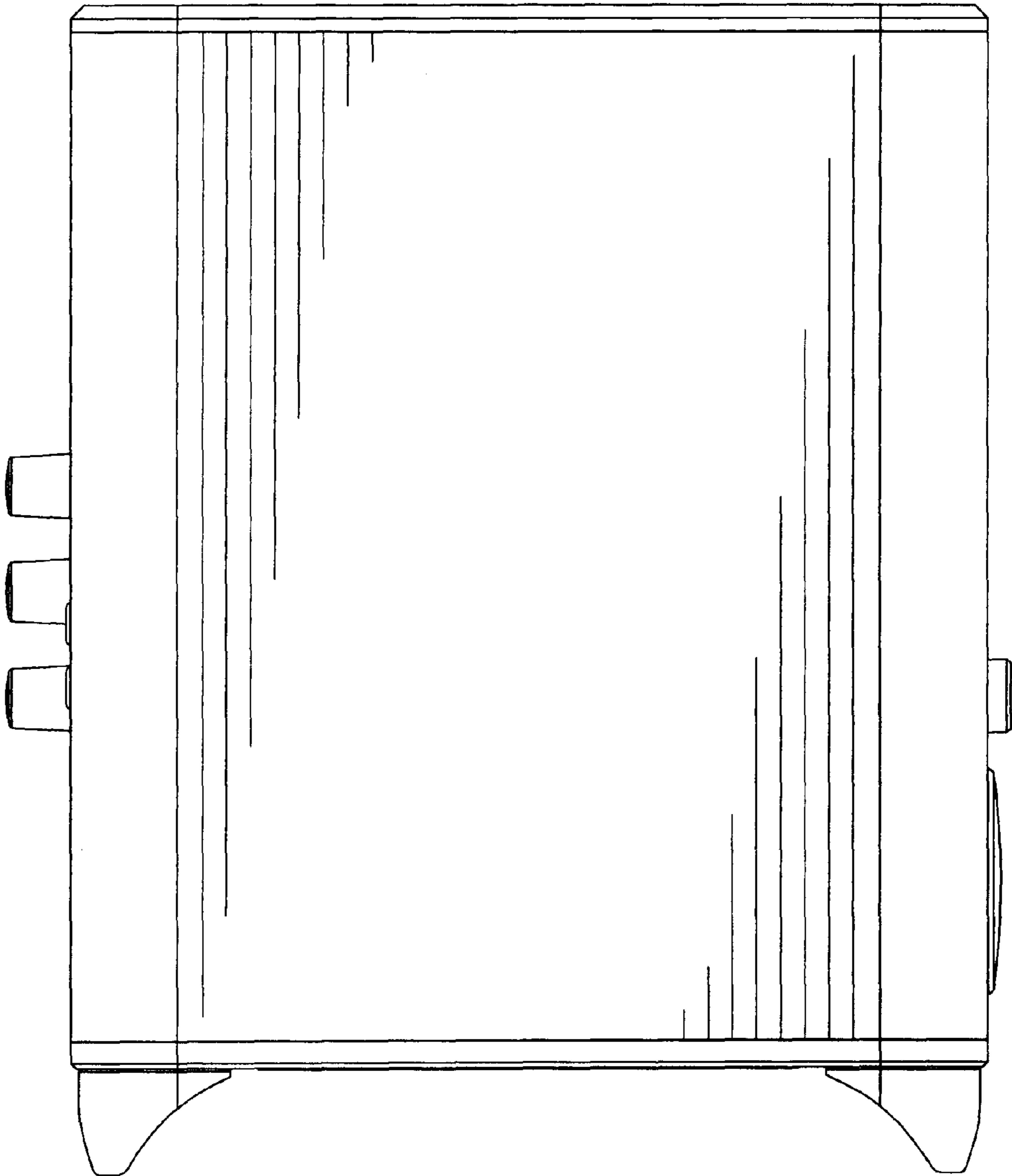

Fig. 4

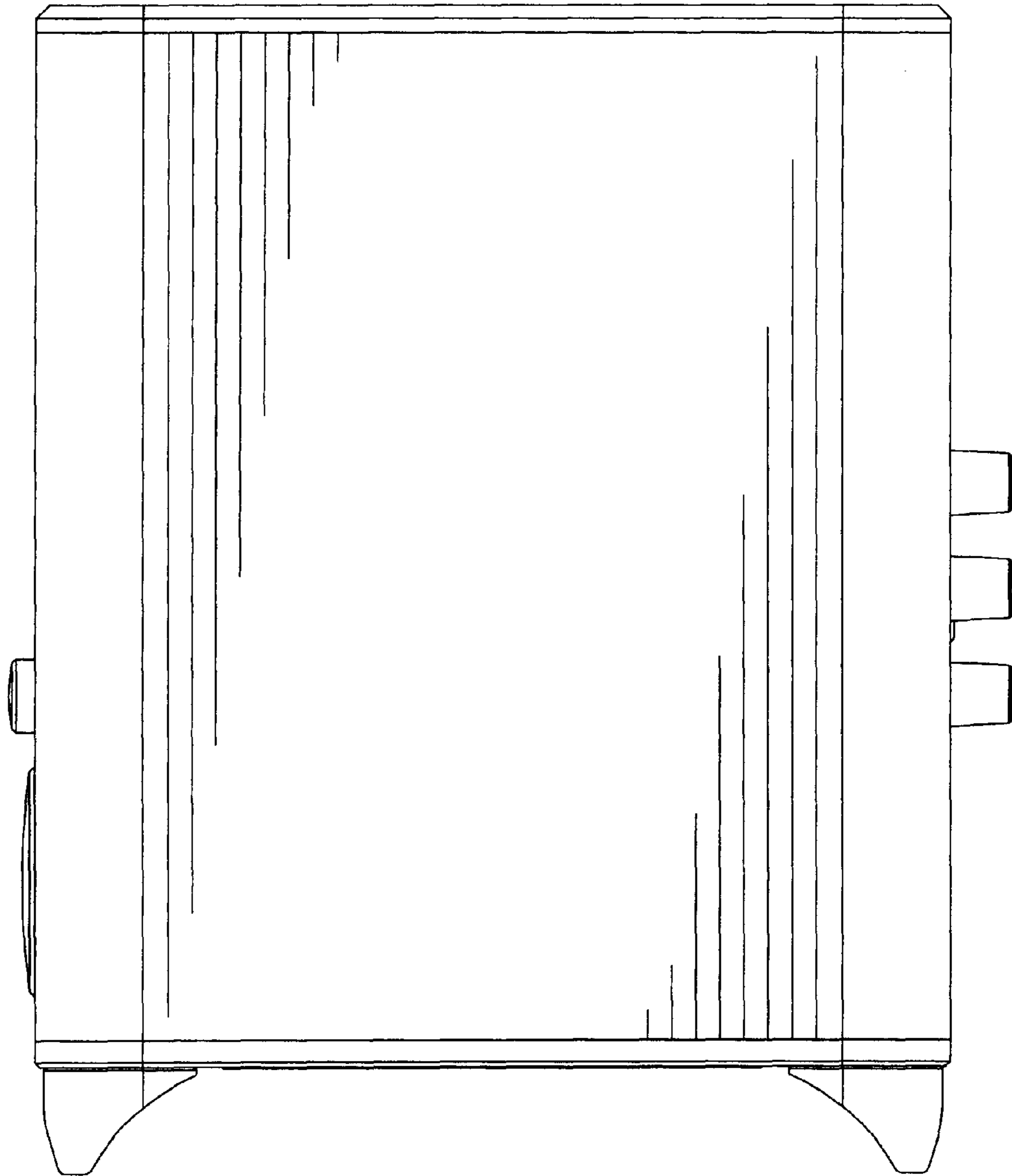

Fig. 5

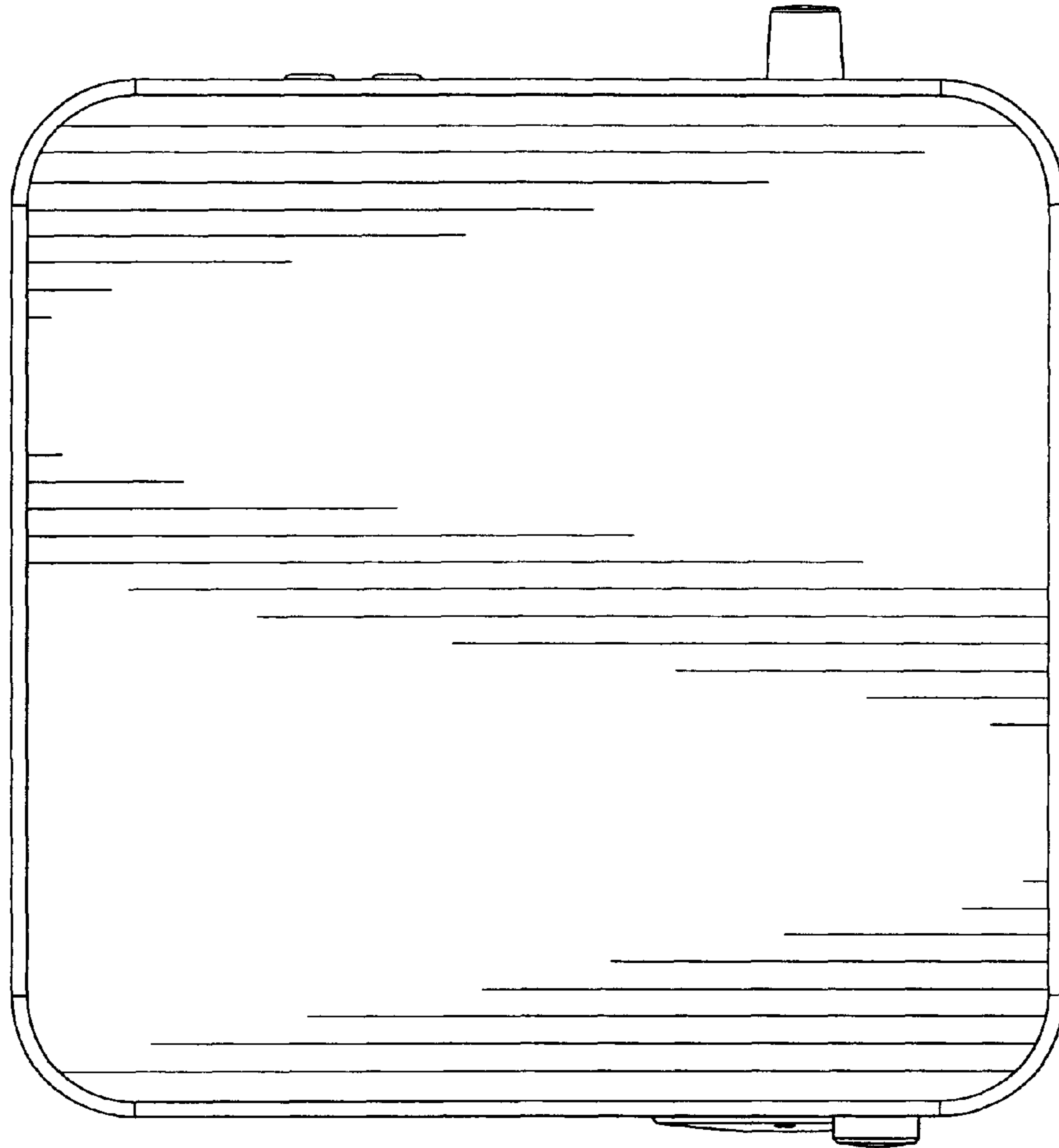

Fig. 6

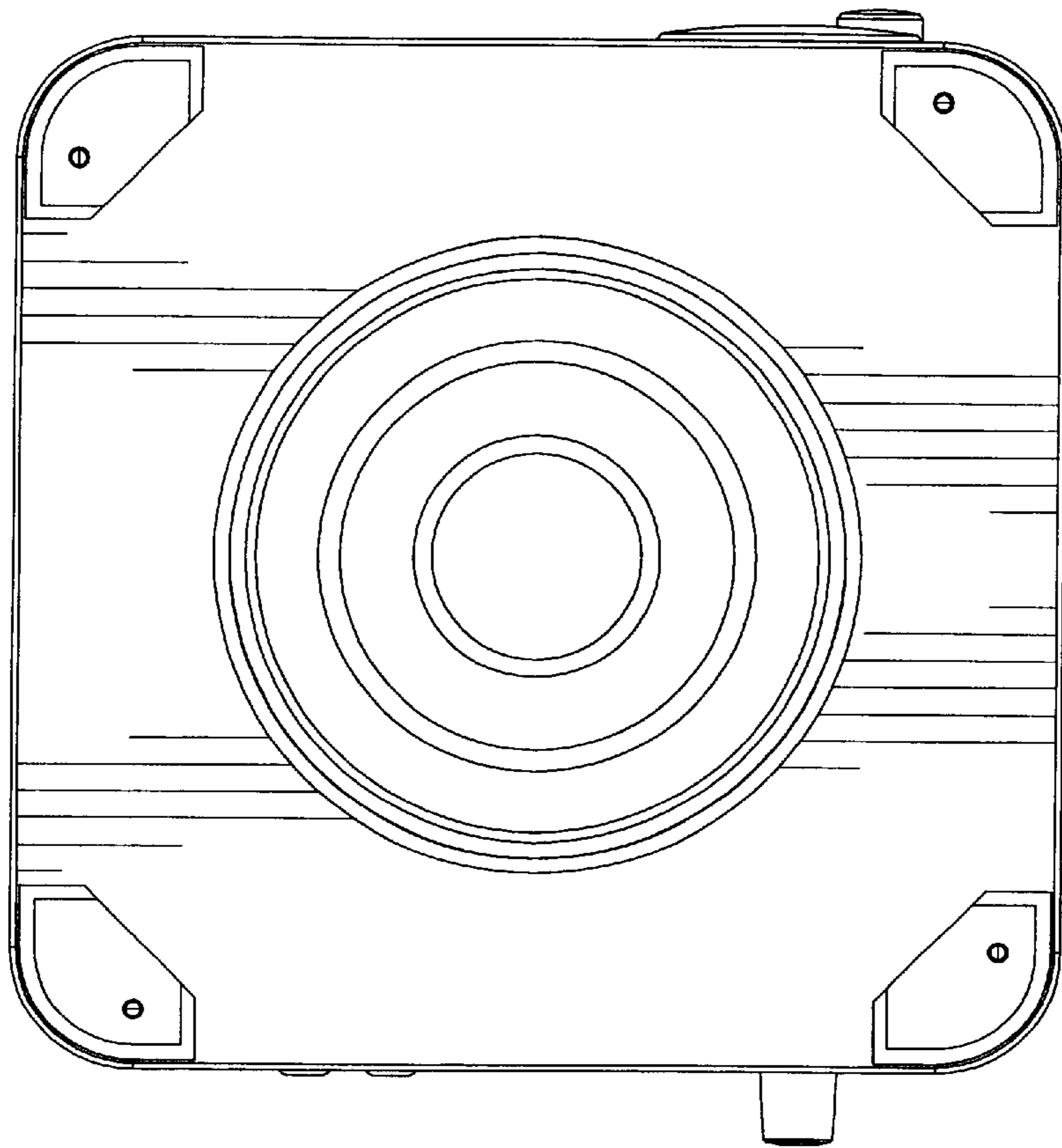

Fig. 7