



US00D526612S

(12) **United States Design Patent**
Sugeno et al.

(10) **Patent No.:** **US D526,612 S**

(45) **Date of Patent:** **** Aug. 15, 2006**

(54) **BATTERY**

(75) Inventors: **Kazuya Sugeno**, Fukushima (JP);
Hajime Ishihara, Tokyo (JP)

(73) Assignee: **Sony Computer Entertainment Inc.**,
Tokyo (JP)

(**) Term: **14 Years**

(21) Appl. No.: **29/224,852**

(22) Filed: **Mar. 9, 2005**

(30) **Foreign Application Priority Data**

Sep. 21, 2004 (JP) D2004-028465

(51) **LOC (8) Cl.** **13-02**

(52) **U.S. Cl.** **D13/103**

(58) **Field of Classification Search** D13/102-106,
D13/110, 118-119, 184; 428/96-100, 163,
428/176

See application file for complete search history.

(56) **References Cited**

U.S. PATENT DOCUMENTS

- 4,225,655 A * 9/1980 Pesce 429/100
- D264,580 S * 5/1982 McKeeman D13/103
- 4,391,883 A * 7/1983 Williamson et al. 429/97
- D409,974 S 5/1999 Sasago
- D457,132 S * 5/2002 Petherbridge et al. D13/103
- D467,538 S 12/2002 Kawasaki
- D481,995 S * 11/2003 Yokota D13/103
- D489,678 S * 5/2004 Axelrod D13/103

- D491,137 S 6/2004 Suzuki
- D492,649 S 7/2004 Resch et al.
- 6,824,916 B1 * 11/2004 Vine 429/96
- D503,923 S * 4/2005 Asherian D13/103
- 6,881,516 B1 * 4/2005 Aamodt et al. 429/181
- D507,523 S * 7/2005 Resch et al. D13/103
- D508,018 S * 8/2005 Yokota D13/103
- D510,721 S * 10/2005 Axelrod D13/103

FOREIGN PATENT DOCUMENTS

GB D-2076988 S 8/1999

* cited by examiner

Primary Examiner—Pamela Burgess

Assistant Examiner—Rosemary K. Tarcza

(74) *Attorney, Agent, or Firm*—Rader, Fishman & Garuer
PLLC

(57) **CLAIM**

The ornamental design for a battery, as shown.

DESCRIPTION

FIG. 1 is a front elevational view of a battery showing our new design;

FIG. 2 is a rear elevational view thereof;

FIG. 3 is a left side elevational view thereof;

FIG. 4 is a right side elevational view thereof;

FIG. 5 is a top plan view thereof;

FIG. 6 is a bottom plan view thereof;

FIG. 7 is a rear right top perspective view thereof; and,

FIG. 8 is a front right top perspective view thereof.

1 Claim, 5 Drawing Sheets

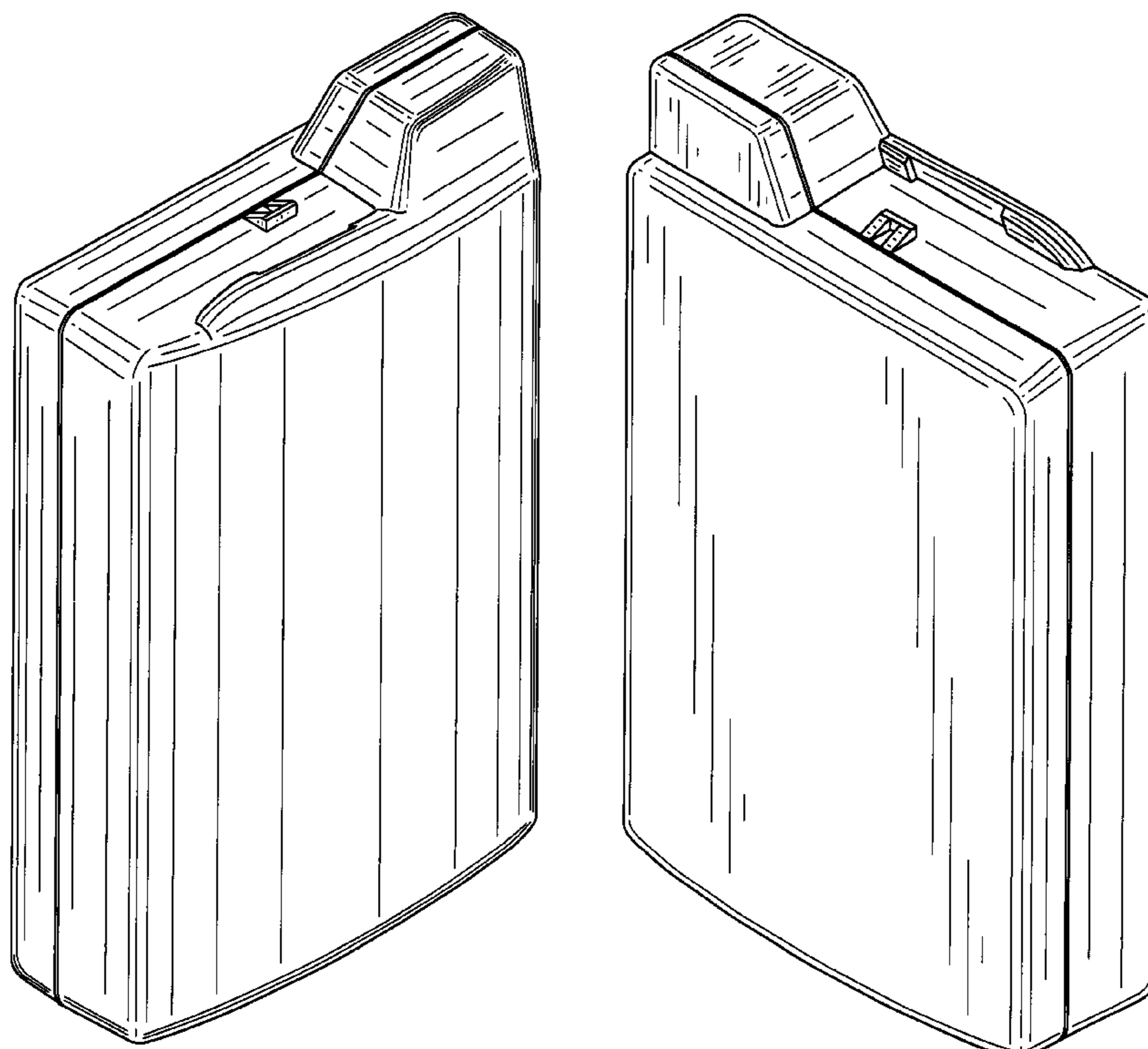

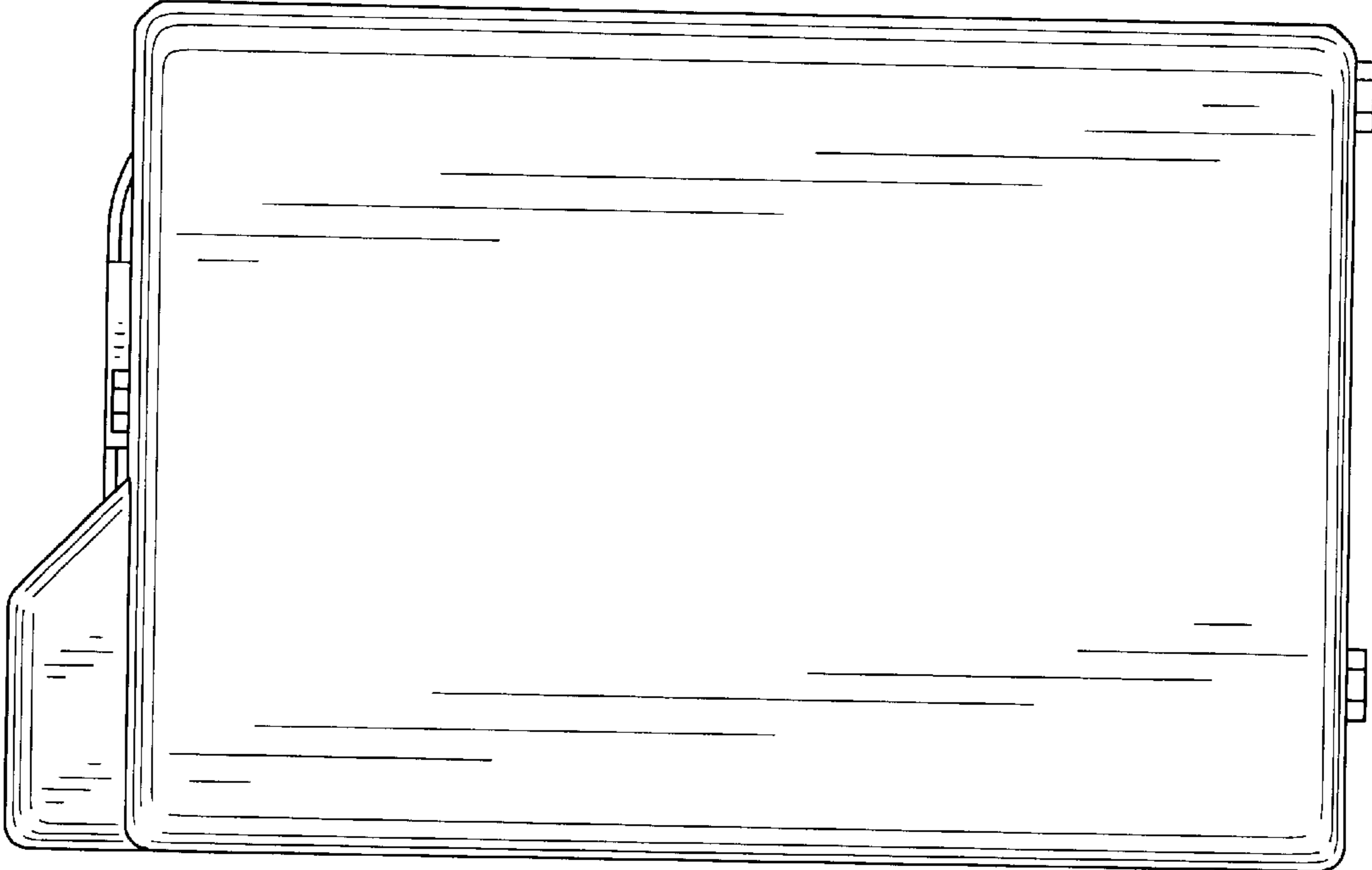

Fig. 2

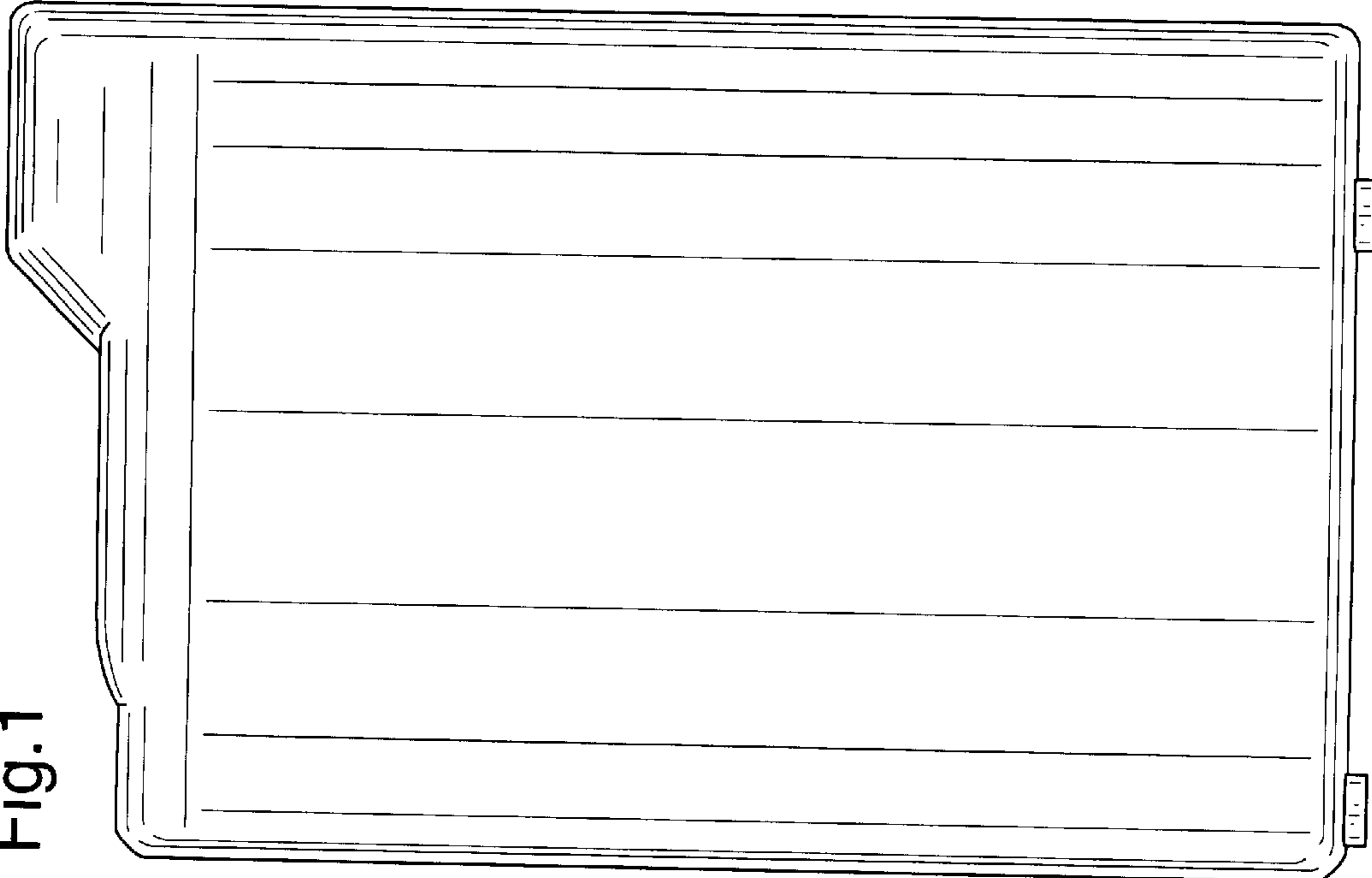

Fig. 1

Fig.3

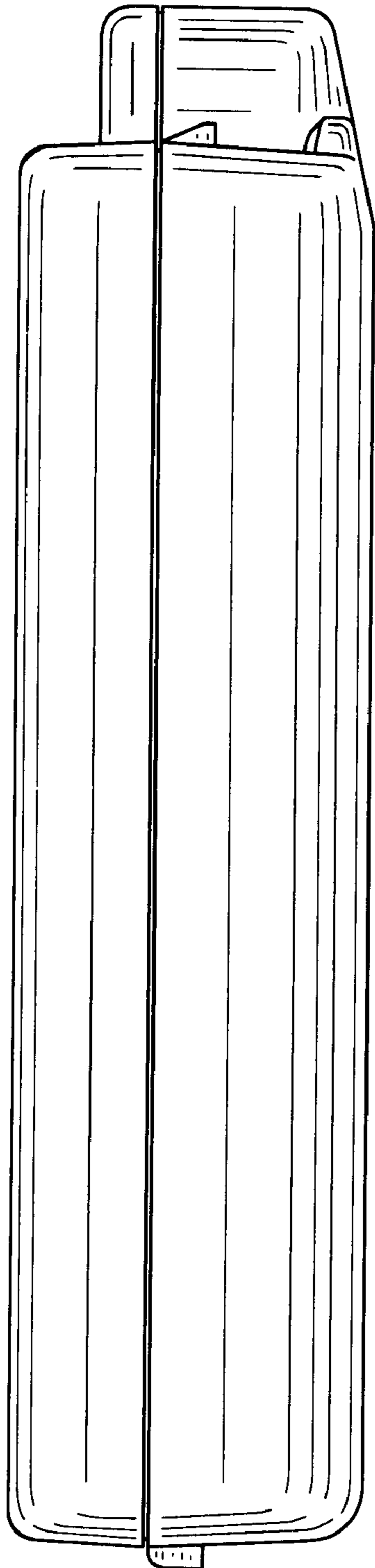

Fig.4

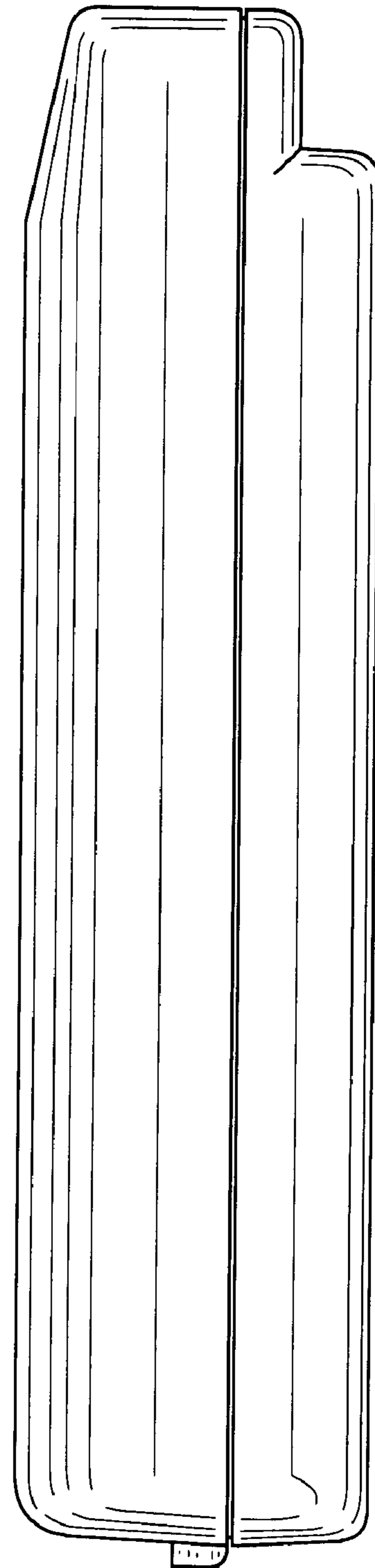

Fig.5

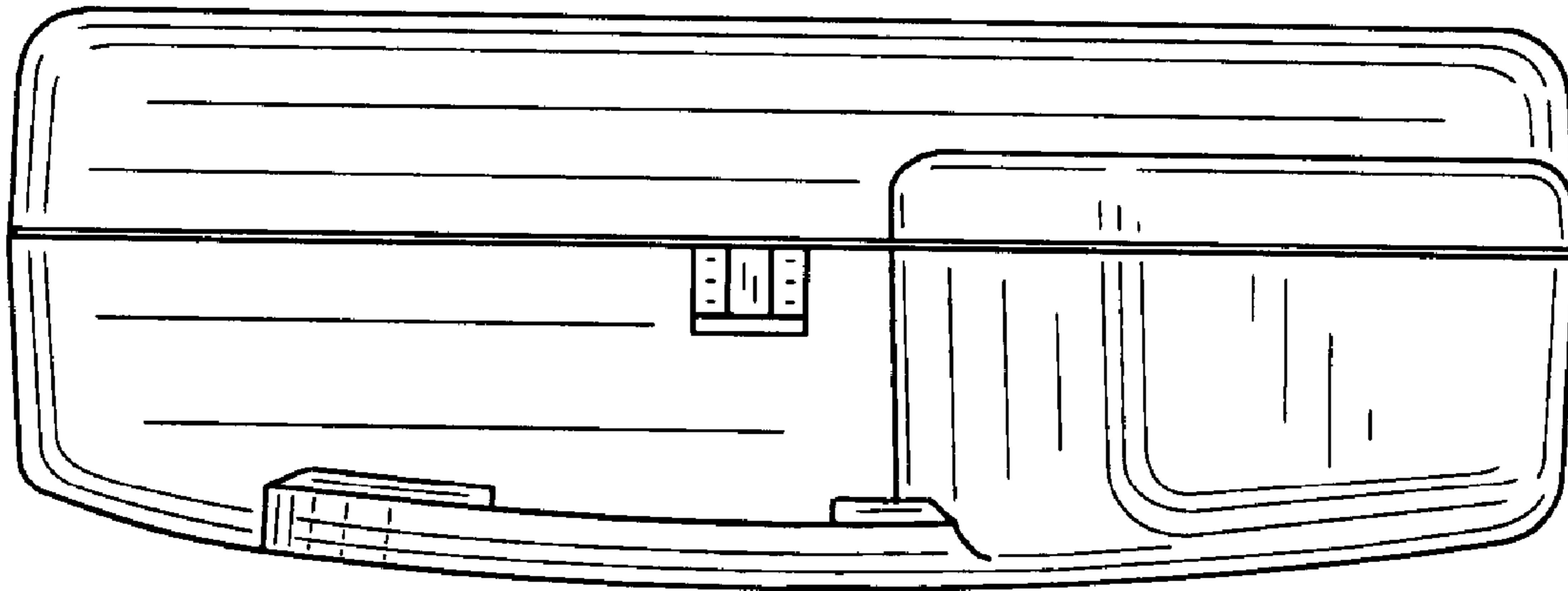

Fig.6

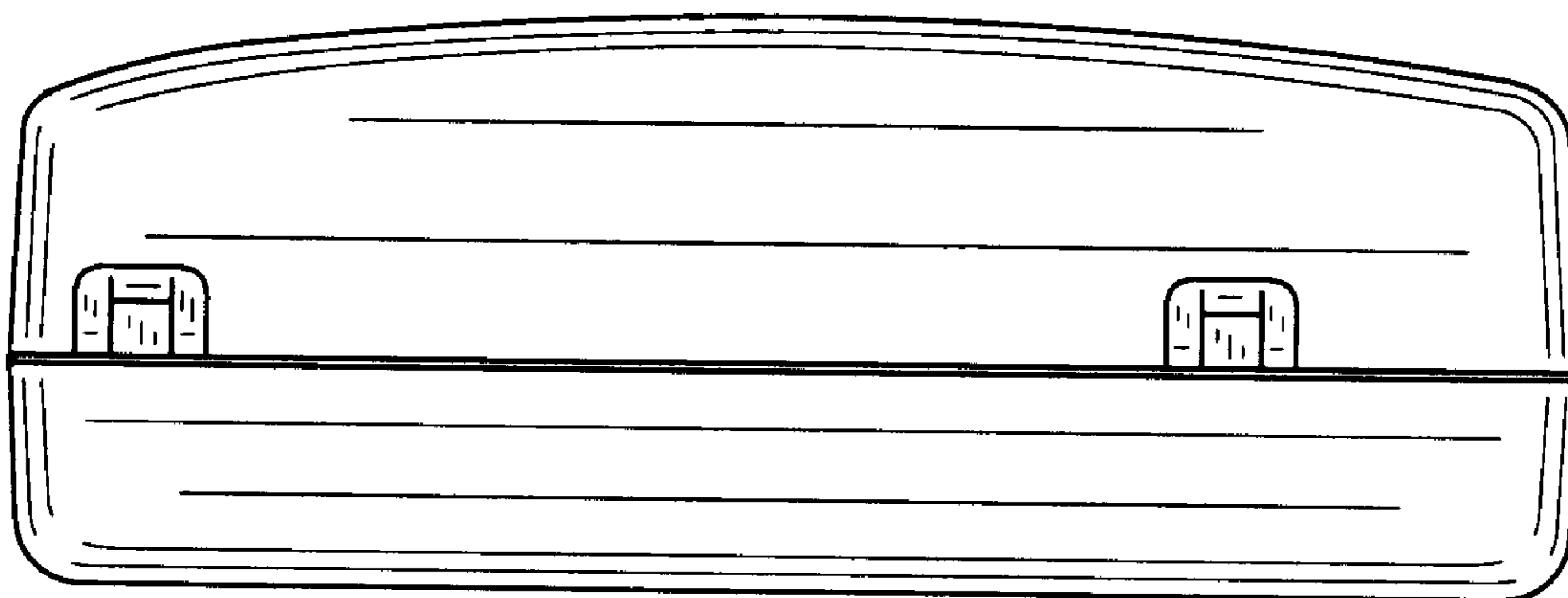

Fig.7

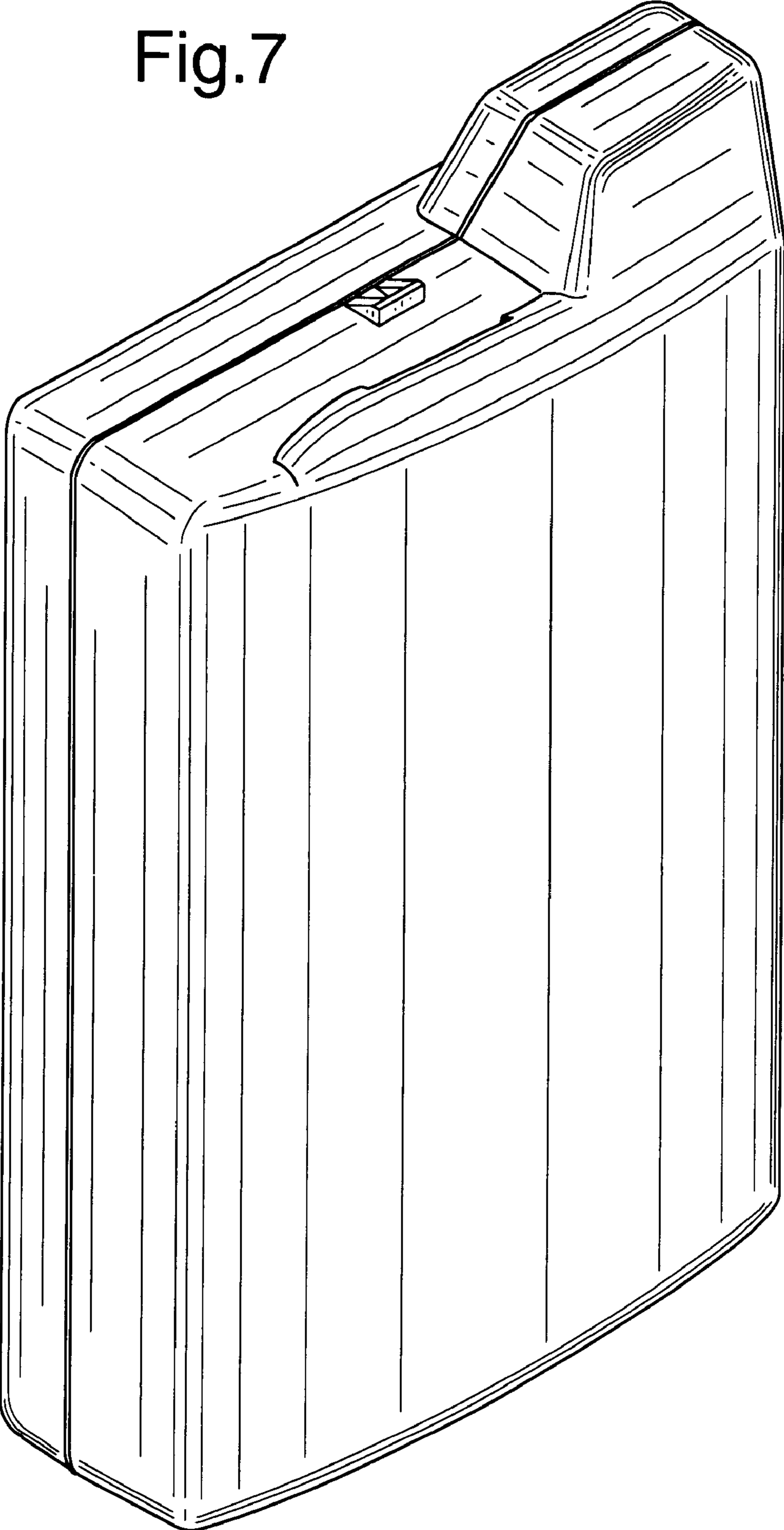

Fig.8

