



US00D526559S

(12) **United States Design Patent**
Lewis

(10) **Patent No.:** **US D526,559 S**

(45) **Date of Patent:** **** Aug. 15, 2006**

(54) **TARP, TENT AND FABRIC ROLLER CLIP**

(75) Inventor: **John W. Lewis**, 10835 N. 5th St.,
Yukon, OK (US) 73099

(73) Assignee: **John W. Lewis**, Oke, OK (US)

(**) Term: **14 Years**

(21) Appl. No.: **29/185,698**

(22) Filed: **Jul. 1, 2003**

(51) **LOC (8) Cl.** **08-08**

(52) **U.S. Cl.** **D8/395**

(58) **Field of Classification Search** D8/356,
D8/371, 394-396; 248/72.2, 215, 227.1,
248/49, 300, 301, 316.7, 51, 489; 24/22,
24/67 R, 20 S, 115 R, 546, 563, 343; D19/65;
D21/839; 135/119-120.4

See application file for complete search history.

(56) **References Cited**

U.S. PATENT DOCUMENTS

1,589,076	A	*	6/1926	Haskins	24/483
2,471,186	A	*	5/1949	Ashcroft	24/560
2,675,593	A	*	4/1954	Okell	24/459
D246,141	S		10/1977	Mazur		
4,536,924	A	*	8/1985	Willoughby	24/487
D288,162	S		2/1987	Hutton		

4,686,748	A		8/1987	Kaivanto		
4,688,304	A		8/1987	Marcott		
D302,241	S		7/1989	Solbeck		
D339,521	S		9/1993	Bartlett		
D362,176	S		9/1995	Solbeck		
D366,607	S		1/1996	Holmgren		
5,507,246	A	*	4/1996	Rand, Jr.	116/137 R
6,266,854	B1	*	7/2001	Ancona et al.	24/499
6,416,028	B1	*	7/2002	Miller et al.	248/339

* cited by examiner

Primary Examiner—Louis S. Zarfaz
Assistant Examiner—John Windmuller

(57) **CLAIM**

The ornamental design for a tarp, tent and fabric roller clip,
as shown and described.

DESCRIPTION

FIG. 1 is a right side elevational view of a tarp, tent and fabric roller clip showing my new design;
FIG. 2 is a left side elevational view thereof;
FIG. 3 is a top plan view thereof;
FIG. 4 is a bottom plan view thereof;
FIG. 5 is a front elevational view thereof;
FIG. 6 is a rear elevational view thereof; and,
FIG. 7 is a right side cross-sectional view thereof.

1 Claim, 2 Drawing Sheets

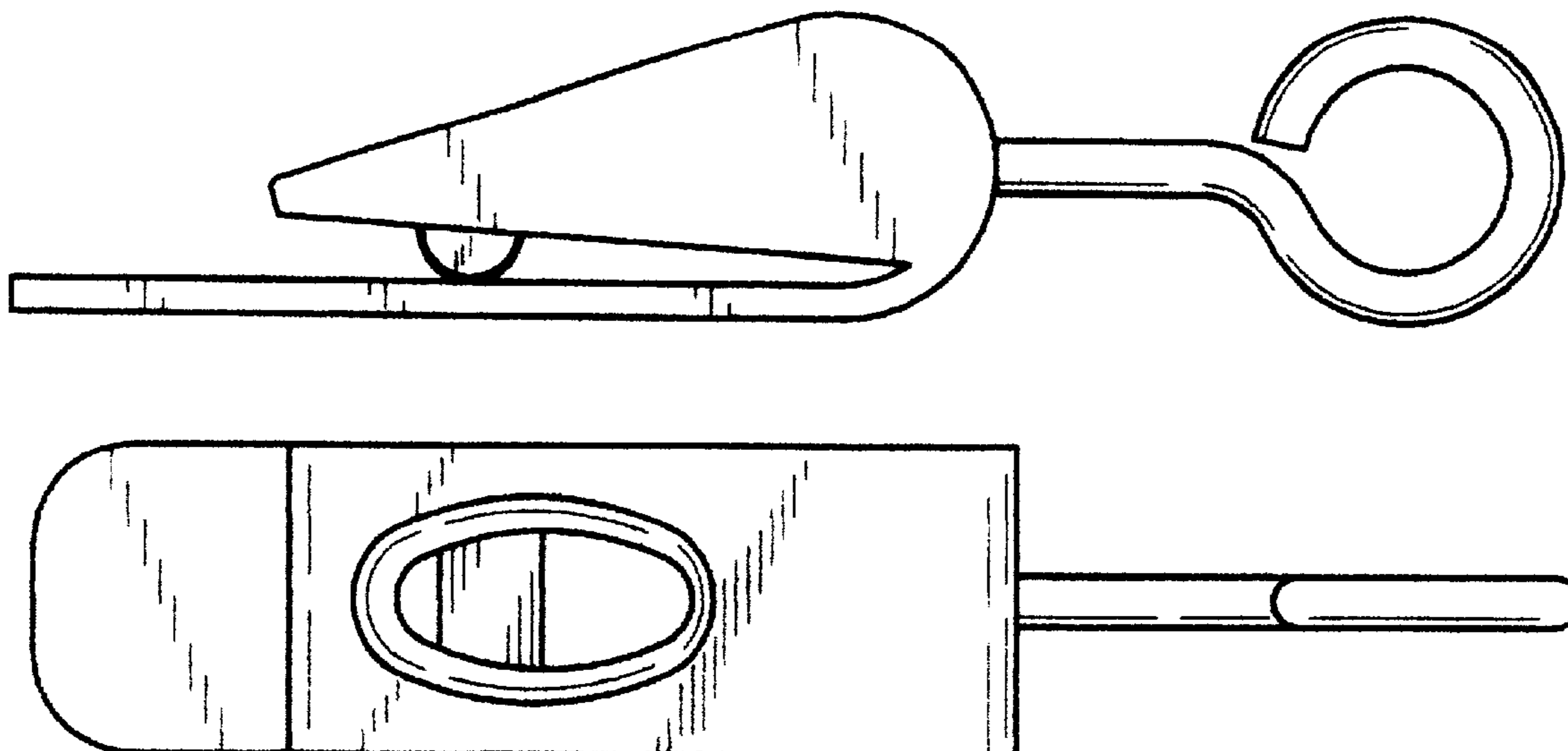

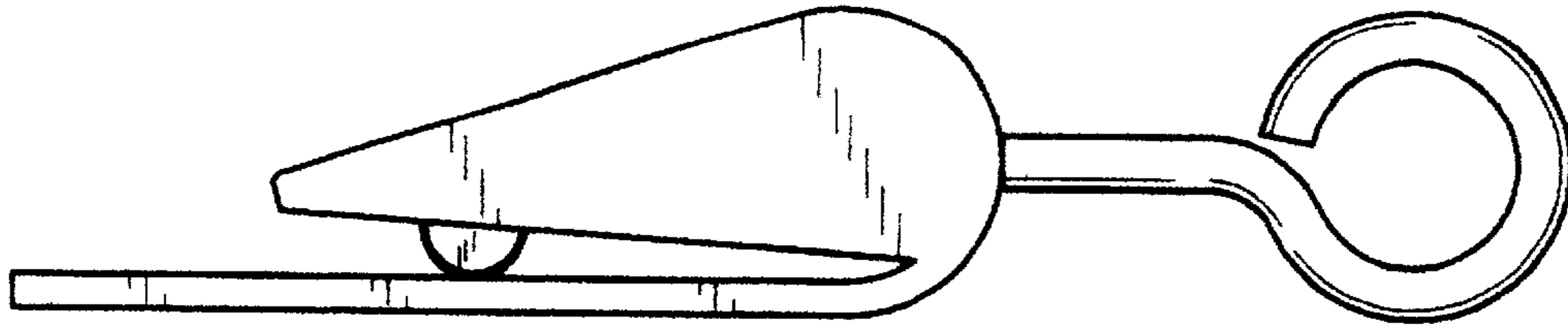

FIG 1

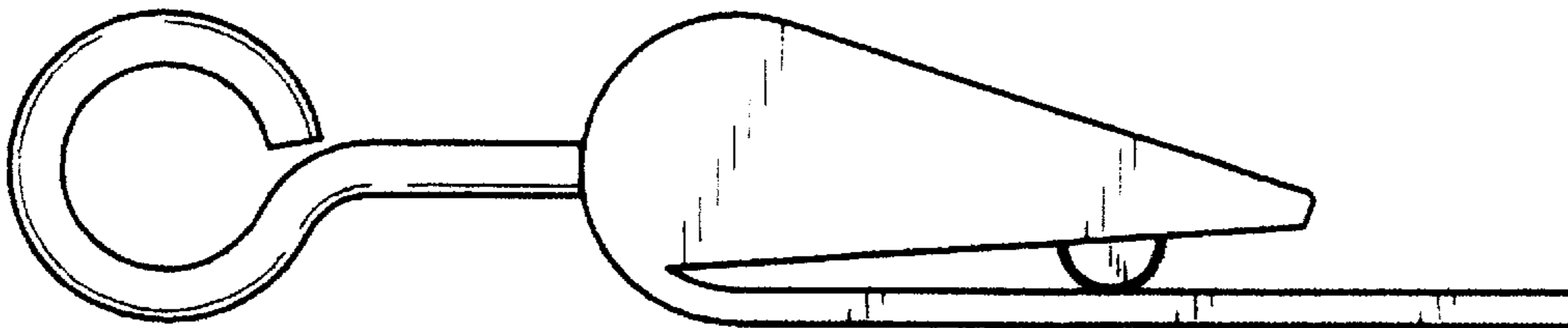

FIG 2

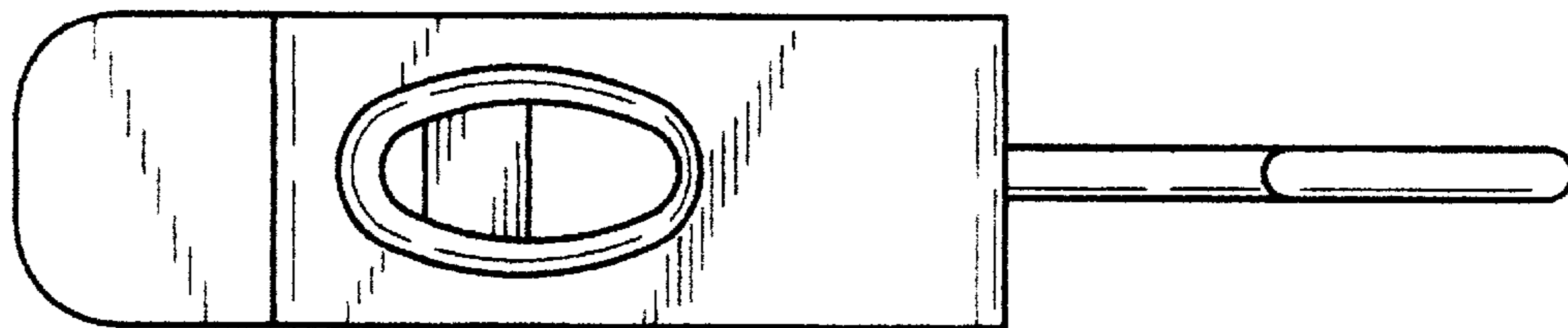

FIG 3

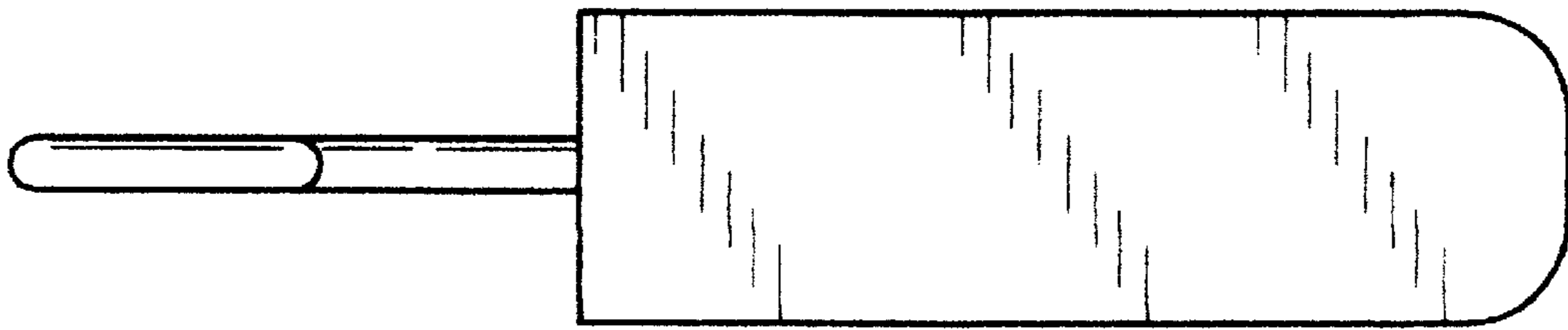

FIG 4

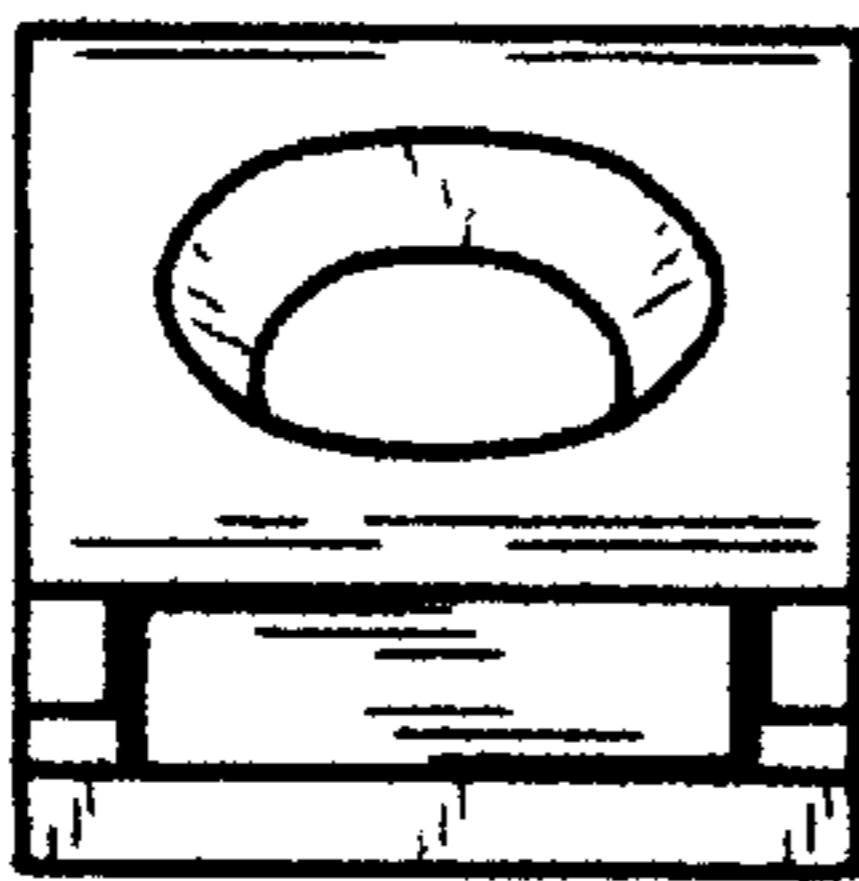

FIG 5

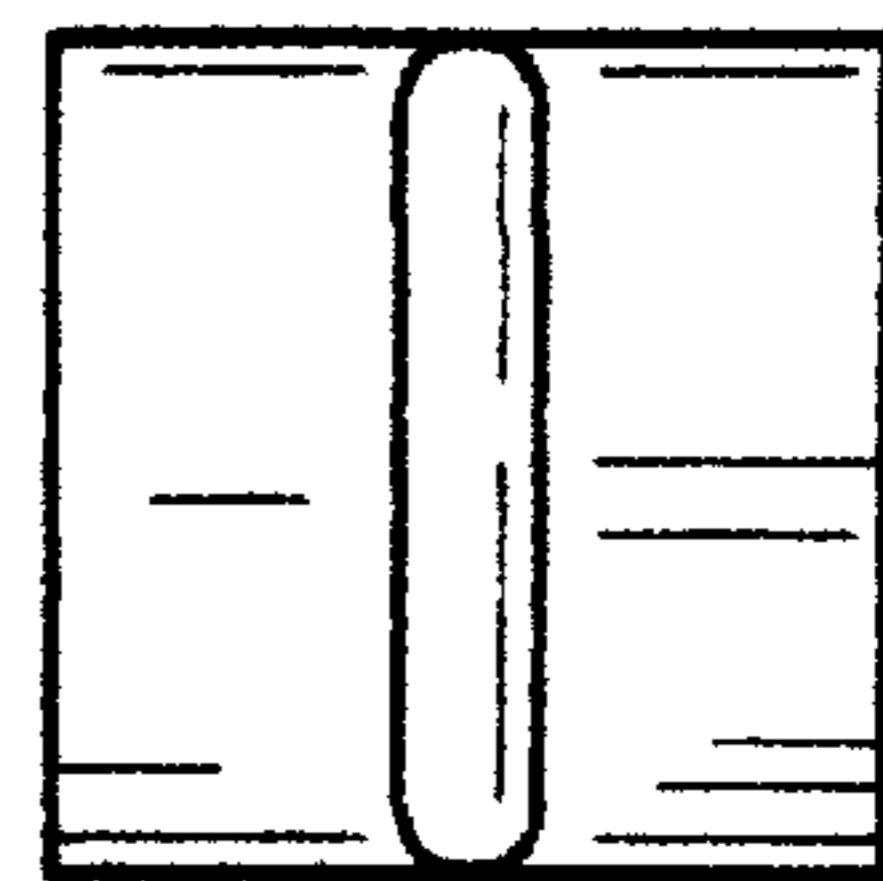

FIG 6

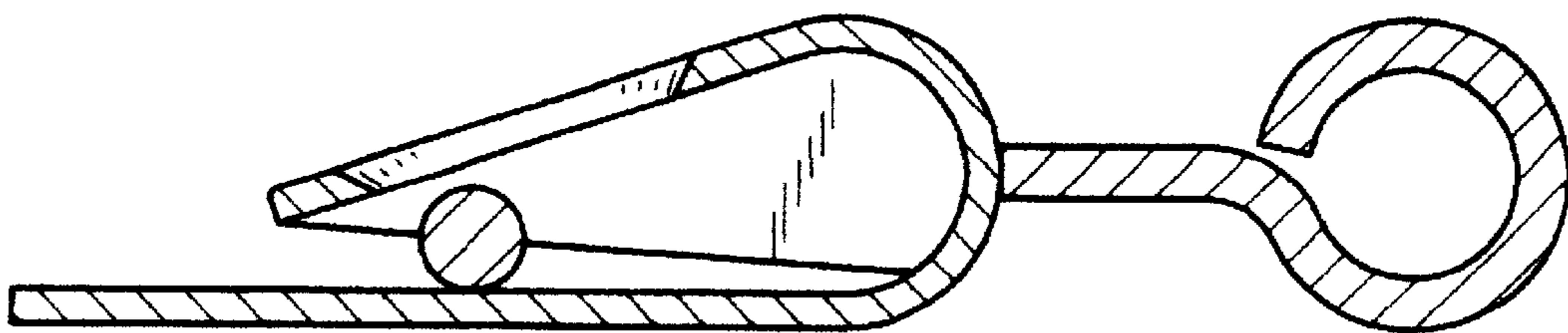

FIG 7