



US00D526548S

(12) **United States Design Patent**  
**Aglassinger**

(10) **Patent No.:** **US D526,548 S**

(45) **Date of Patent:** **\*\* Aug. 15, 2006**

(54) **SANDER**

(75) Inventor: **Hans-Peter Aglassinger**, Esslingen  
(DE)

(73) Assignee: **Robert Bosch GmbH**, Stuttgart (DE)

(\*\*) Term: **14 Years**

(21) Appl. No.: **29/228,788**

(22) Filed: **Apr. 28, 2005**

(30) **Foreign Application Priority Data**

Feb. 22, 2005 (DE) ..... 4 05 01 033

(51) **LOC (8) Cl.** ..... **08-01**

(52) **U.S. Cl.** ..... **D8/62**

(58) **Field of Classification Search** ..... D8/67,  
D8/62, 61; D32/15, 17, 3, 19, 68, 69, 50,  
D32/75; D4/102; 451/359, 358, 357, 356,  
451/355, 354, 353, 351, 344, 456, 451  
See application file for complete search history.

(56) **References Cited**

**U.S. PATENT DOCUMENTS**

- D230,458 S \* 2/1974 Hall ..... D32/69
- D245,473 S \* 8/1977 Heninger ..... D32/50
- D374,386 S \* 10/1996 Bosten et al. .... D8/62
- D417,050 S \* 11/1999 Reede ..... D32/50

- D447,397 S \* 9/2001 Netzler ..... D8/62
- D453,460 S \* 2/2002 Lui ..... D8/62
- 6,379,237 B1 \* 4/2002 Gordon ..... 451/523
- D459,965 S \* 7/2002 Pretzell ..... D8/62
- D460,232 S \* 7/2002 Weihrauch ..... D32/50
- D468,878 S \* 1/2003 Reede ..... D32/50
- D473,987 S \* 4/2003 Foersterling ..... D32/35
- D503,599 S \* 4/2005 Wu ..... D8/62
- D511,954 S \* 11/2005 Heun ..... D8/62

\* cited by examiner

*Primary Examiner*—Cathron C. Brooks

*Assistant Examiner*—Austin Murphy

(74) *Attorney, Agent, or Firm*—Michael J. Striker

(57) **CLAIM**

The ornamental design for a sander, as shown and described.

**DESCRIPTION**

FIG. 1 is a top perspective view of a sander showing my new design;

FIG. 2 is a rear view thereof;

FIG. 3 is a side view thereof;

FIG. 4 is a front view thereof;

FIG. 5 is the opposite side view from FIG. 3 thereof;

FIG. 6 is a bottom view thereof; and,

FIG. 7 is a top view thereof.

**1 Claim, 7 Drawing Sheets**

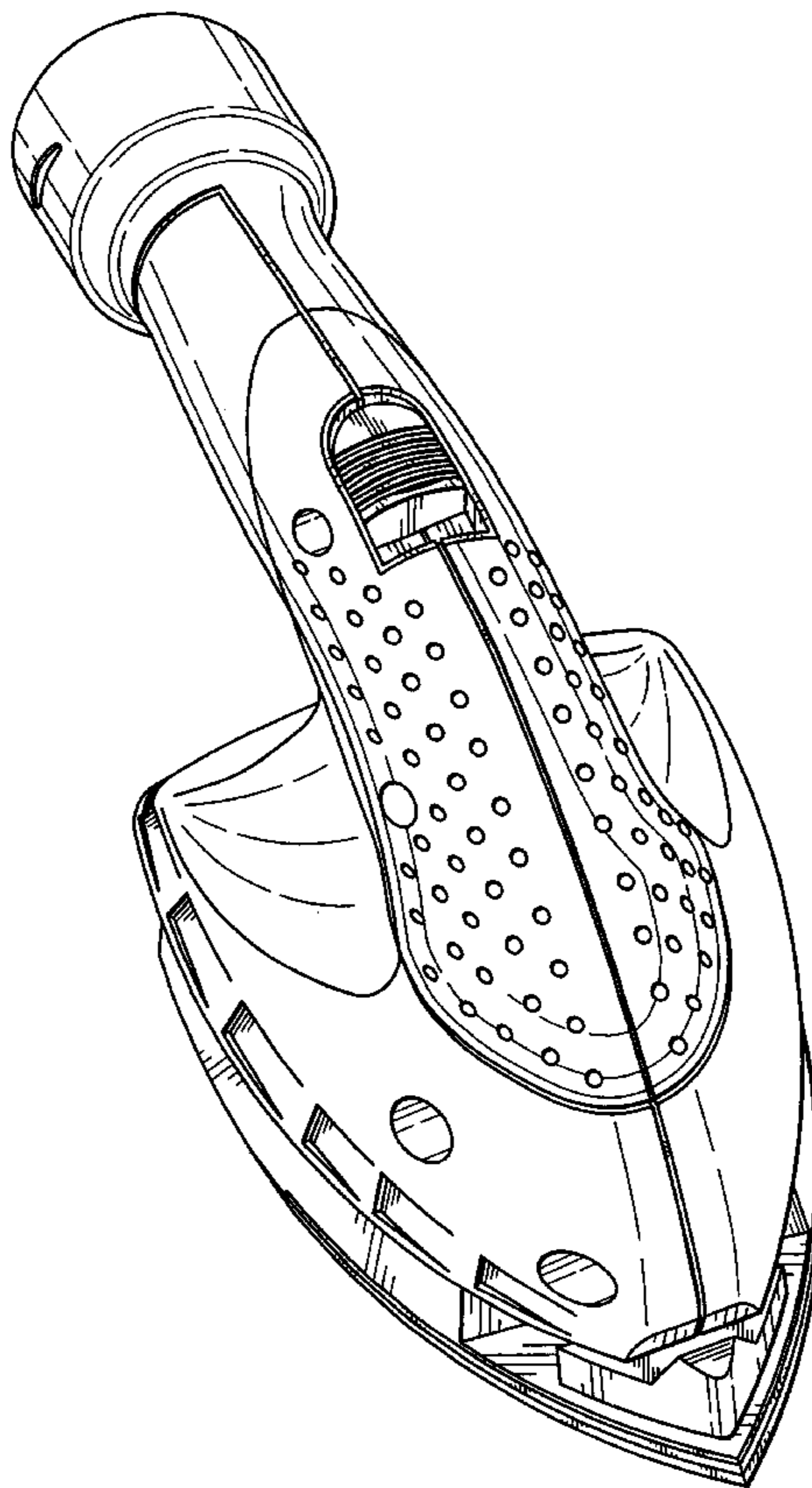

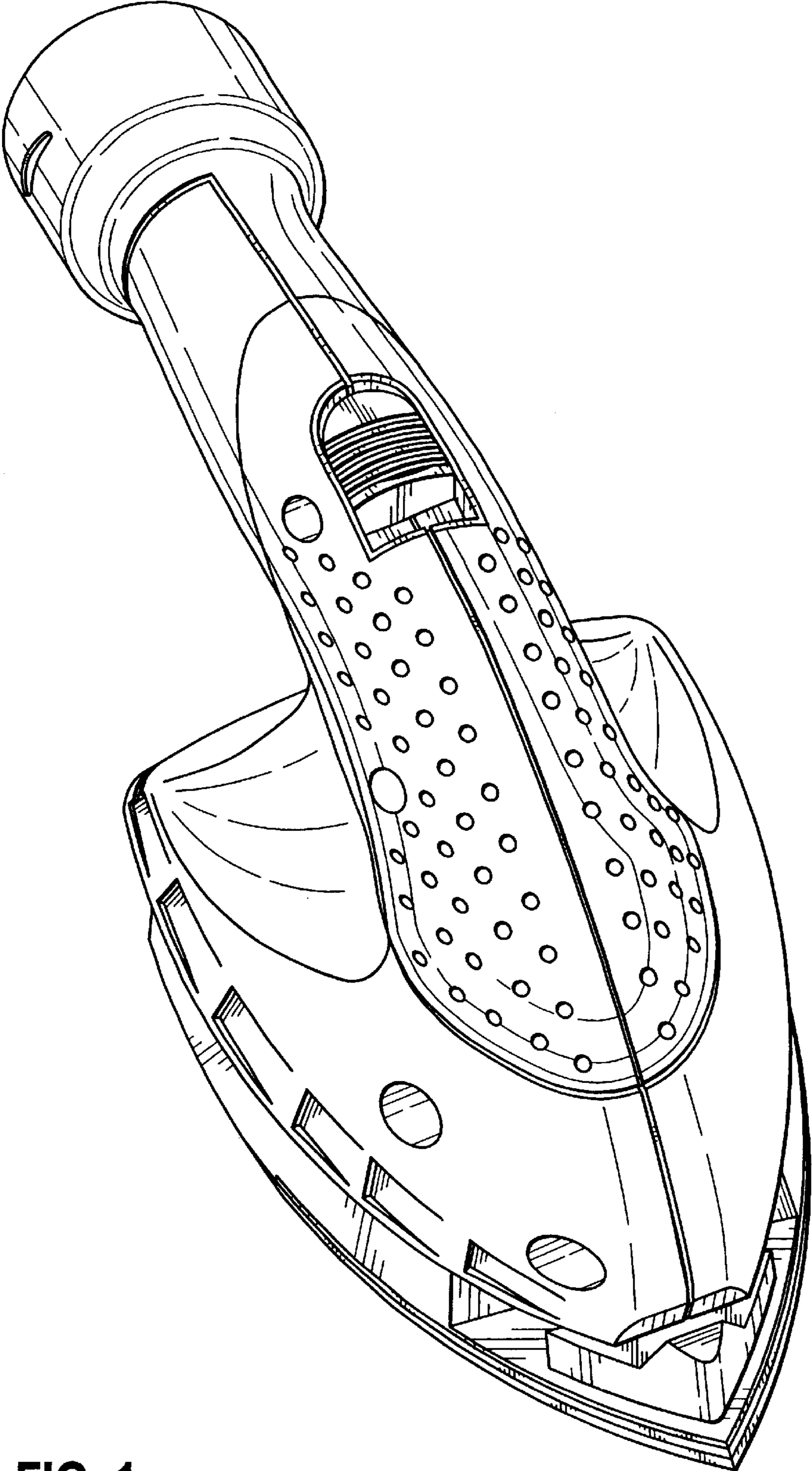
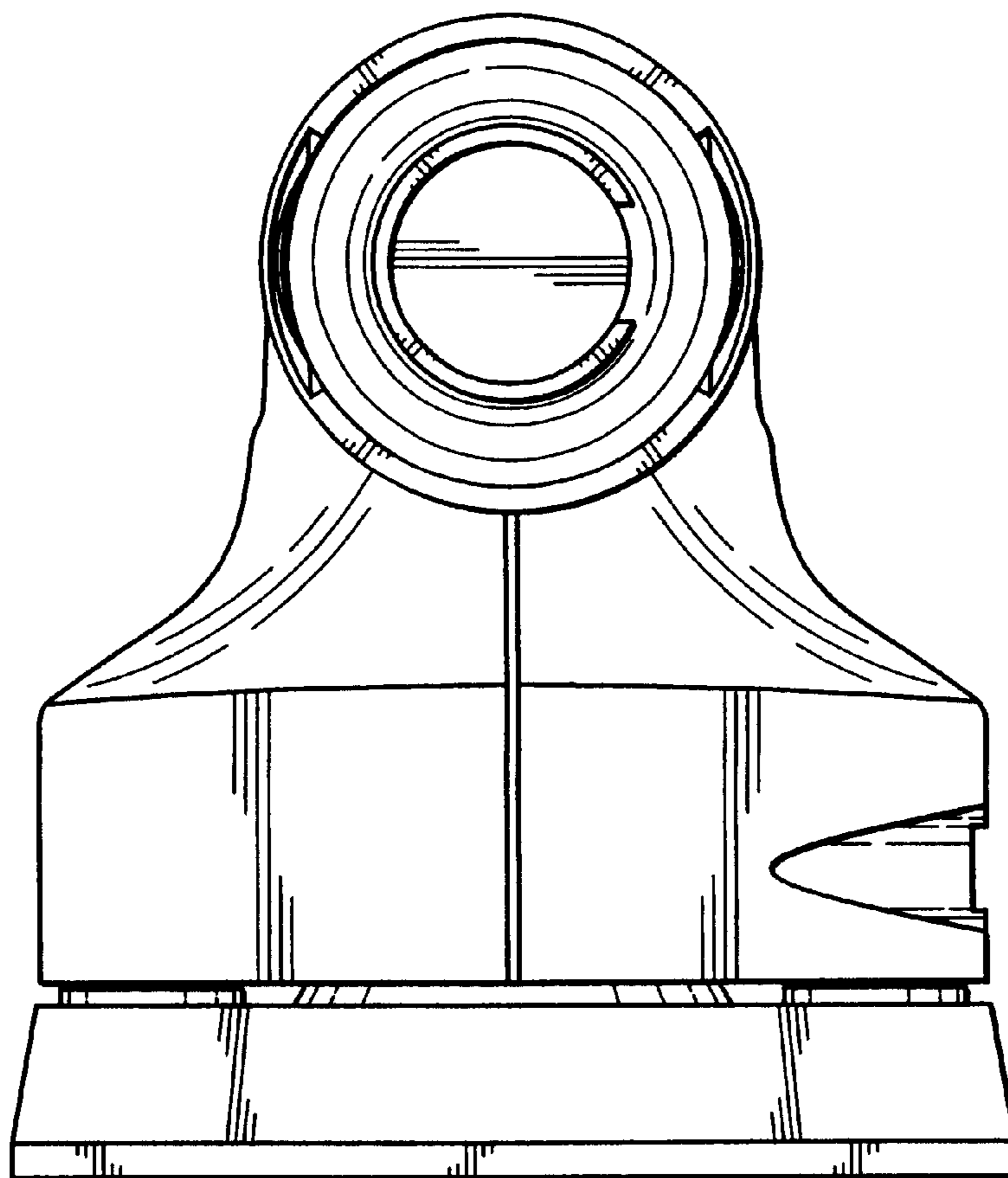

FIG. 1



**FIG. 2**

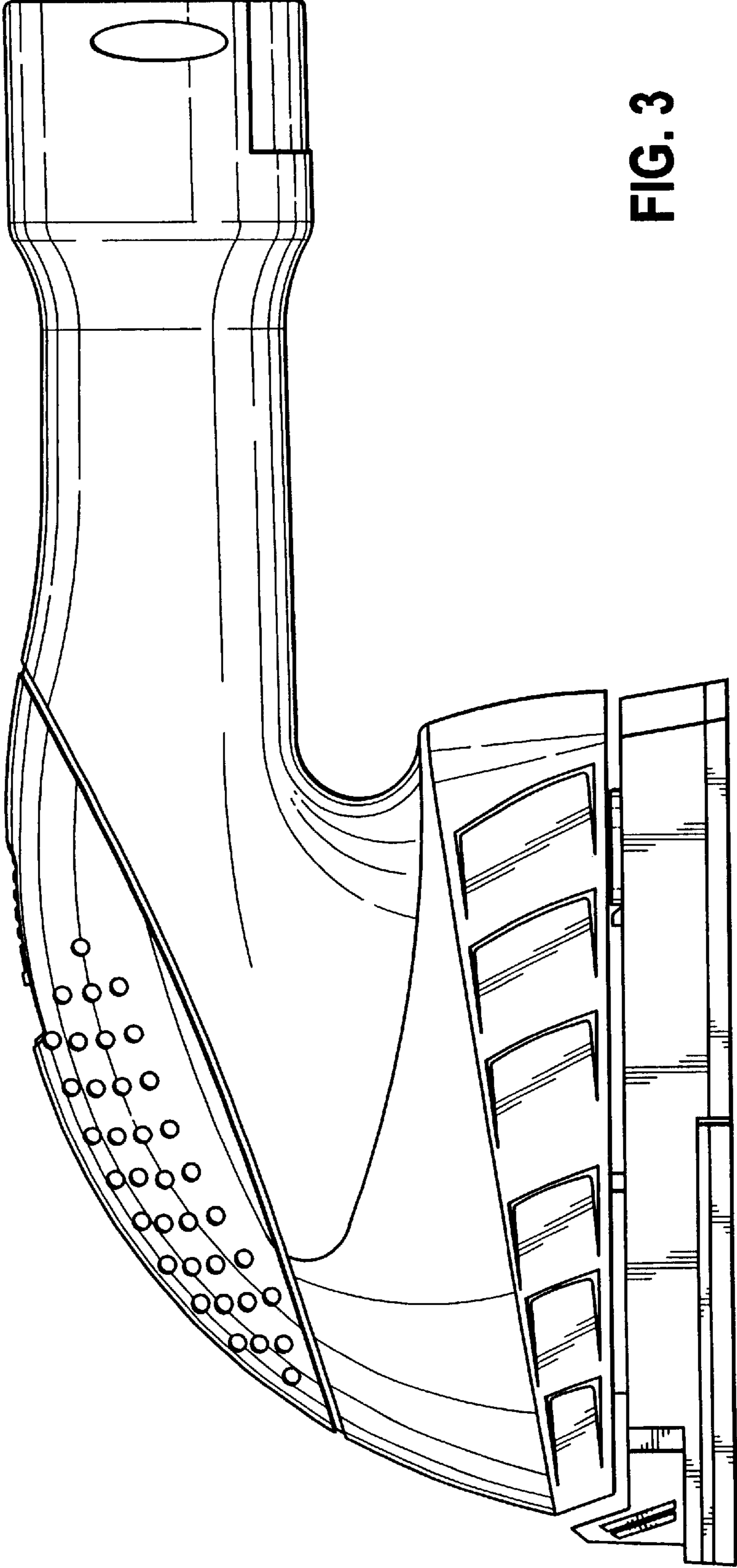

FIG. 3

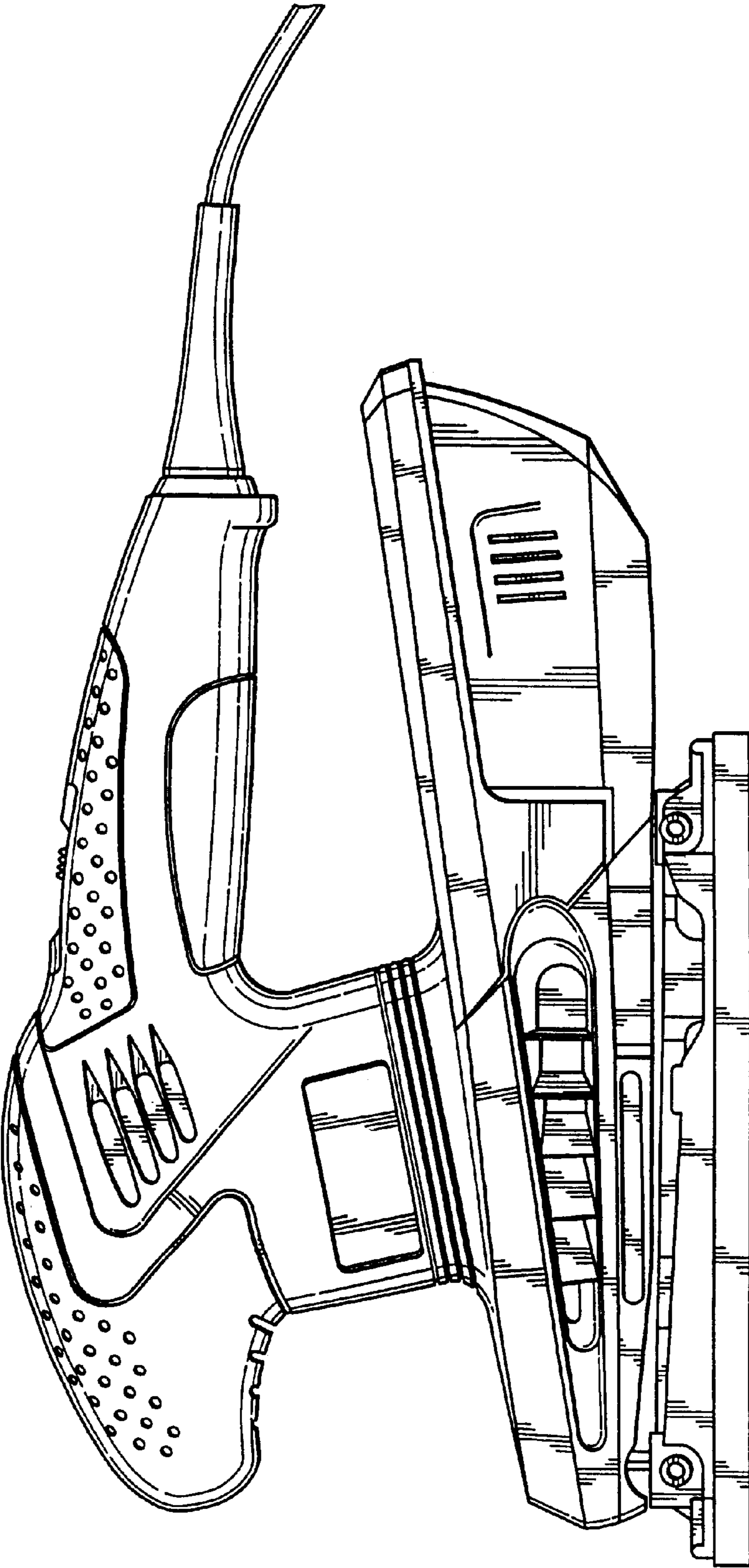

FIG. 4

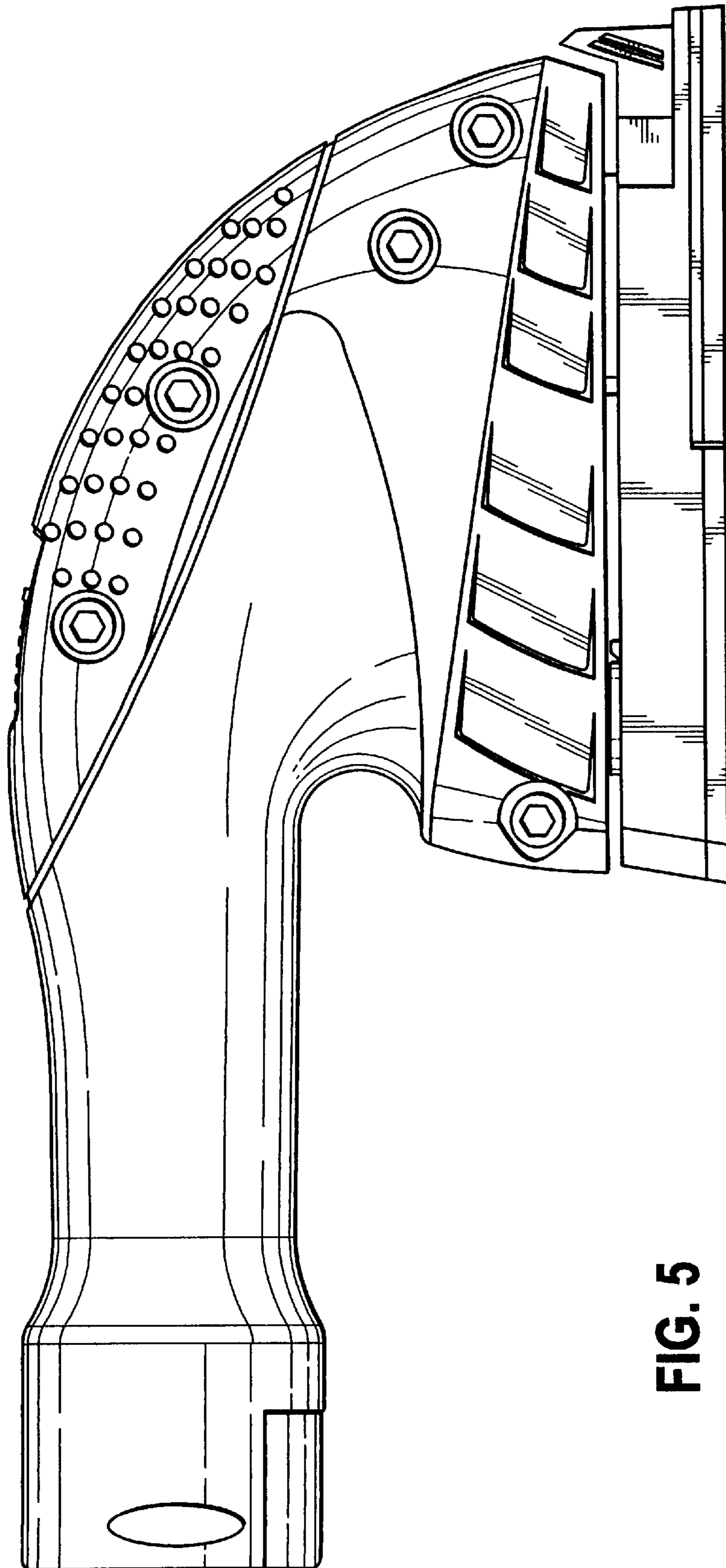

FIG. 5

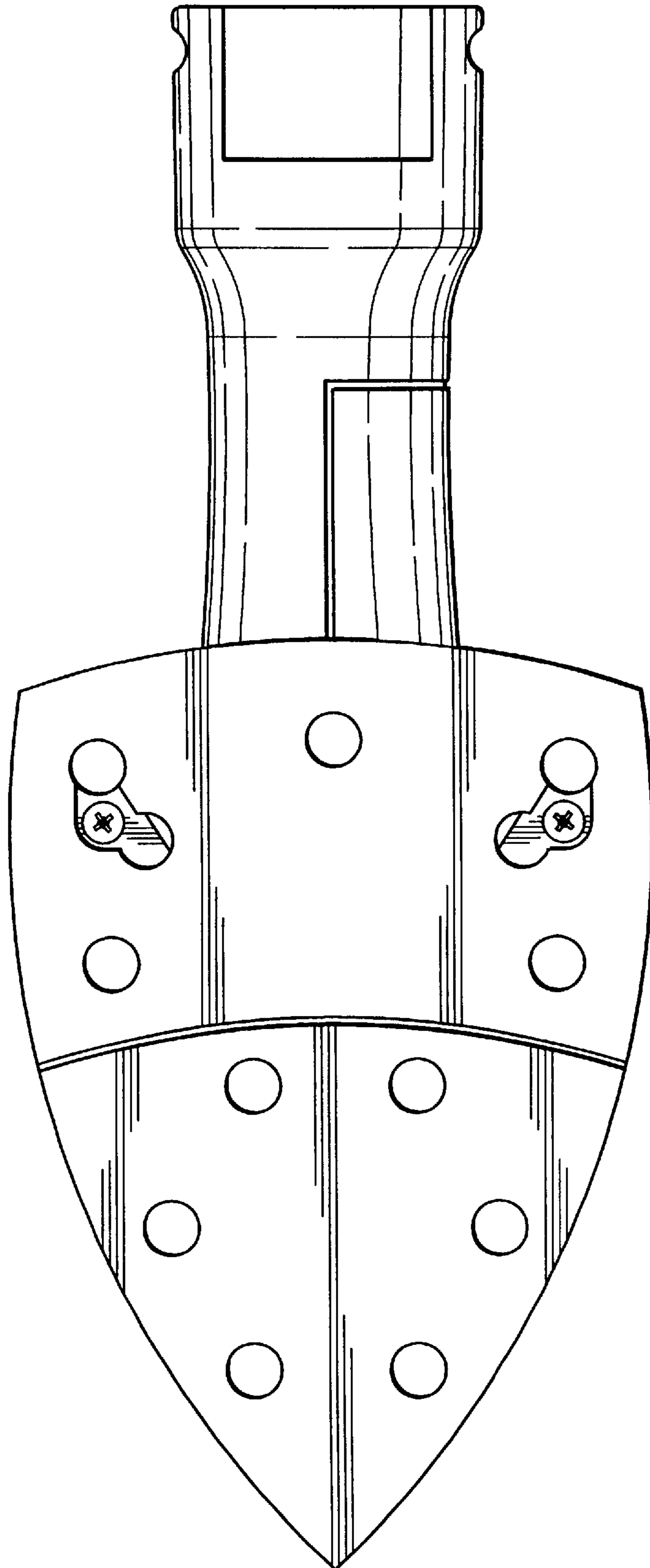

FIG. 6

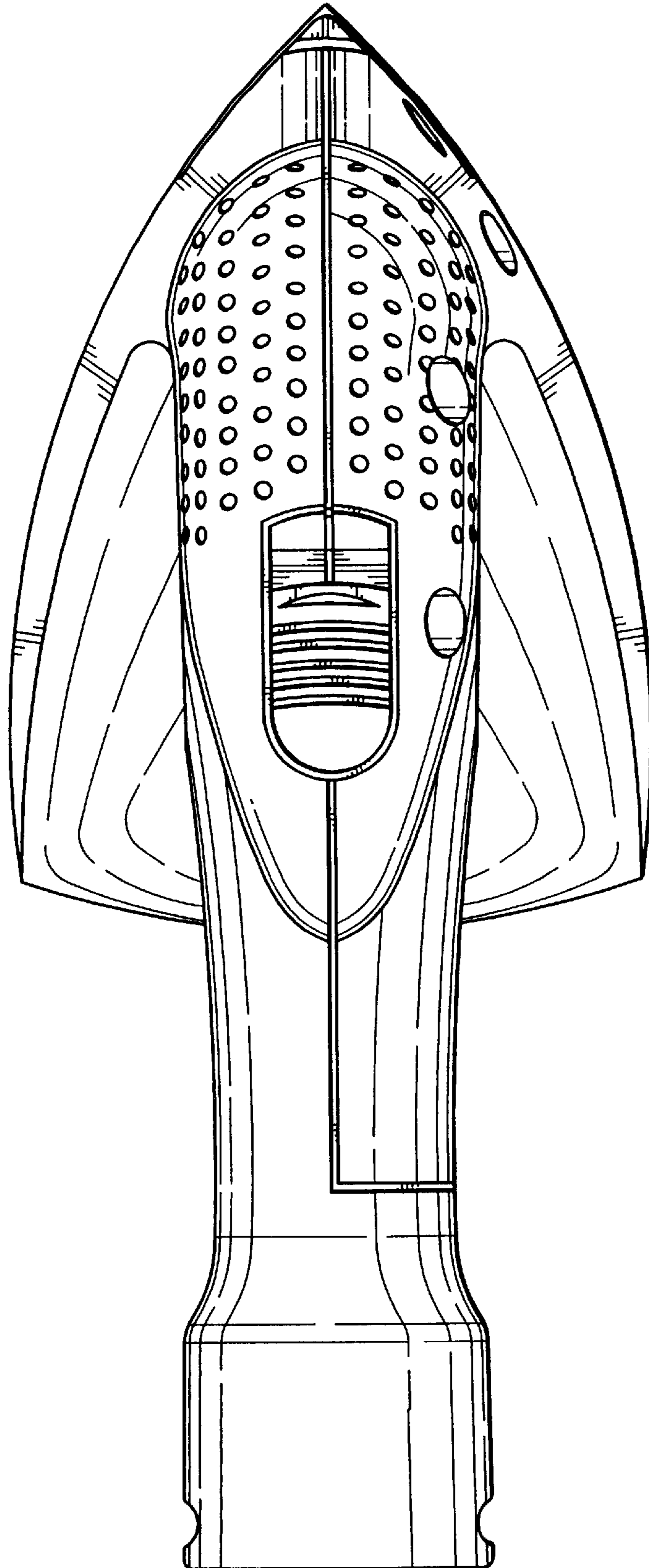

FIG. 7



UNITED STATES PATENT AND TRADEMARK OFFICE  
**CERTIFICATE OF CORRECTION**

PATENT NO. : Des. 526,548 S  
APPLICATION NO. : 29/228788  
DATED : August 15, 2006  
INVENTOR(S) : H-P. Aglassinger

Page 1 of 2

It is certified that error appears in the above-identified patent and that said Letters Patent is hereby corrected as shown below:

Delete Fig. 4 and substitute correct Fig. 4 attached hereto.

Signed and Sealed this

First Day of May, 2007

A handwritten signature in black ink on a light gray dotted background. The signature reads "Jon W. Dudas" in a cursive style.

JON W. DUDAS

*Director of the United States Patent and Trademark Office*

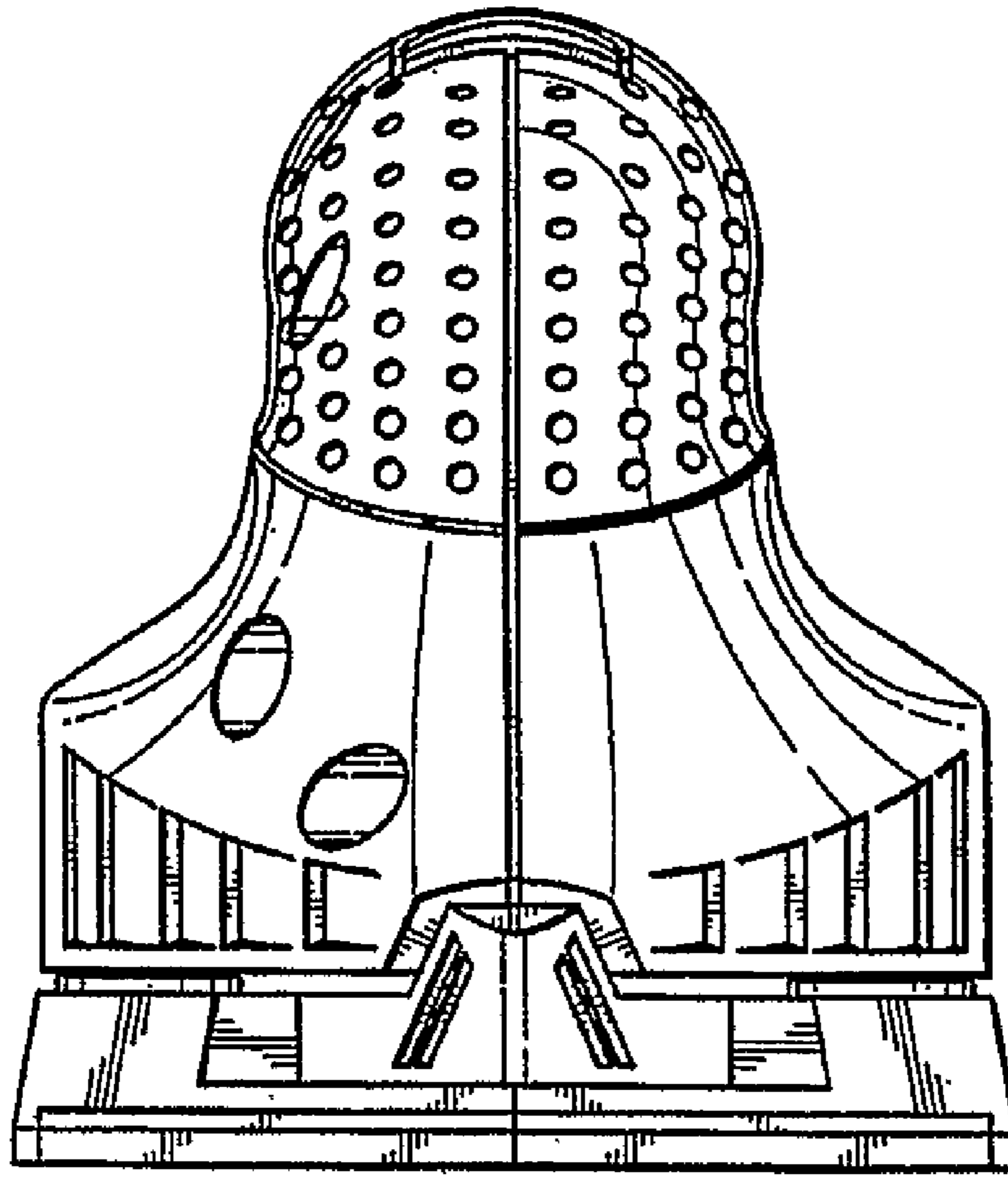

FIG. 4