



US00D526504S

(12) **United States Design Patent** (10) **Patent No.:** **US D526,504 S**  
**Peterson et al.** (45) **Date of Patent:** **\*\* \*Aug. 15, 2006**

(54) **CHAIR**

(75) Inventors: **Dale Peterson**, New York, NY (US);  
**Jonsara Ruth**, Brooklyn, NY (US);  
**Stacy Mar**, New York, NY (US)

(73) Assignee: **Martha Stewart Living Omnimedia, Inc.**, New York, NY (US)

(\*) Notice: This patent is subject to a terminal disclaimer.

(\*\*) Term: **14 Years**

(21) Appl. No.: **29/188,558**

(22) Filed: **Aug. 19, 2003**

(51) **LOC (8) Cl.** ..... **06-01**

(52) **U.S. Cl.** ..... **D6/380**; D6/380

(58) **Field of Classification Search** ..... D6/334-336,  
D6/371-374, 379-380, 500-502; 297/445.1,  
297/446.1, 447.1

See application file for complete search history.

(56) **References Cited**

**U.S. PATENT DOCUMENTS**

D111,906 S	*	10/1938	Davis et al.	.....	D6/380
D152,895 S	*	3/1949	Lubberts et al.	.....	D6/379
D369,693 S	*	5/1996	Huang	.....	D6/380
D395,758 S	*	7/1998	Hutton	.....	D6/334
D396,759 S	*	8/1998	Duenkelsbuehler	.....	D6/370
D408,644 S	*	4/1999	Muller	.....	D6/376
D431,120 S	*	9/2000	Hazen et al.	.....	D6/370

**OTHER PUBLICATIONS**

No. 1004 Regency Back Chair. Liberty Chair Corp. Catalog.\*  
Photo (1) of chair at Greene Street Antique in New York taken on Mar. 5, 2002.

Drawing of chair, drawing shown in May 2002 at the Bernhardt showroom, IHFC Building, 210 E Commerce Ave, High Point, NC 27260—one sheet.

\* cited by examiner

*Primary Examiner*—Mimosa De

(74) *Attorney, Agent, or Firm*—Kenyon & Kenyon LLP

(57) **CLAIM**

The ornamental design for a chair, as shown and described.

**DESCRIPTION**

FIG. 1 is a front perspective view of a first embodiment of a chair showing our new design;

FIG. 2 is a front view thereof;

FIG. 3 is a left side view thereof, the right side view being a mirror image thereof;

FIG. 4 is a back view thereof;

FIG. 5 is a top view thereof;

FIG. 6 is a front perspective view of a second embodiment of a chair showing our new design;

FIG. 7 is a front view thereof;

FIG. 8 is a left side view thereof, the right side view being a mirror image thereof;

FIG. 9 is a back view thereof; and,

FIG. 10 is a top view thereof.

The broken line portions are for illustrative purposes only and form no part of the claimed design.

**1 Claim, 10 Drawing Sheets**

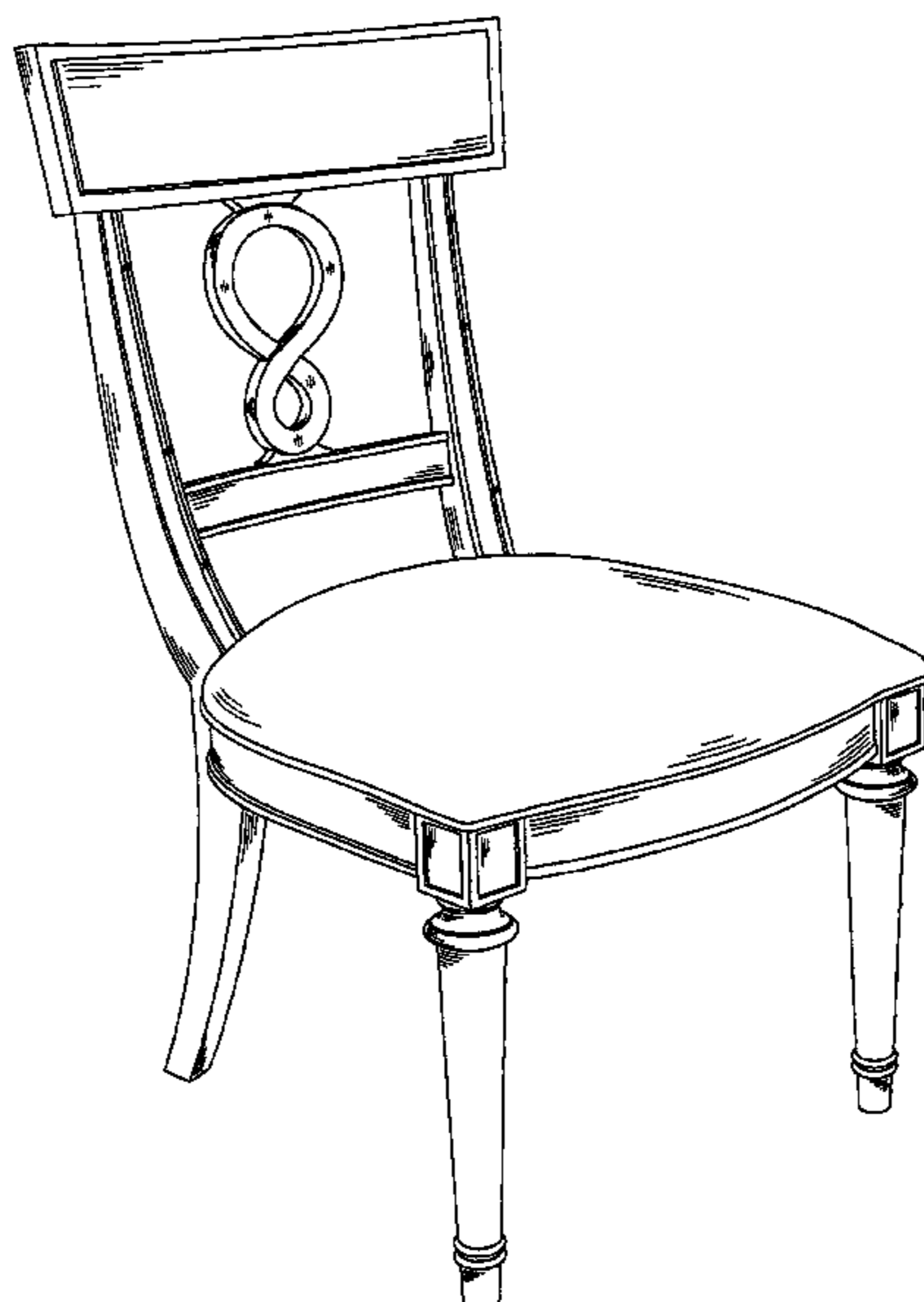

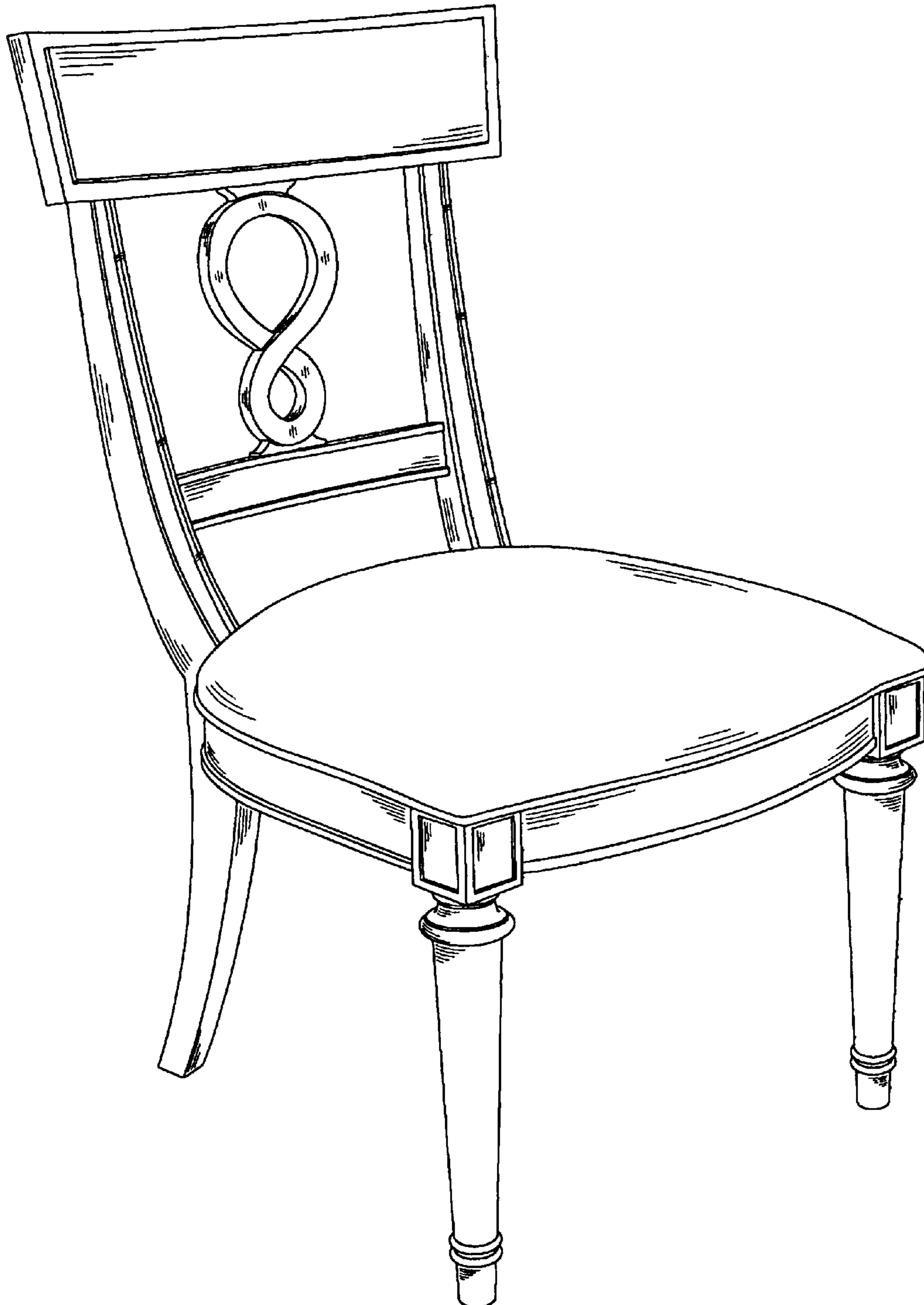

FIG. 1

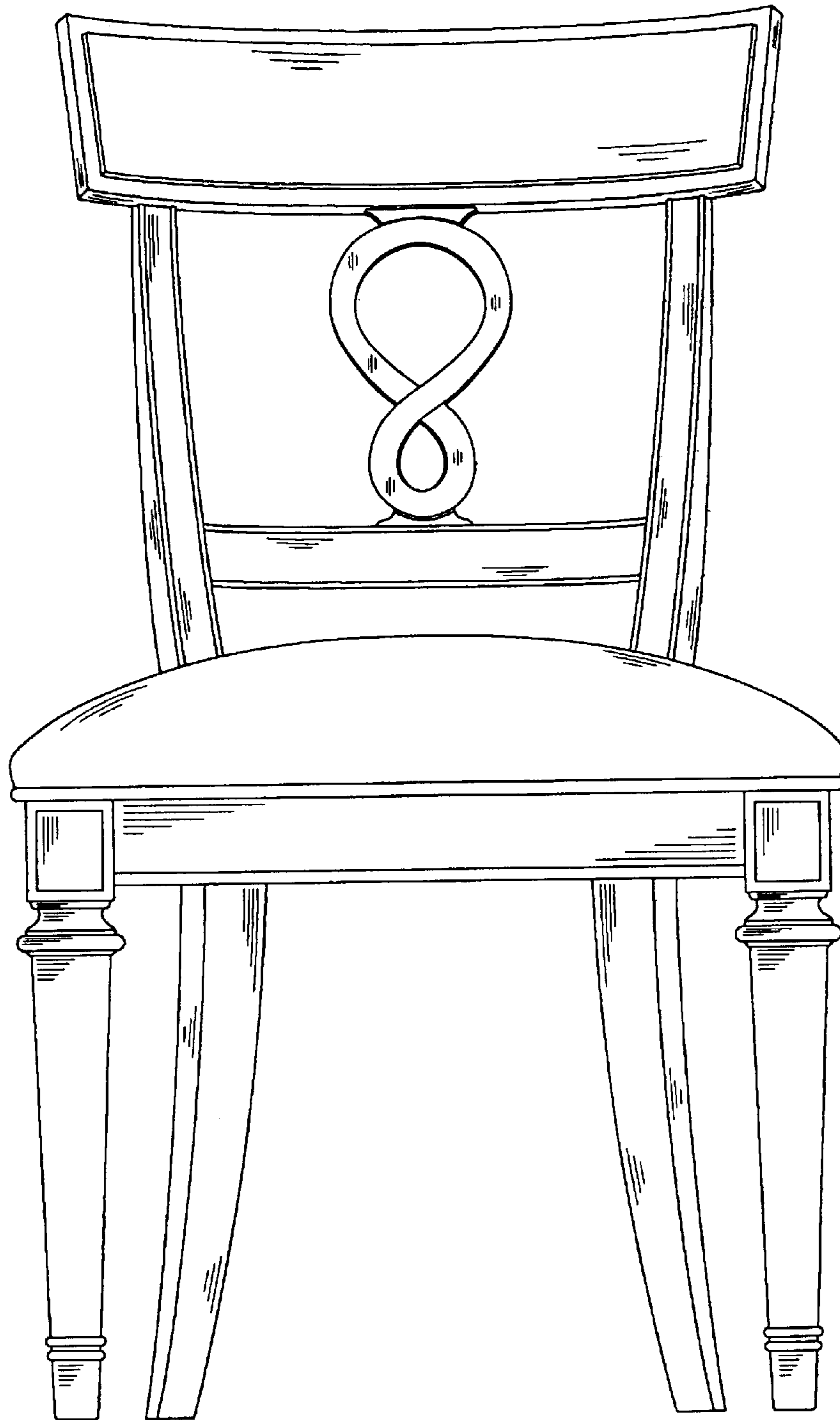

FIG. 2

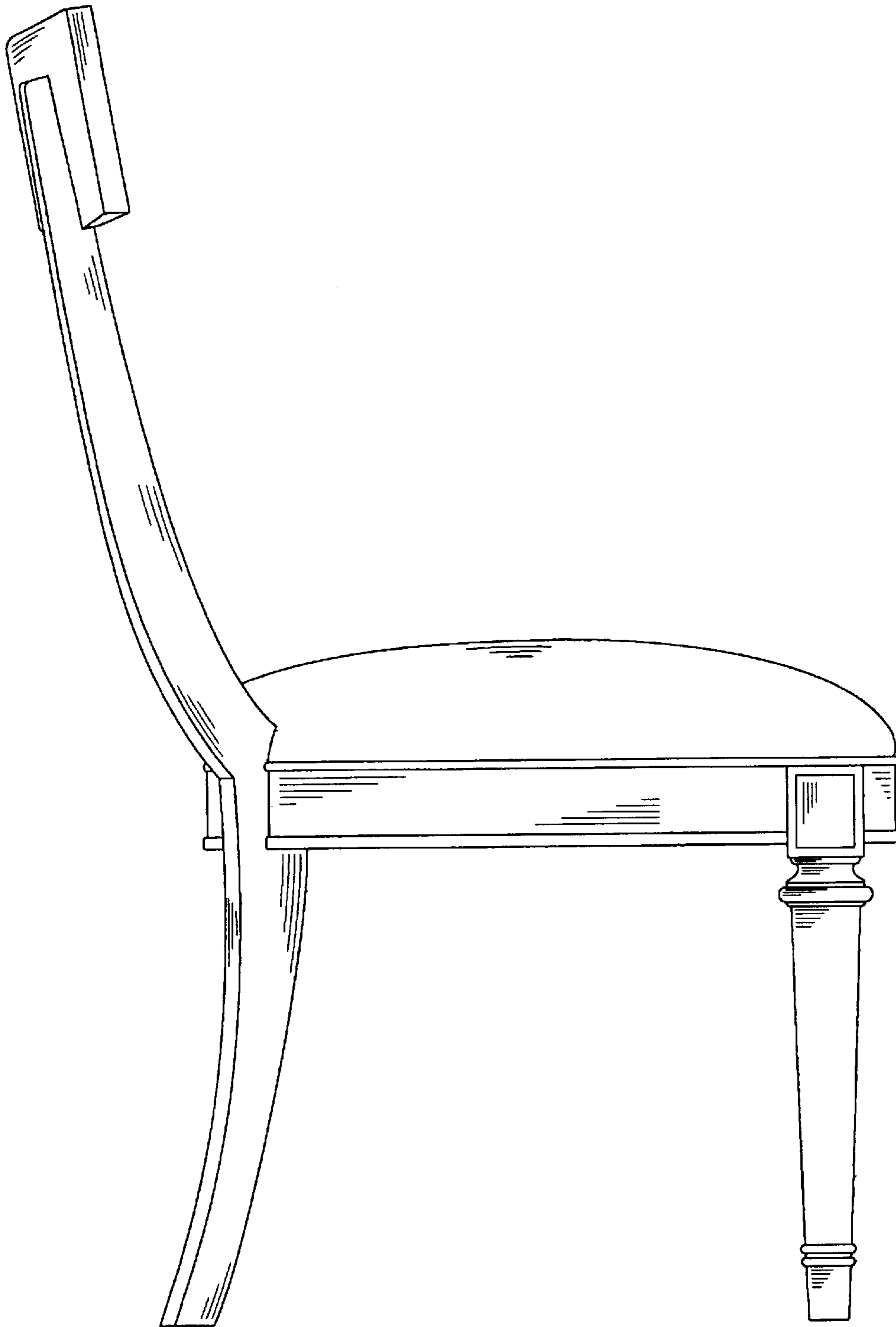

FIG. 3

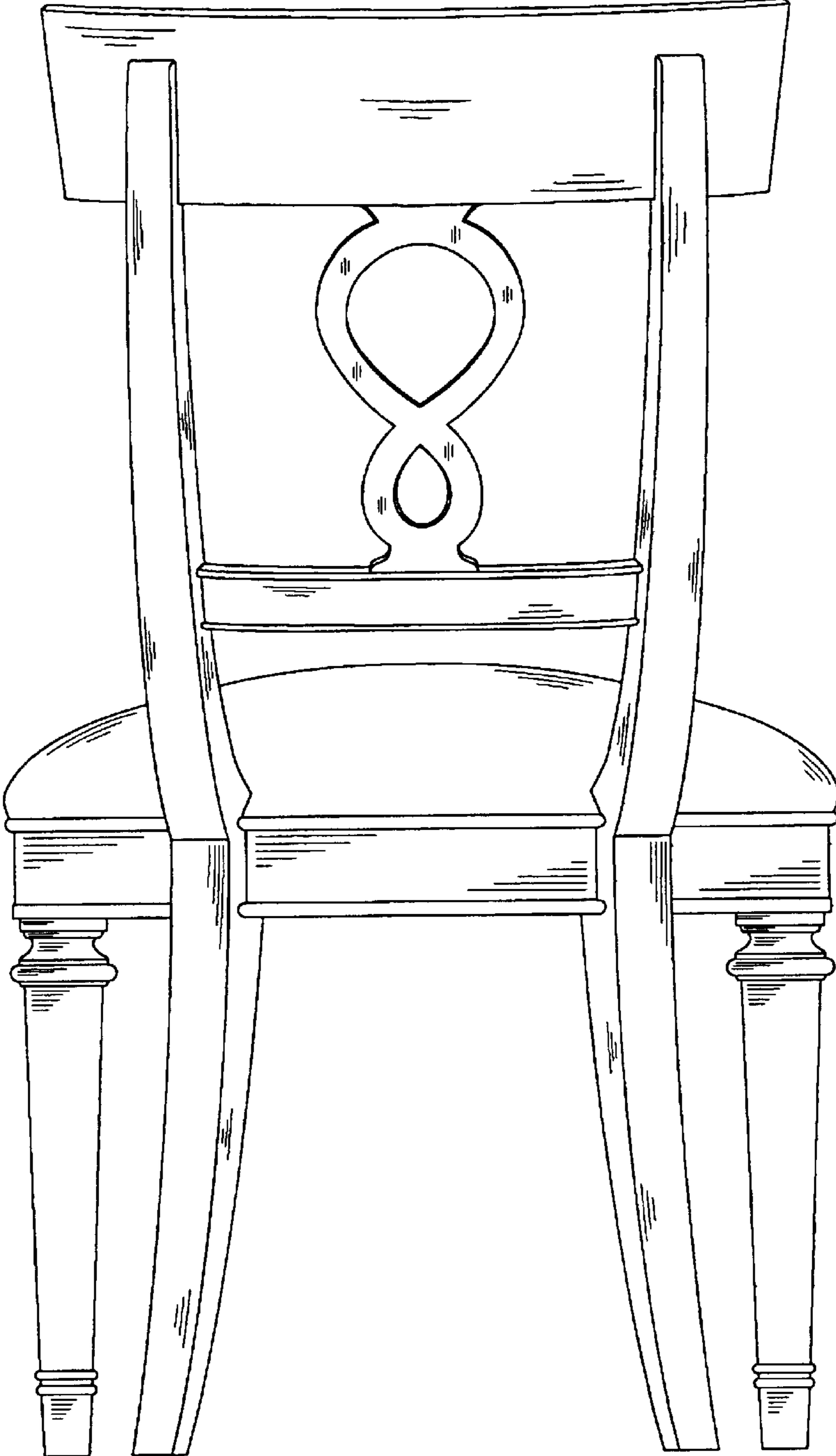

FIG. 4

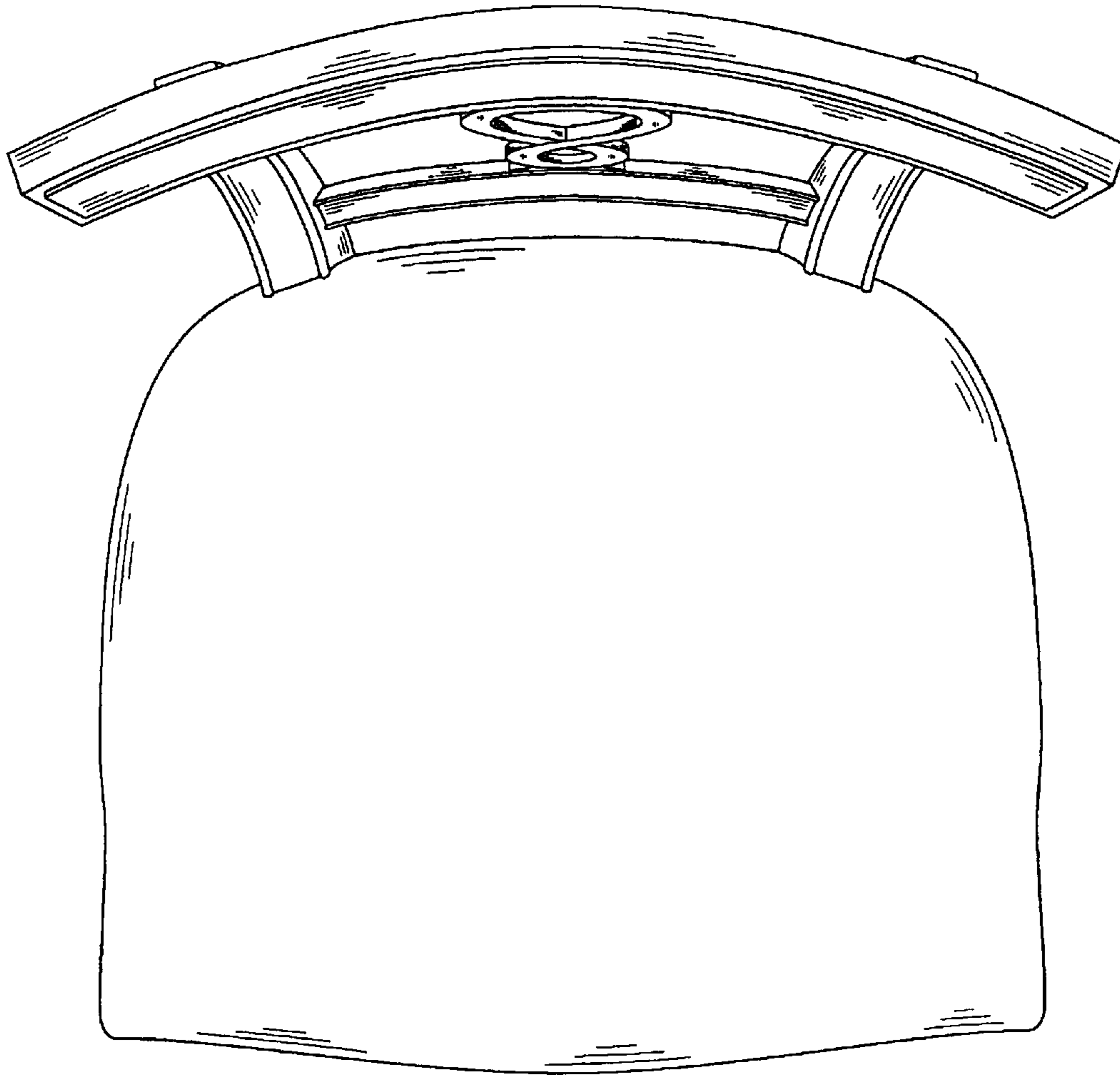

FIG. 5

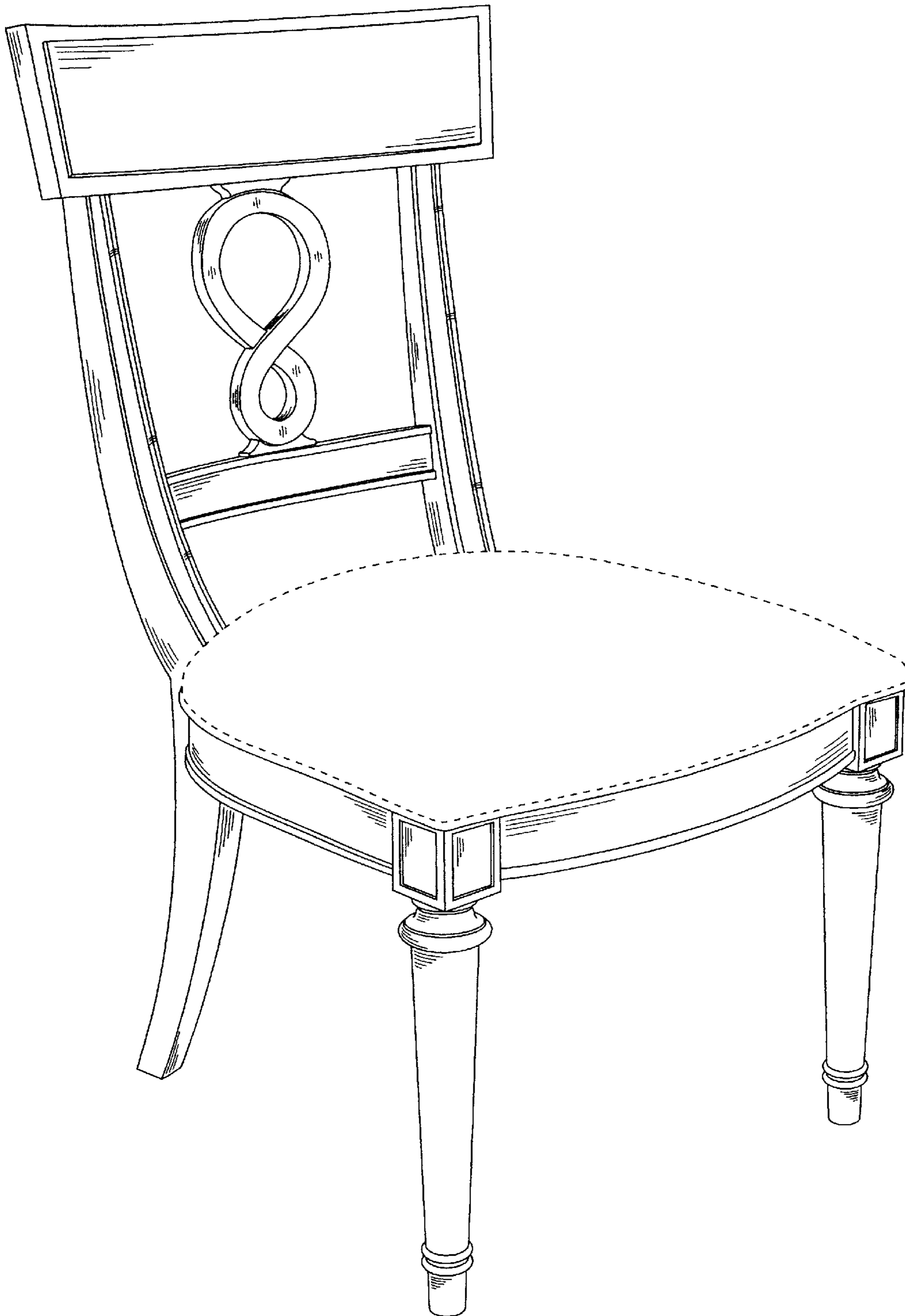

FIG. 6

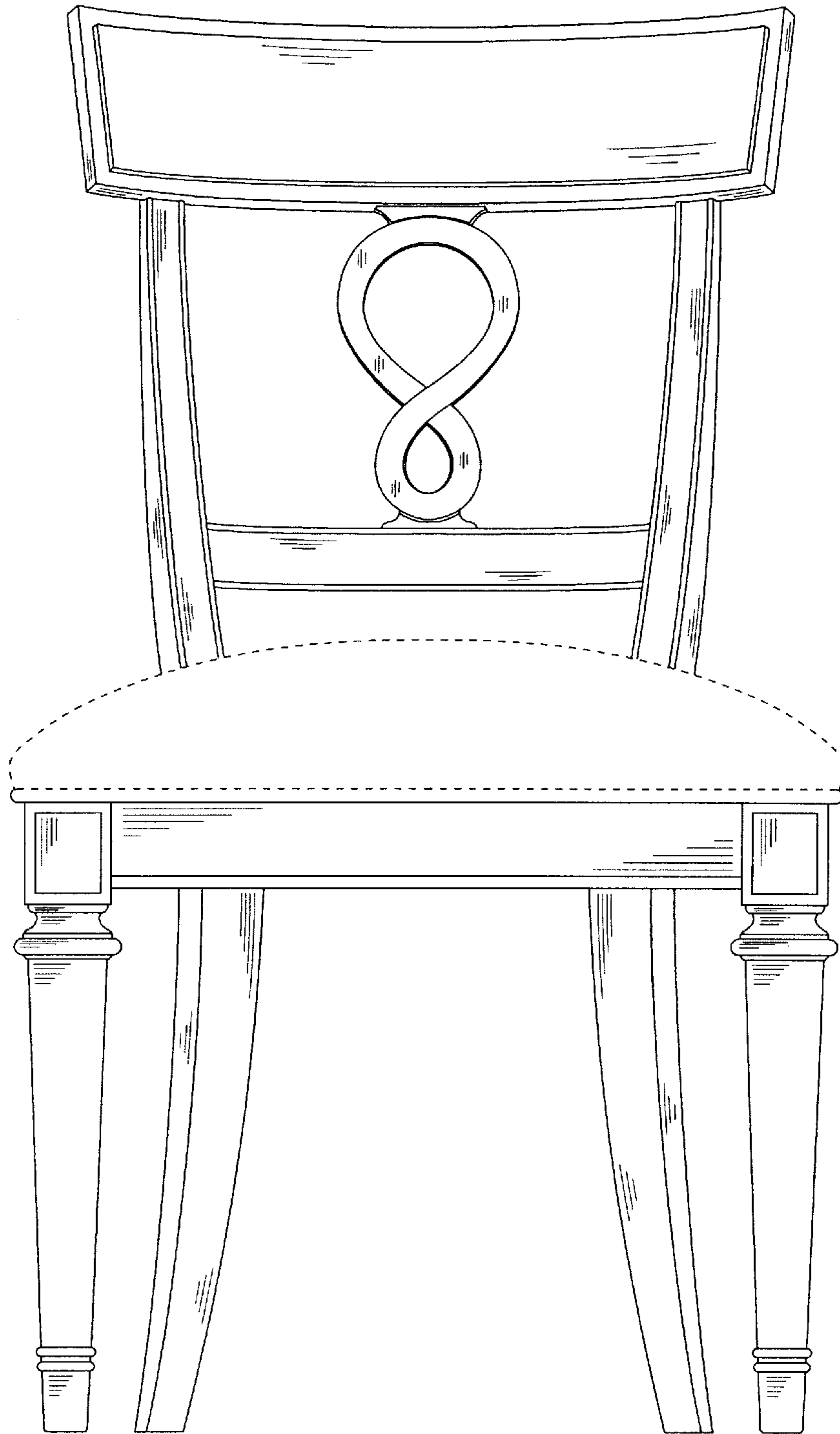

FIG. 7



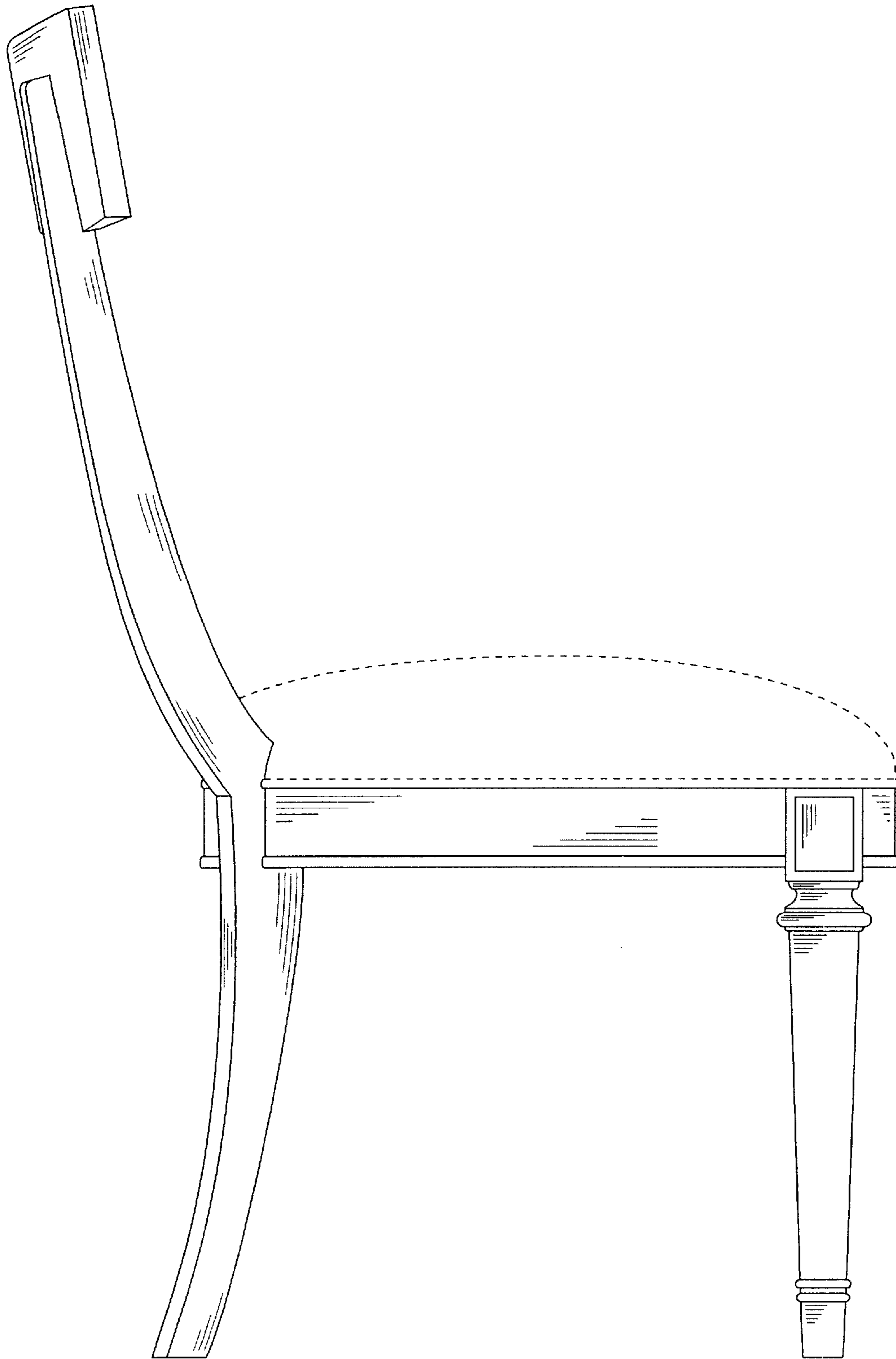

FIG. 8

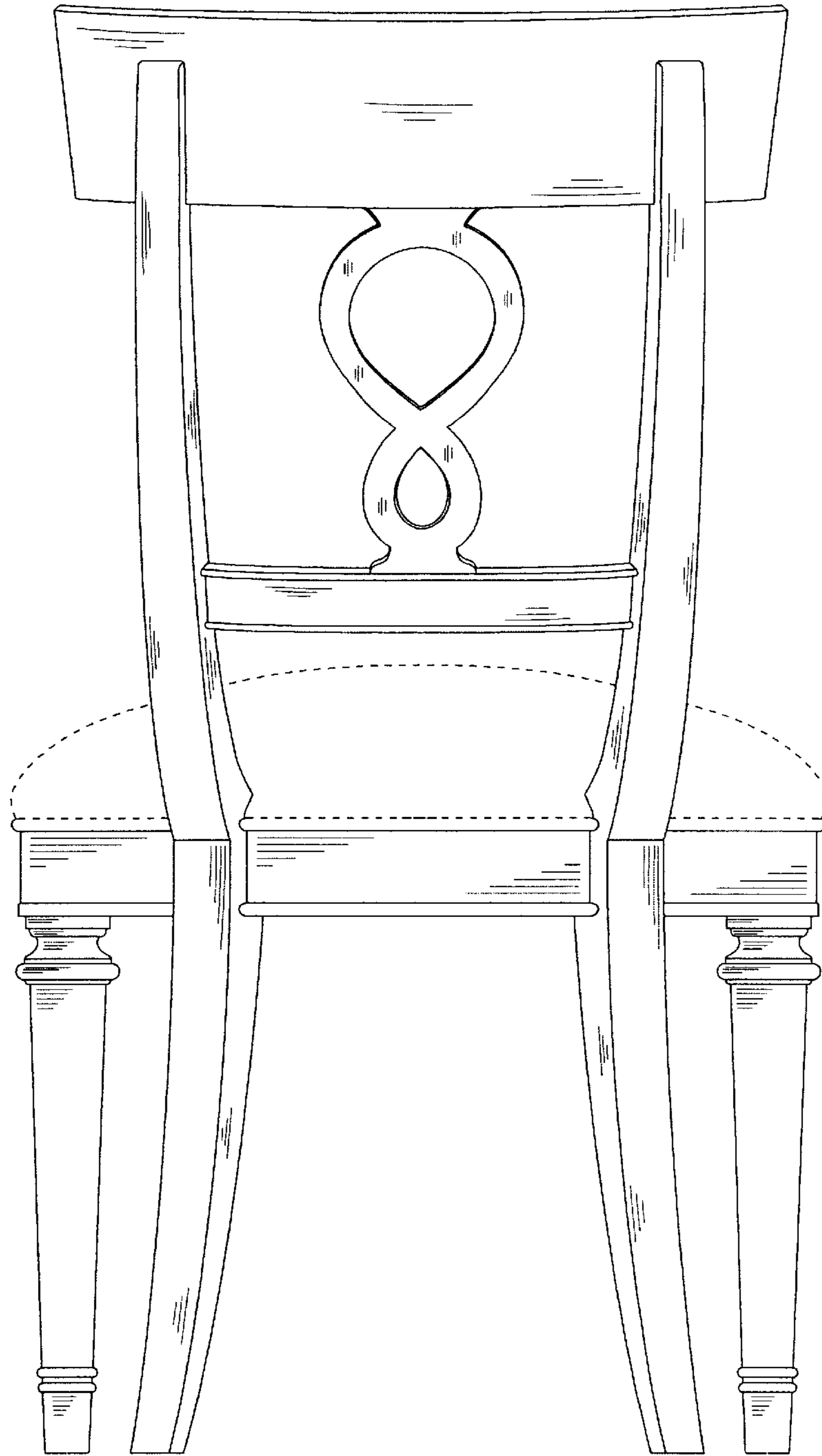

FIG. 9

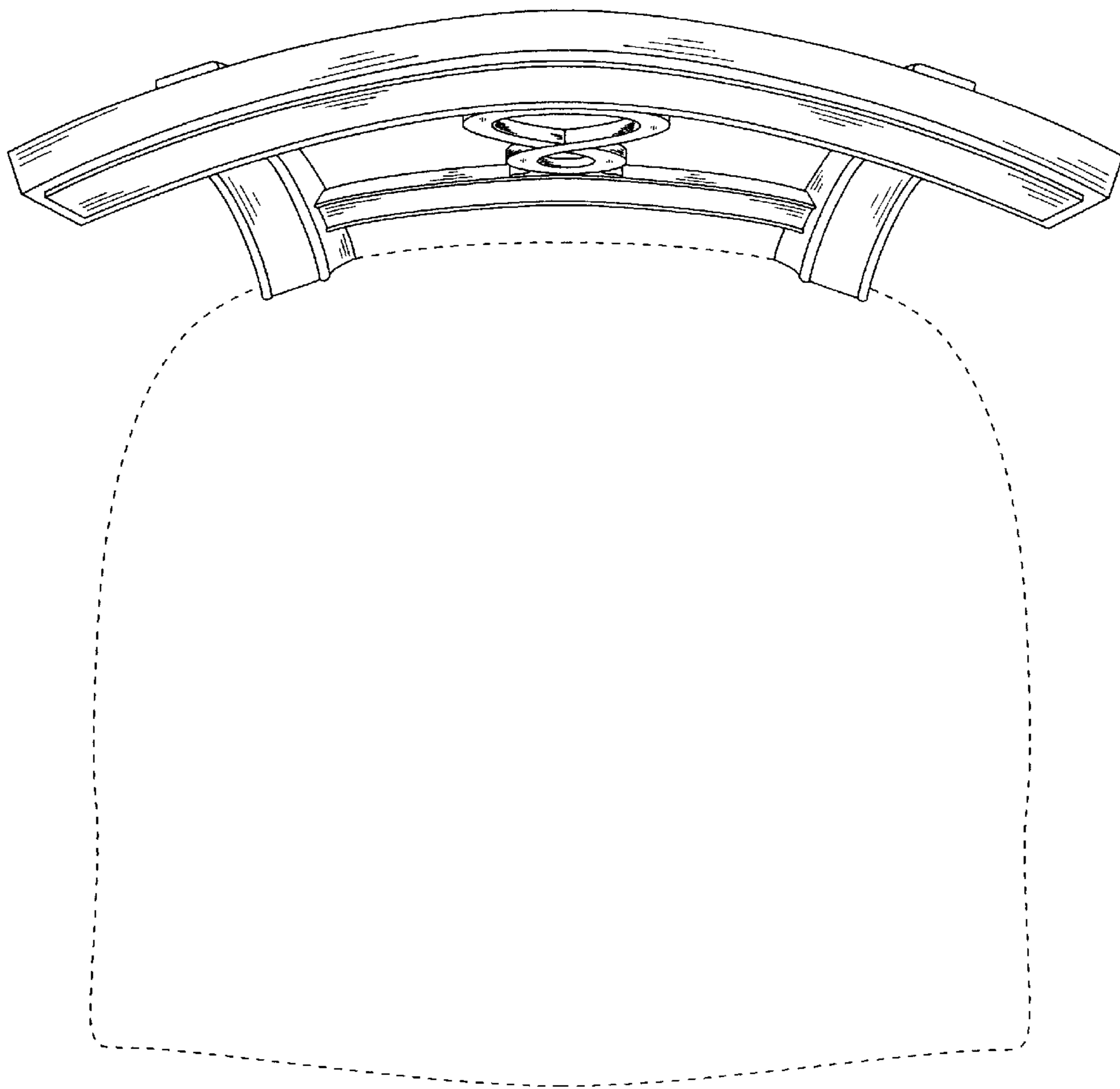

FIG. 10