



US00D526482S

(12) **United States Design Patent**
Esslinger

(10) **Patent No.:** **US D526,482 S**

(45) **Date of Patent:** **** Aug. 15, 2006**

(54) **CASE WITH OPENABLE AND CLOSEABLE INTEGRATED DOCUMENT POUCH**

(75) **Inventor:** **Hartmut Esslinger**, Los Gatos, CA (US)

(73) **Assignee:** **Mobilly International N.V.**, Curacao (NL)

(**) **Term:** **14 Years**

(21) **Appl. No.:** **29/201,487**

(22) **Filed:** **Mar. 17, 2004**

(30) **Foreign Application Priority Data**

Sep. 17, 2003 (EM) 000079033-0002
Sep. 17, 2003 (EM) 000079033-0003
Sep. 17, 2003 (EM) 000079033-0001

(51) **LOC (8) Cl.** **03-01**

(52) **U.S. Cl.** **D3/279**

(58) **Field of Classification Search** D3/276,
D3/279, 283, 284; 190/18 A, 109, 110, 111,
190/112

See application file for complete search history.

(56) **References Cited**

U.S. PATENT DOCUMENTS

D336,365 S * 6/1993 Huang D3/279
D357,354 S * 4/1995 Marchwiak et al. D3/279

D431,906 S * 10/2000 Livingston D3/279
D455,262 S * 4/2002 Krulik D3/279
D463,910 S * 10/2002 Tchan D3/279
D474,598 S * 5/2003 Platte, III D3/279
D481,204 S * 10/2003 Rada D3/279
D489,528 S * 5/2004 Ihenacho et al. D3/279
D491,359 S * 6/2004 Oh D3/279

* cited by examiner

Primary Examiner—Philip S. Hyder

(74) *Attorney, Agent, or Firm*—Diller, Ramik & Wight

(57) **CLAIM**

The ornamental design for a case with openable and closeable integrated document pouch, as shown and described.

DESCRIPTION

FIG. 1 is a side elevational view of a case with openable and closeable integrated document pouch, the opposite side being substantially identical thereto, in its closed condition with integrated document pouches showing my new design.

FIG. 2 is an end elevational view, the opposite end being substantially identical thereto;

FIG. 3 is a side elevational view of the case of FIG. 4 in its open condition;

FIG. 4 is an end elevational view of the case of FIG. 3;

FIG. 5 is a bottom plan view of FIG. 4; and,

FIG. 6 is a top plan view of FIG. 4.

1 Claim, 6 Drawing Sheets

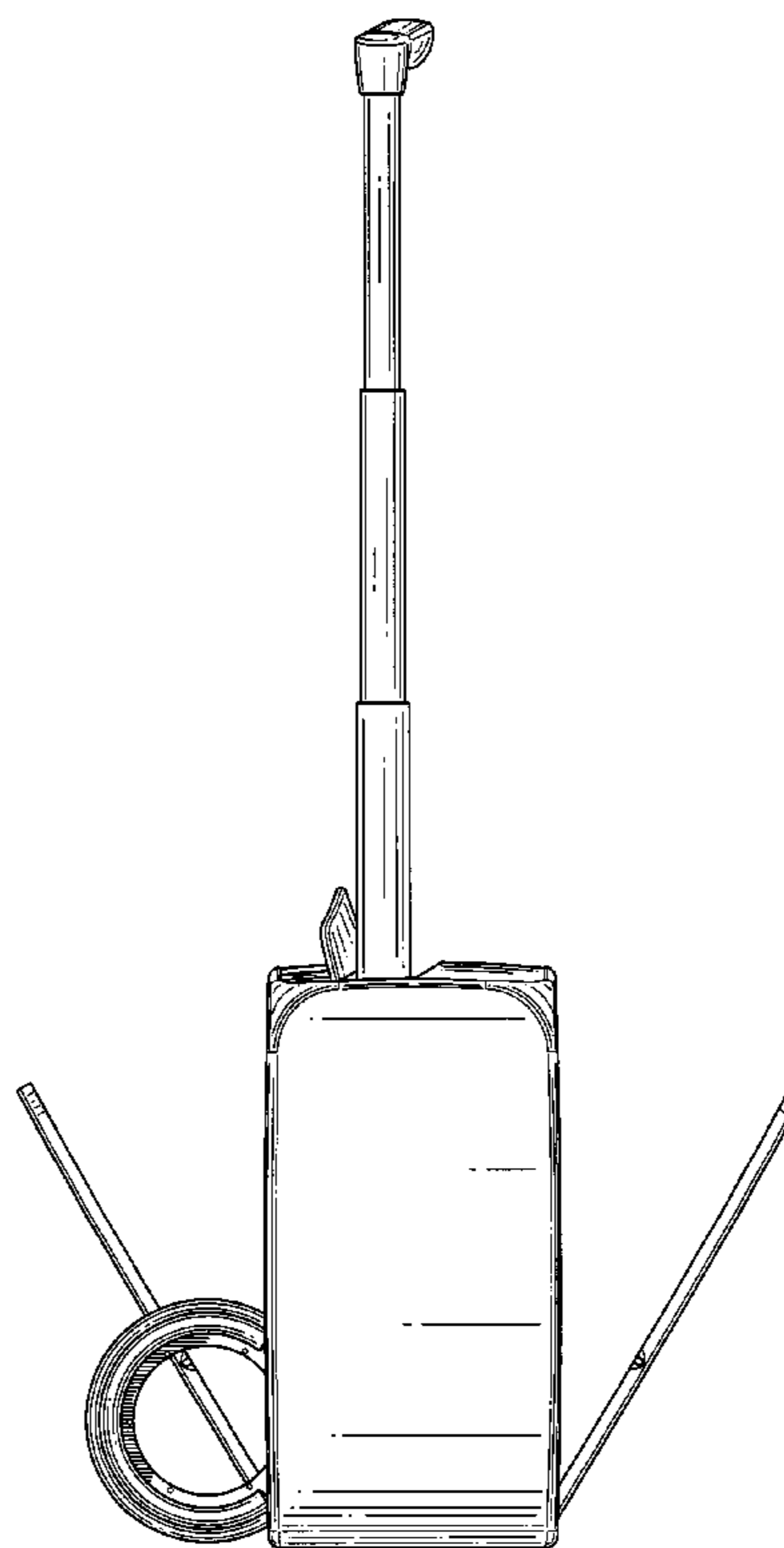
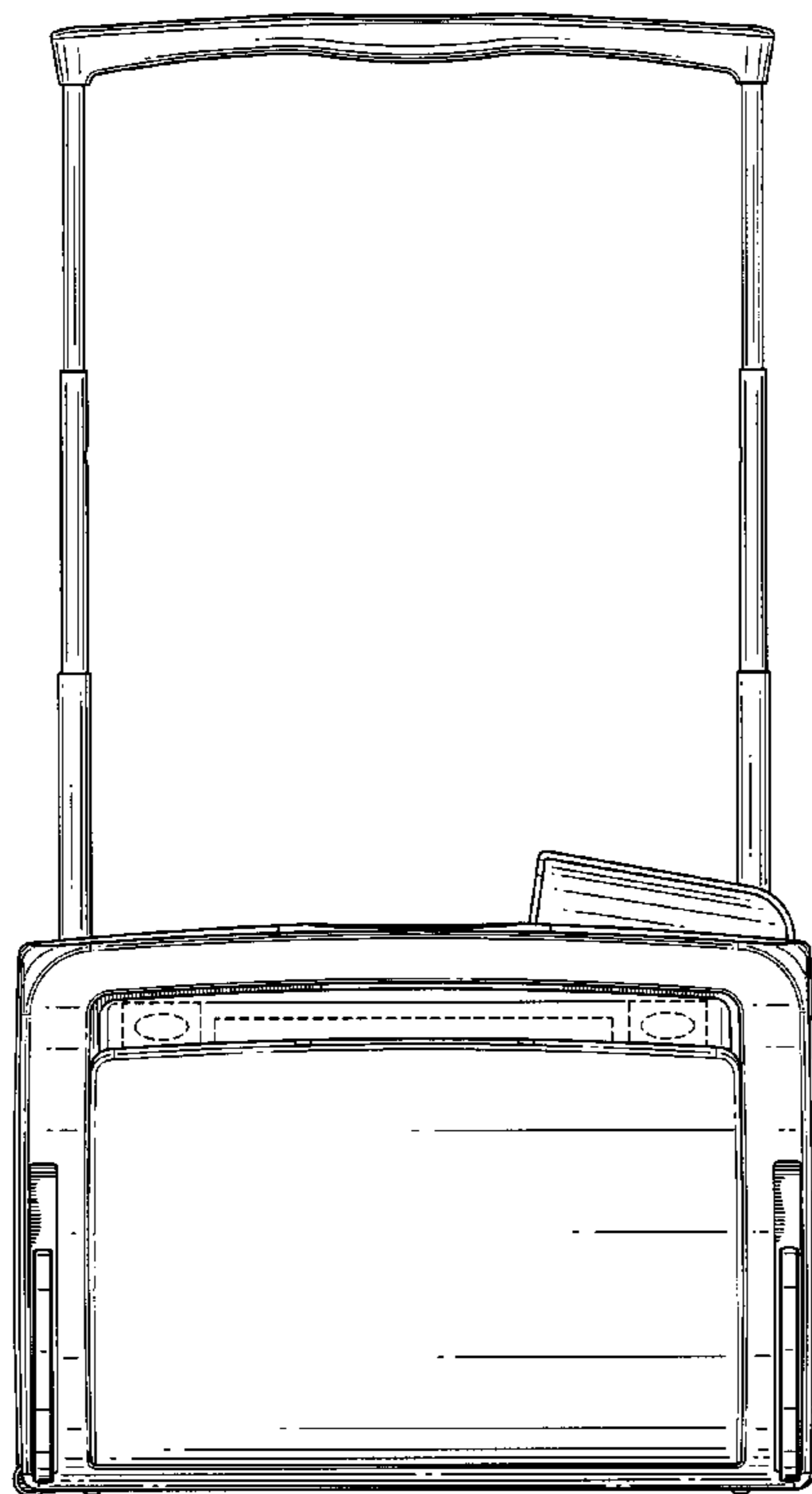



FIG. 1

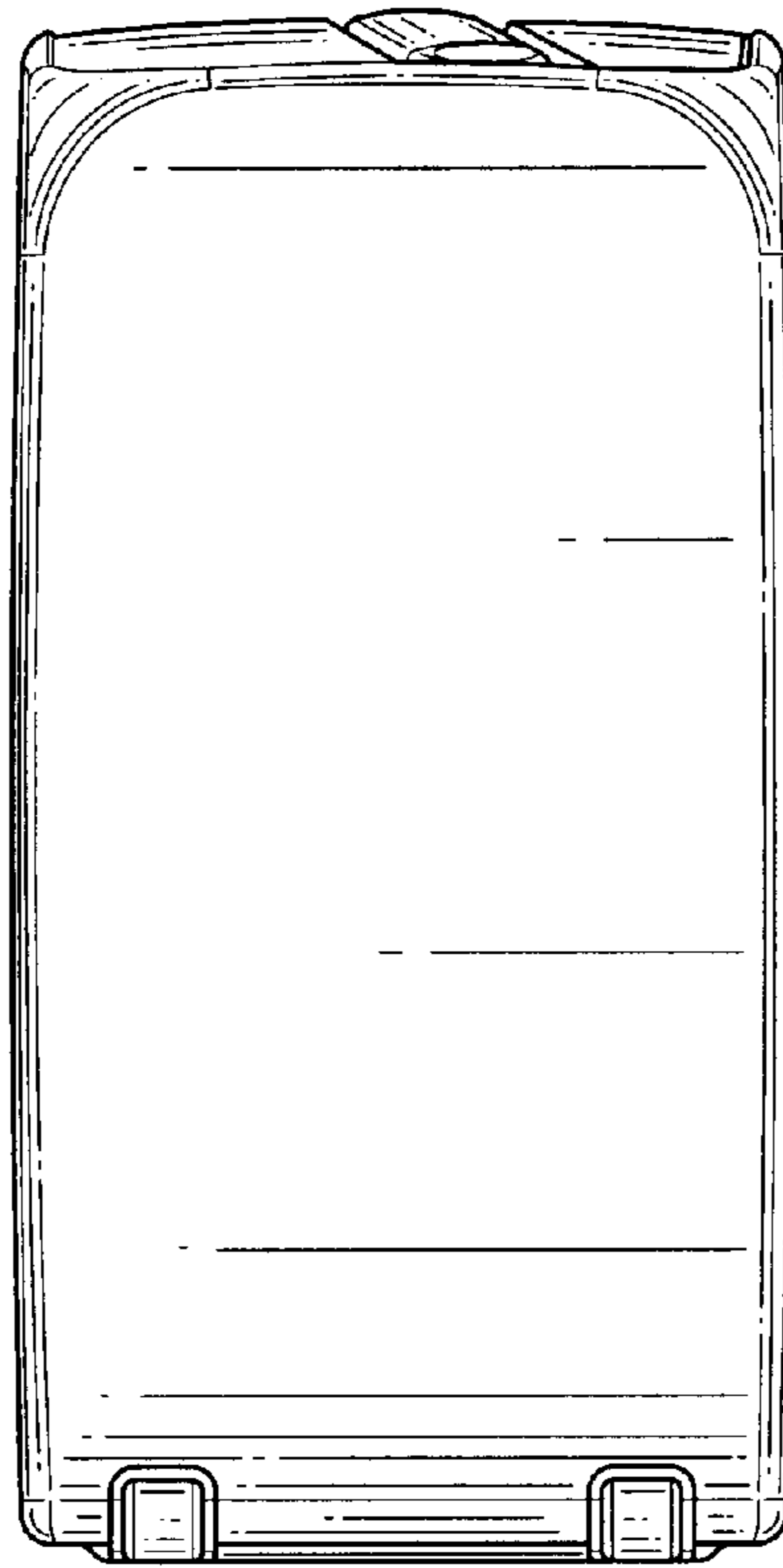
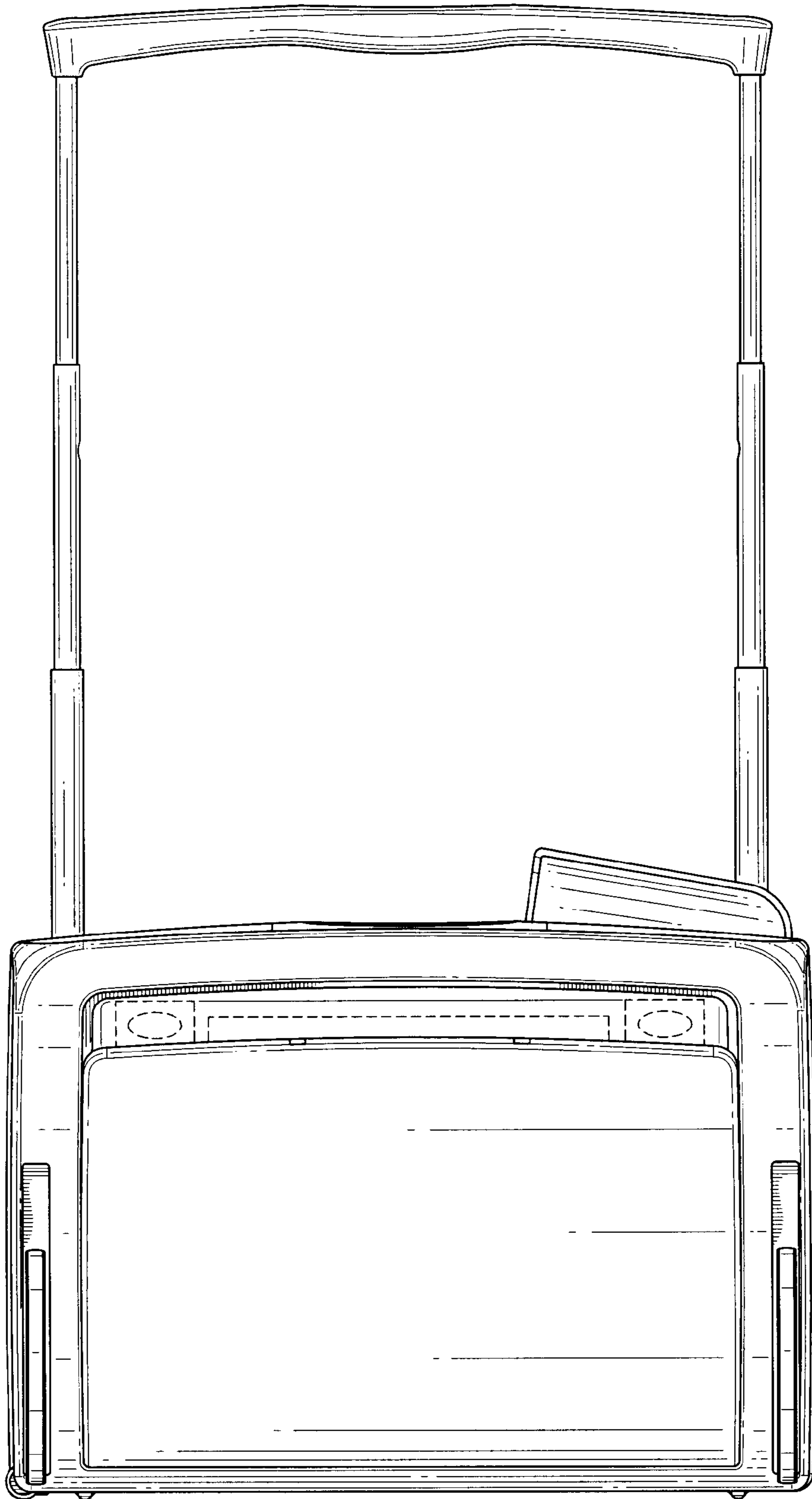

FIG. 2

FIG. 3



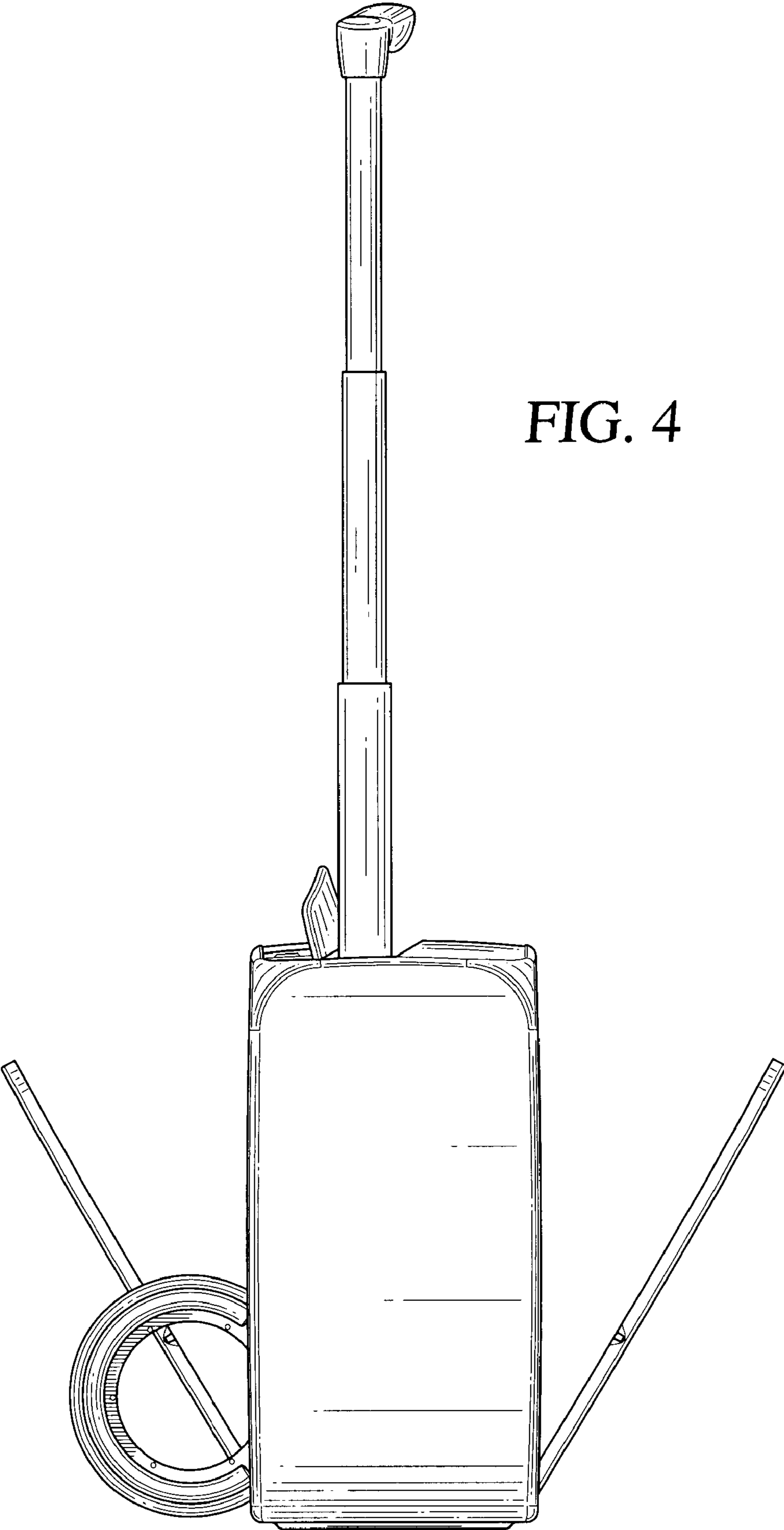

FIG. 4

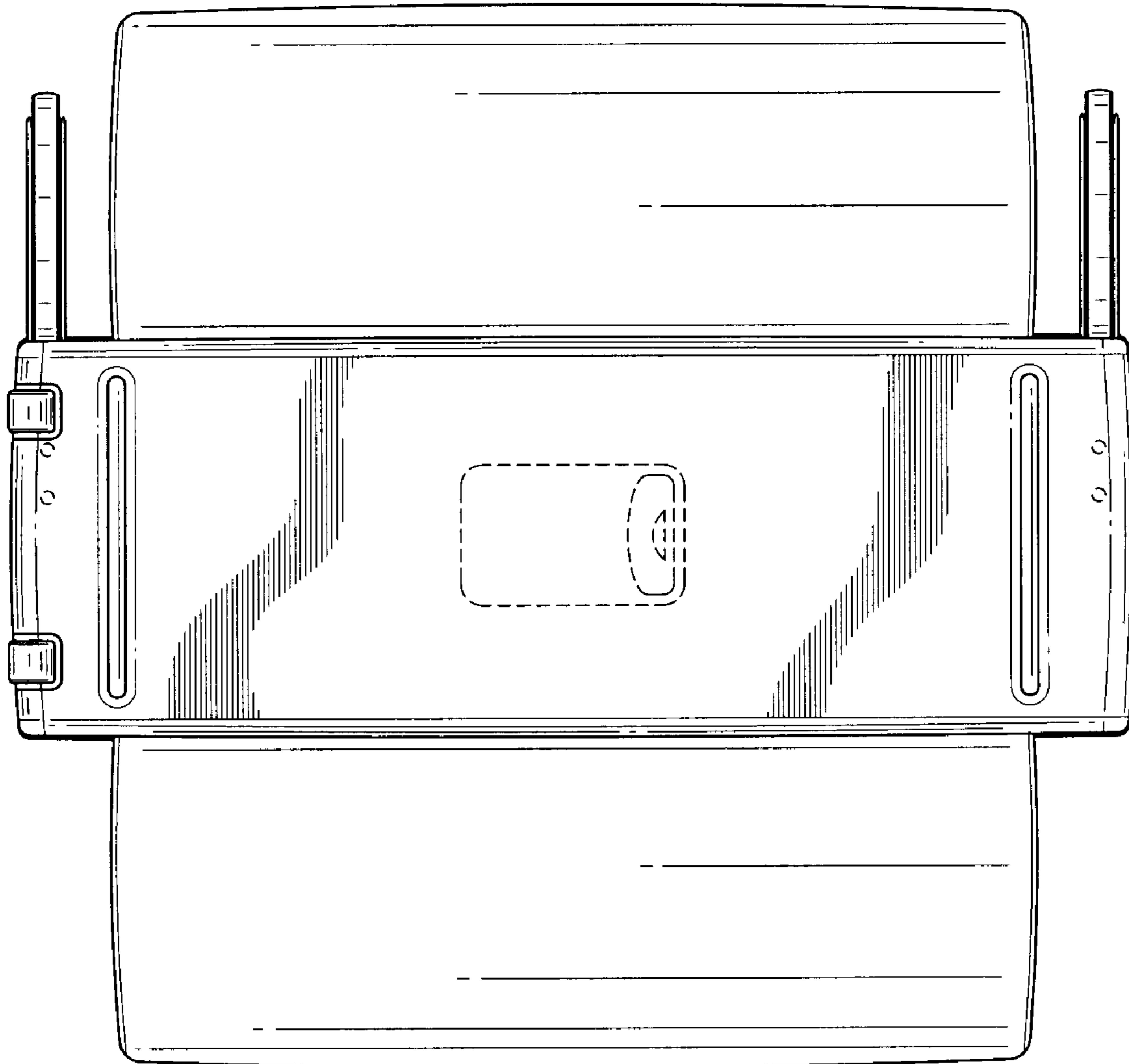

FIG. 5

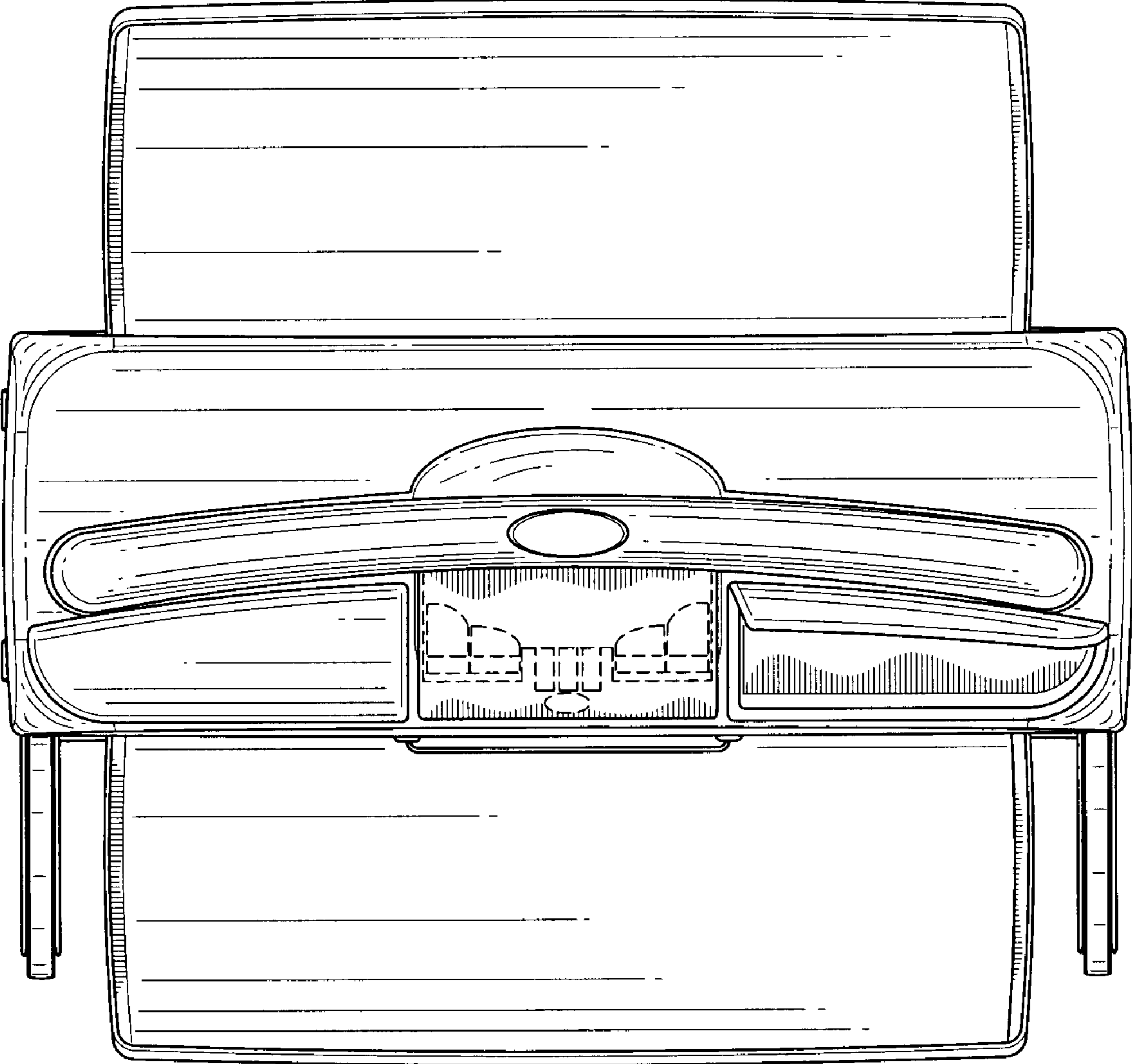

FIG. 6