



US00D526417S

(12) **United States Design Patent**
Masuda

(10) **Patent No.:** **US D526,417 S**

(45) **Date of Patent:** **** Aug. 8, 2006**

(54) **COMBINED COSMETIC DEVICE AND VIBRATOR**

(76) Inventor: **Masatoshi Masuda**, 2, 9-banchi, Takada-Cho, Saiin, Ukyo-ku, Kyoto City, Kyoto 615-0031 (JP)

(**) Term: **14 Years**

(21) Appl. No.: **29/215,266**

(22) Filed: **Oct. 15, 2004**

(51) **LOC (8) Cl.** **28-03**

(52) **U.S. Cl.** **D24/214**

(58) **Field of Classification Search** D24/200, D24/214, 215, 107, 108, 146, 147; D28/9; 606/131; 601/6, 93, 15, 78, 94; 604/315

See application file for complete search history.

(56) **References Cited**

U.S. PATENT DOCUMENTS

3,906,940	A	*	9/1975	Kawada	601/6
D298,775	S	*	11/1988	Lee	D24/214
D323,034	S	*	1/1992	Reinstein	D24/206
D329,291	S	*	9/1992	Wollman	D24/214
D407,498	S	*	3/1999	Cooper	D24/215
D414,582	S	*	9/1999	Hwang	D24/214

D425,241	S	*	5/2000	Nishizawa et al.	D28/9
D430,938	S	*	9/2000	Lee	D24/215
D448,852	S	*	10/2001	Engelen	D24/215
6,652,888	B1	*	11/2003	Rhoades	601/46
6,730,050	B1	*	5/2004	Huang	601/94
D510,158	S	*	9/2005	Cheung	D24/147

* cited by examiner

Primary Examiner—Ian Simmons

Assistant Examiner—Melanie Levy

(74) *Attorney, Agent, or Firm*—Knobbe, Martens Olson & Bear LLP

(57) **CLAIM**

I claim the ornamental design for a combined cosmetic device and vibrator, as shown and described.

DESCRIPTION

FIG. 1 is a front view of a combined cosmetic device and vibrator as shown and described;

FIG. 2 is a rear view thereof;

FIG. 3 is a left side view thereof;

FIG. 4 is a right side view thereof;

FIG. 5 is a top plan view thereof; and,

FIG. 6 is a bottom plan view thereof.

1 Claim, 6 Drawing Sheets

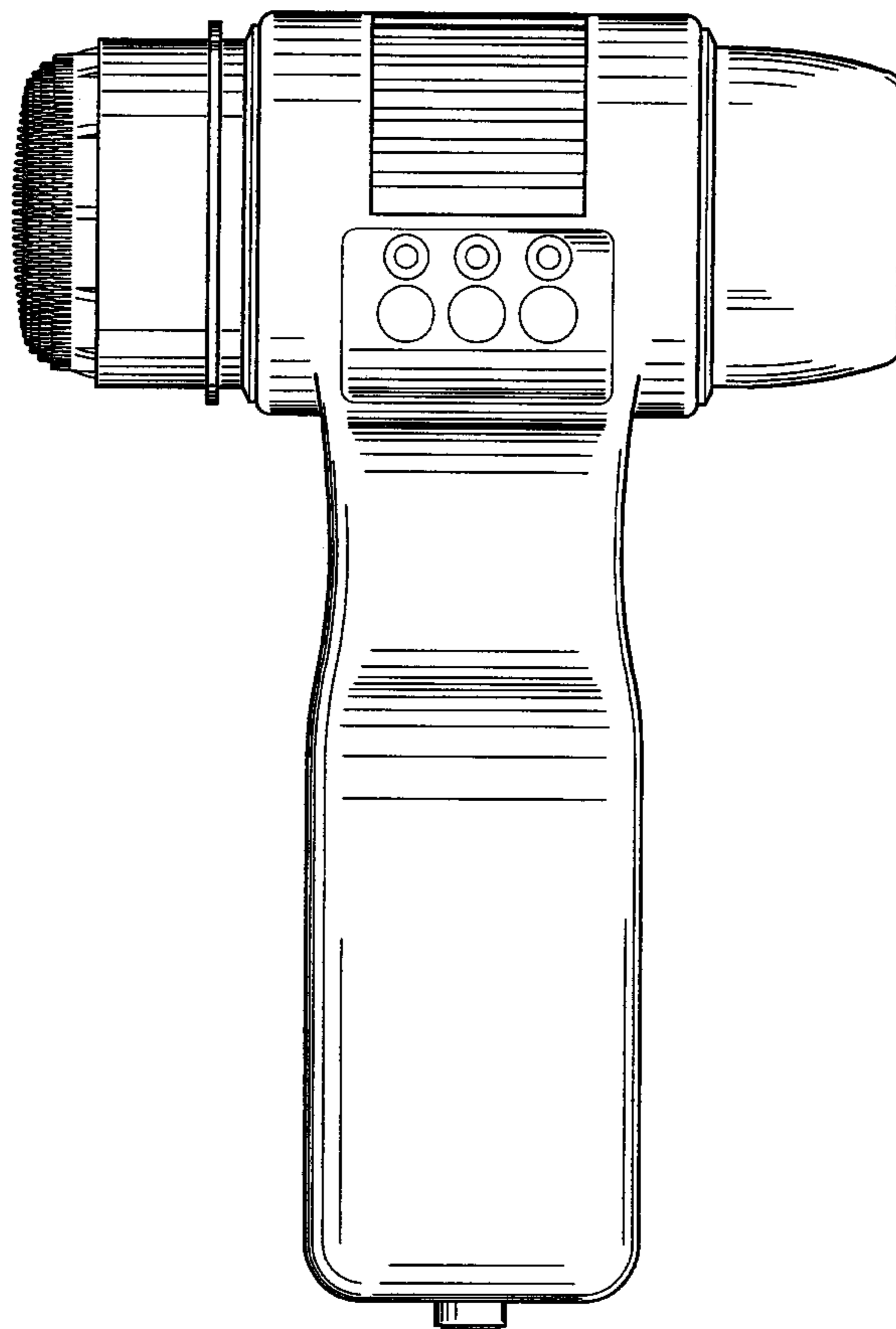

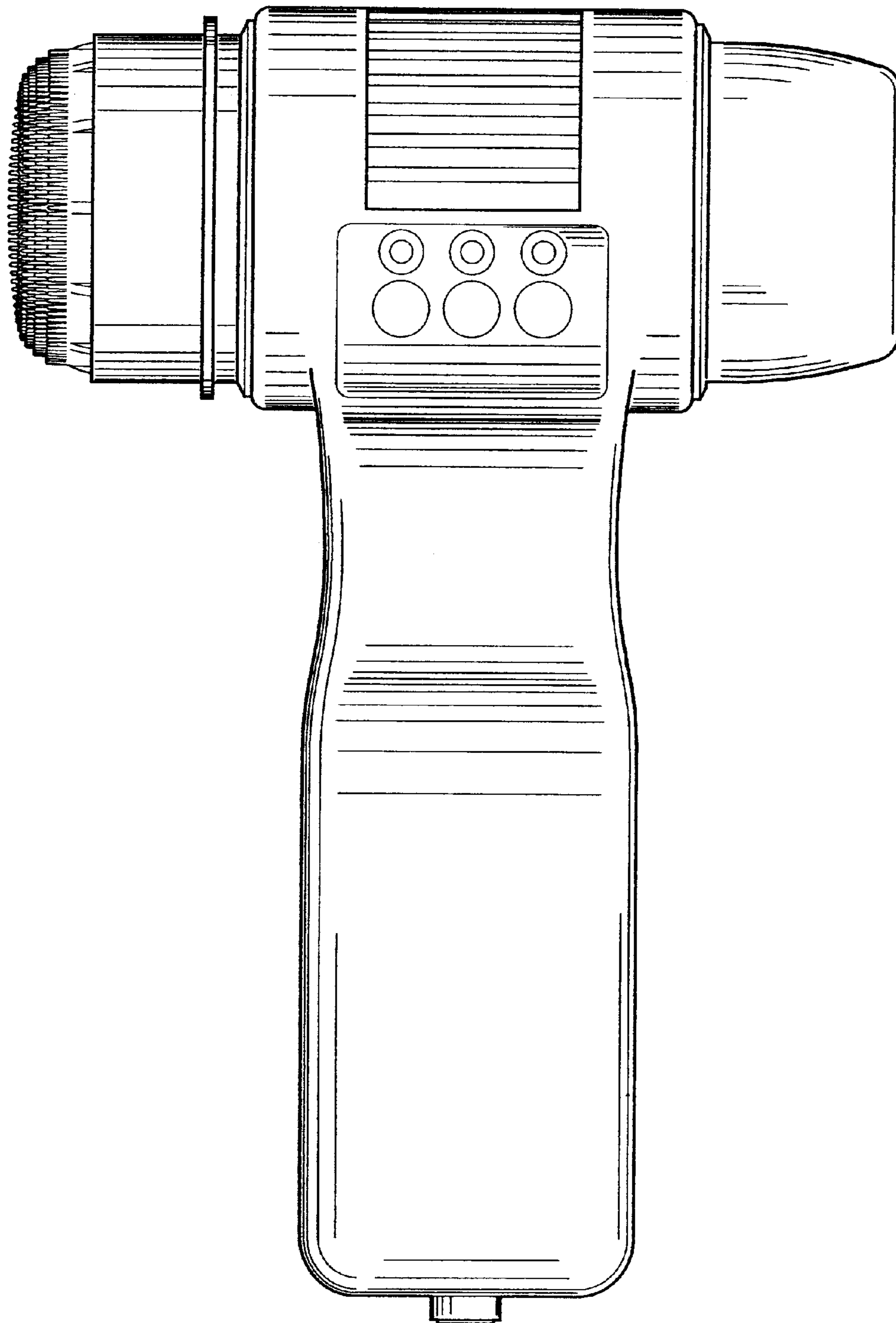

Fig. 1

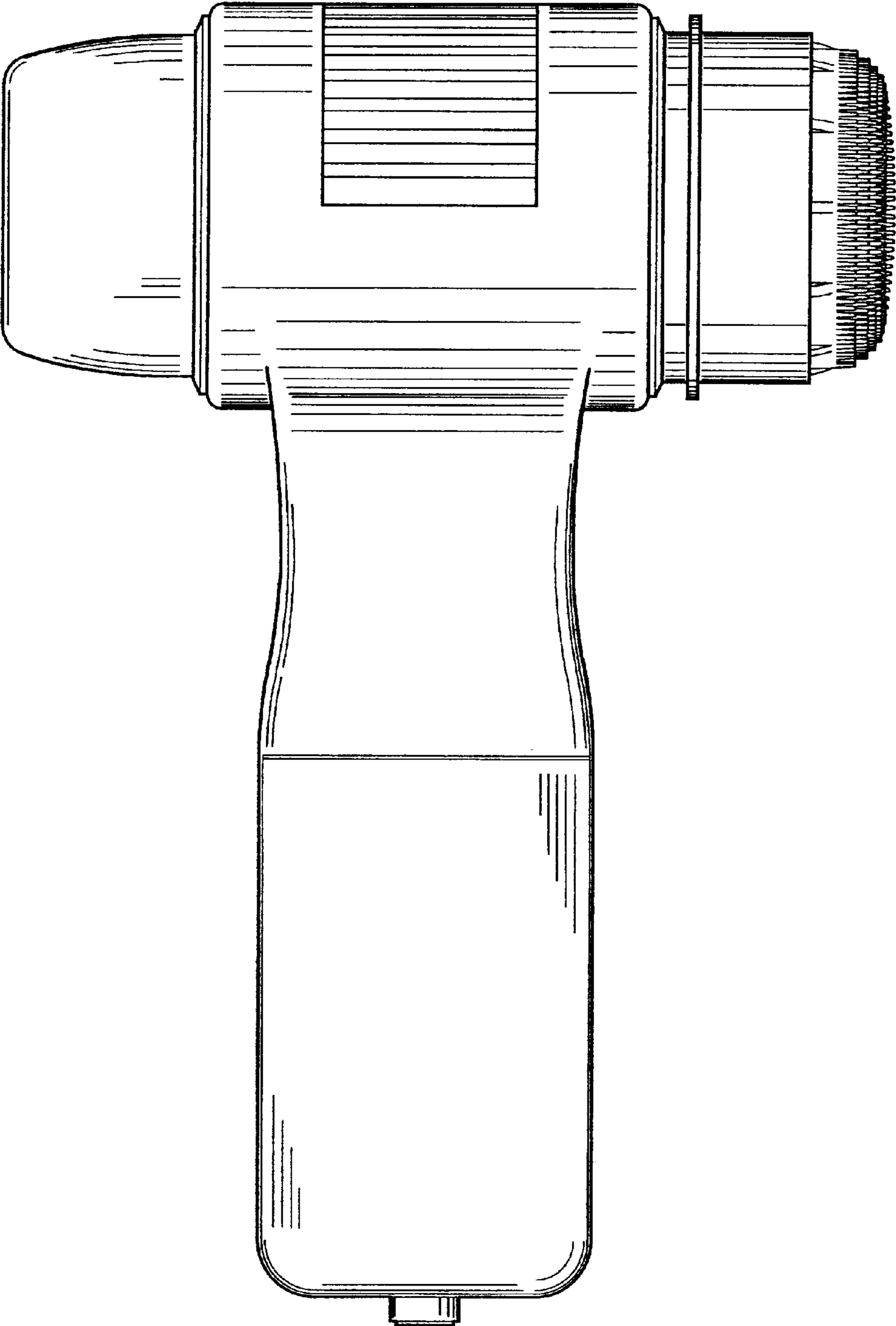

Fig.2

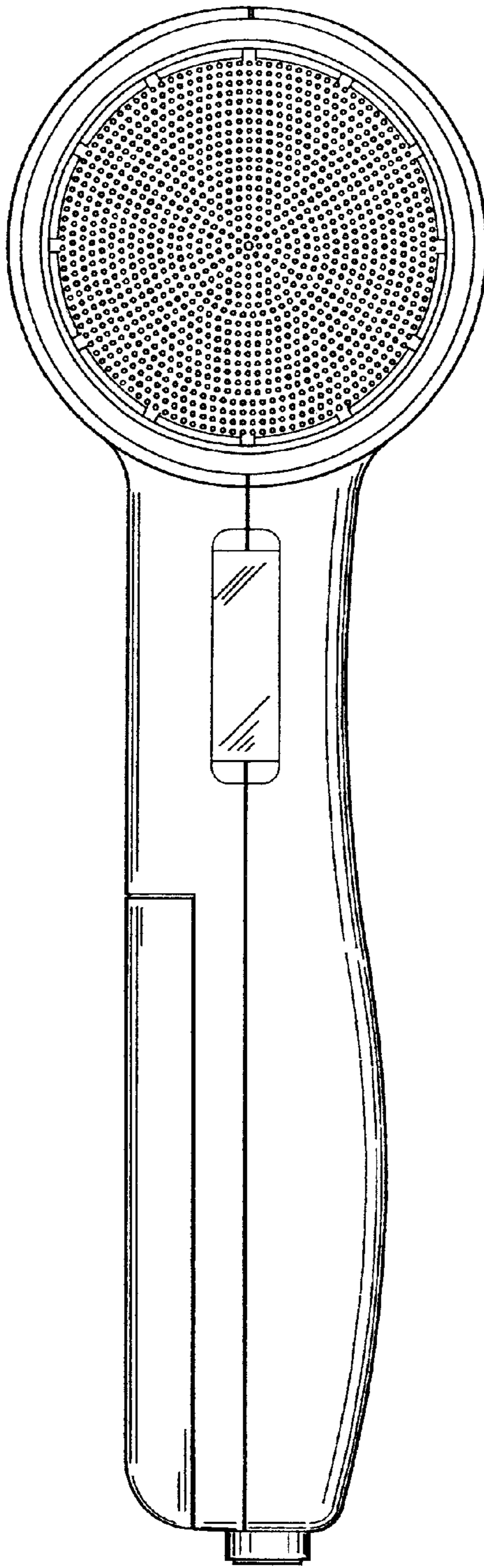

Fig.3

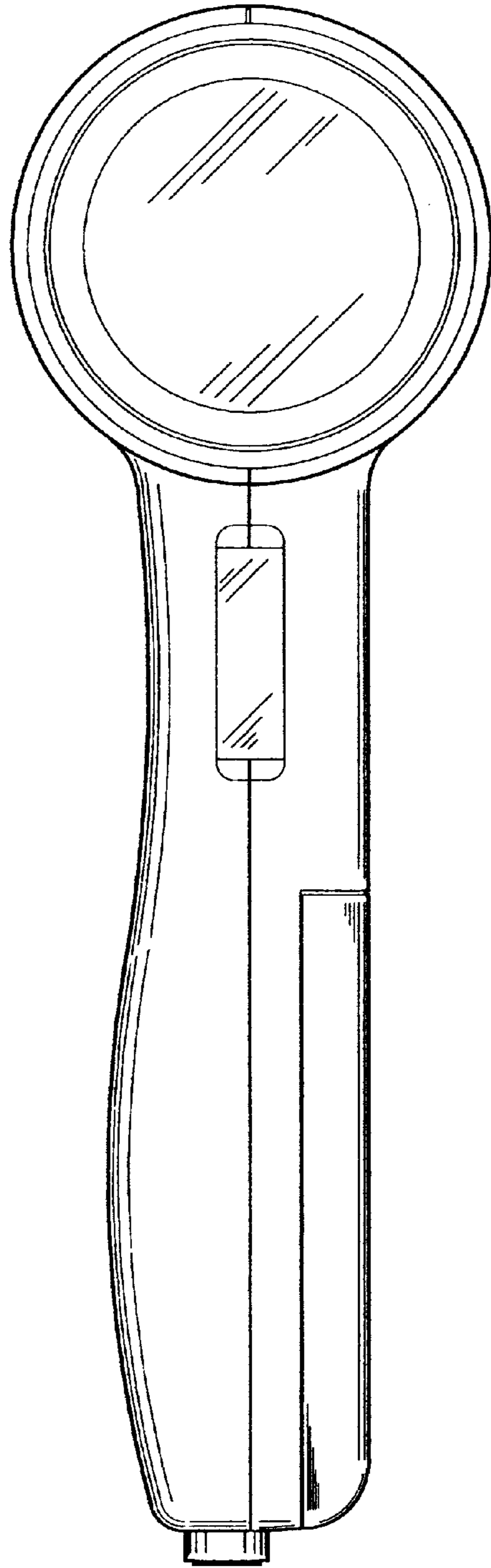

Fig. 4

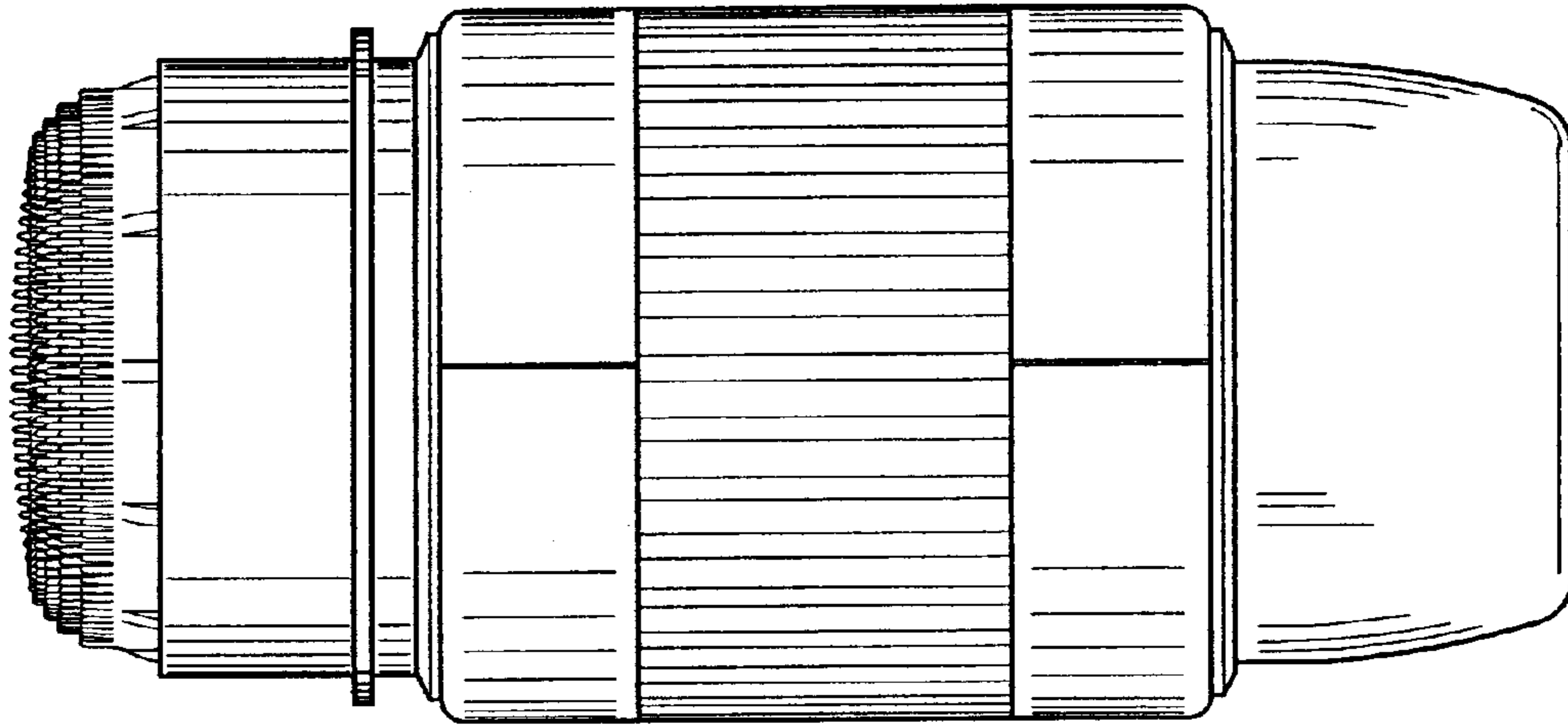

Fig.5

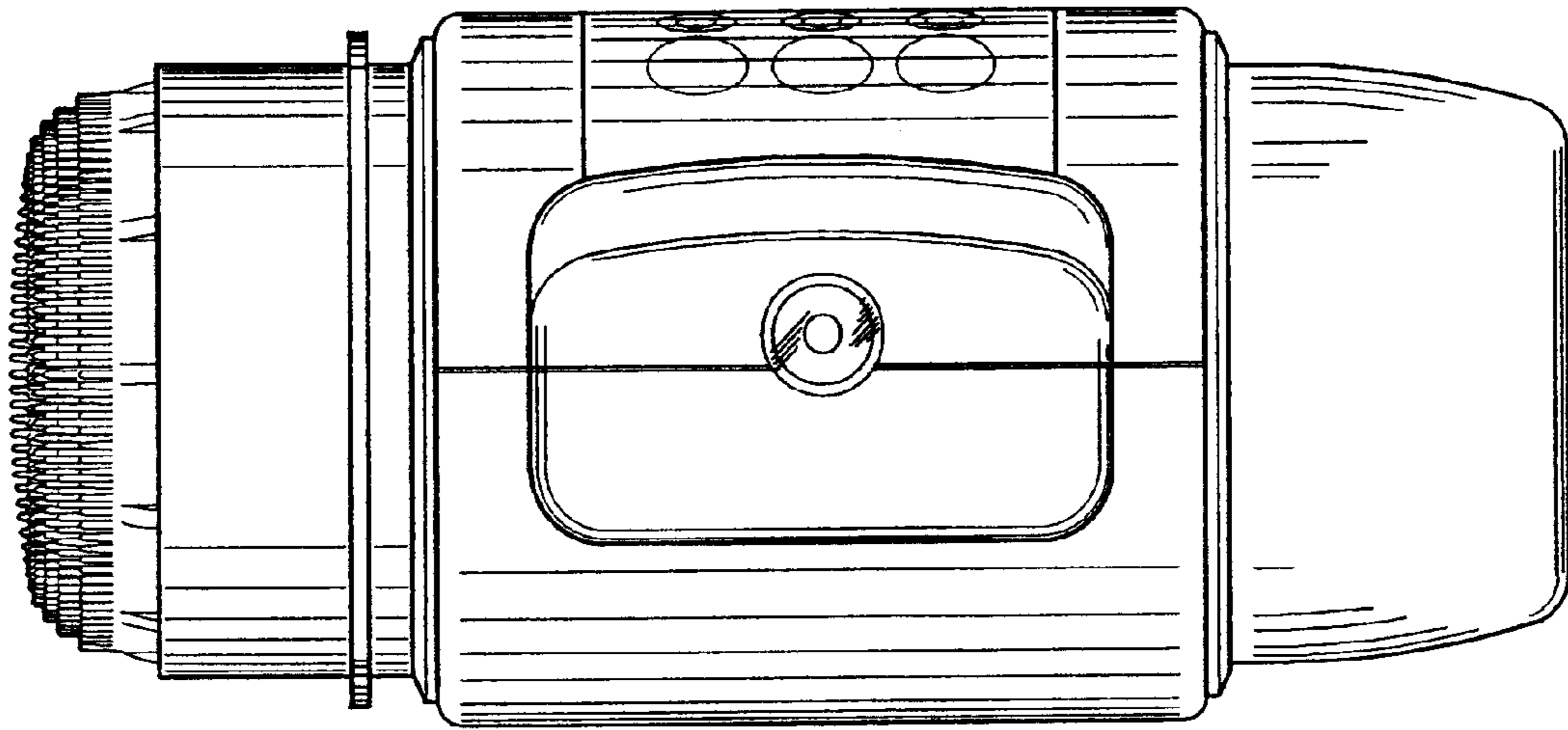

Fig.6