

US00D526412S

(12) **United States Design Patent** (10) **Patent No.:** **US D526,412 S**
Harn et al. (45) **Date of Patent:** **** Aug. 8, 2006**

(54) **ARTIFICIAL JOINT**

(75) Inventors: **Chuen-Sen Harn**, Xin-Zhuang (TW);
Rueng-Jie Zhen, Xin-Zhuang (TW)

(73) Assignee: **Chang-Yu Mechanical System Ltd.**,
Taipei (TW)

(**) Term: **14 Years**

(21) Appl. No.: **29/231,508**

(22) Filed: **Jun. 7, 2005**

(51) **LOC (8) Cl.** **24-03**

(52) **U.S. Cl.** **D24/155**

(58) **Field of Classification Search** D24/155;
606/61, 72, 74; 623/17.16, 17.17, 11.11,
623/11, 16, 35, 32, 27, 20, 30, 37, 39, 44,
623/45, 43, 38

See application file for complete search history.

(56) **References Cited**

U.S. PATENT DOCUMENTS

5,545,232	A	*	8/1996	Van de Veen	623/39
D383,542	S	*	9/1997	Wellershaus et al.	D24/155
5,728,173	A	*	3/1998	Chen	623/39
D402,368	S	*	12/1998	Holzapfel	D24/155
6,106,560	A	*	8/2000	Boender	623/44
6,117,177	A	*	9/2000	Chen et al.	623/44
D439,339	S	*	3/2001	Sawatzki	D24/155

D446,304	S	*	8/2001	Sawatzki et al.	D24/155
6,322,594	B1	*	11/2001	Boiten et al.	623/27
6,558,430	B1	*	5/2003	Nakaya et al.	623/17.16
6,743,255	B1	*	6/2004	Ferree	623/17.11
2002/0045946	A1	*	4/2002	Habecker	623/17.11
2004/0059433	A1	*	3/2004	Slemker et al.	623/17.16
2005/0038523	A1	*	2/2005	Cheng	623/17.16
2005/0149203	A1	*	7/2005	Andrysek et al.	623/17.11
2005/0154473	A1	*	7/2005	Bassett	623/17.16
2005/0203639	A1	*	9/2005	Wild	623/17.16
2005/0234562	A1	*	10/2005	Okuda et al.	623/17.16

* cited by examiner

Primary Examiner—Charles A. Rademaker

(74) *Attorney, Agent, or Firm*—Rabin & Berdo, P.C.

(57) **CLAIM**

The ornamental design for artificial joint, as shown and described.

DESCRIPTION

FIG. 1 is a perspective view of artificial joint showing my new design;

FIG. 2 is a front elevational view thereof;

FIG. 3 is a rear elevational view thereof;

FIG. 4 is a left elevational view thereof;

FIG. 5 is a right elevational view thereof;

FIG. 6 is a top view thereof; and,

FIG. 7 is a bottom view.

1 Claim, 7 Drawing Sheets

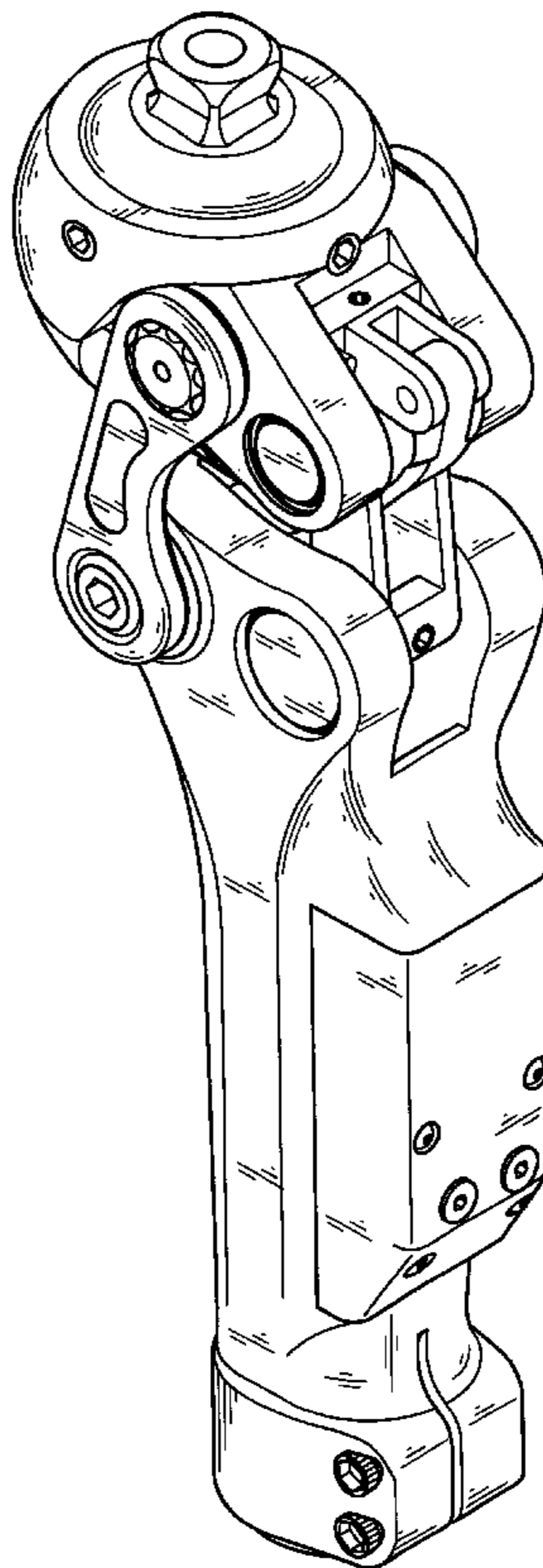

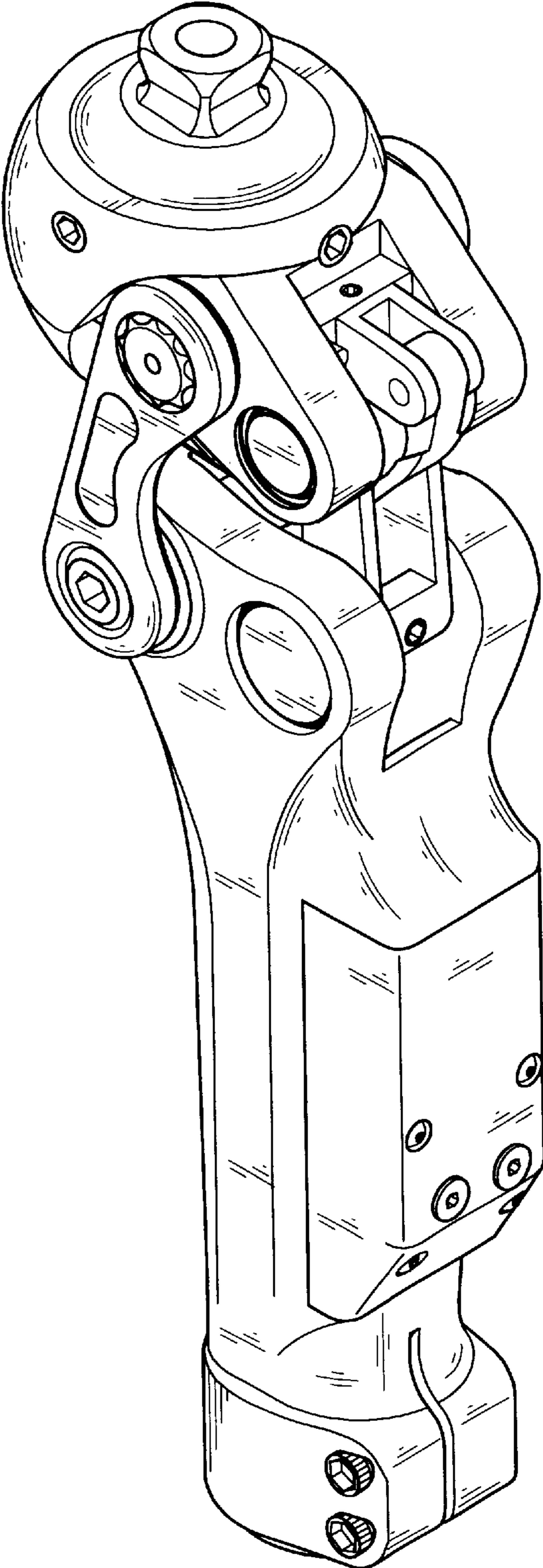

FIG. 1

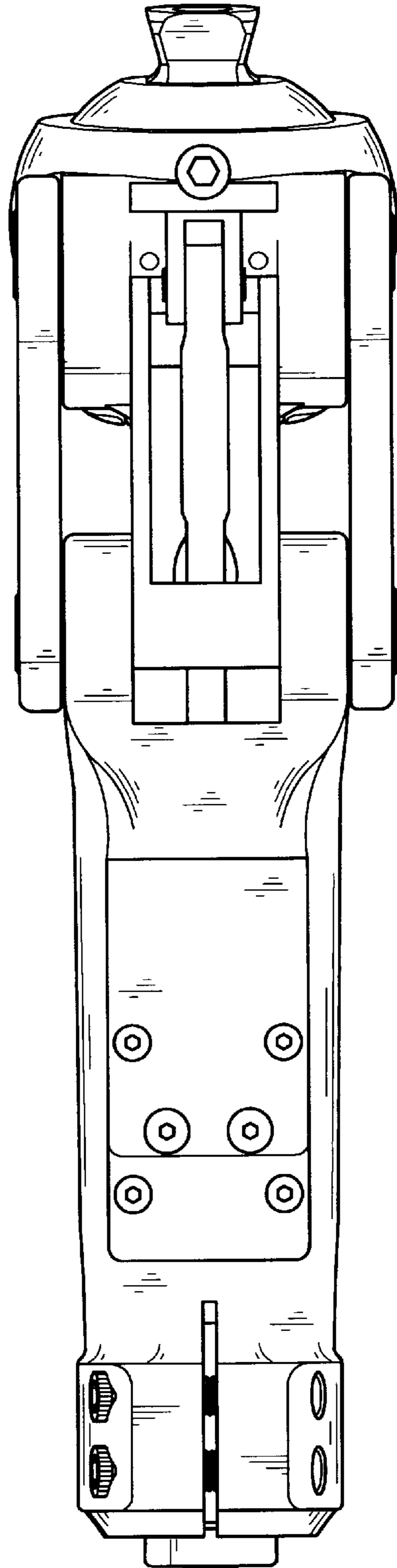

FIG. 2

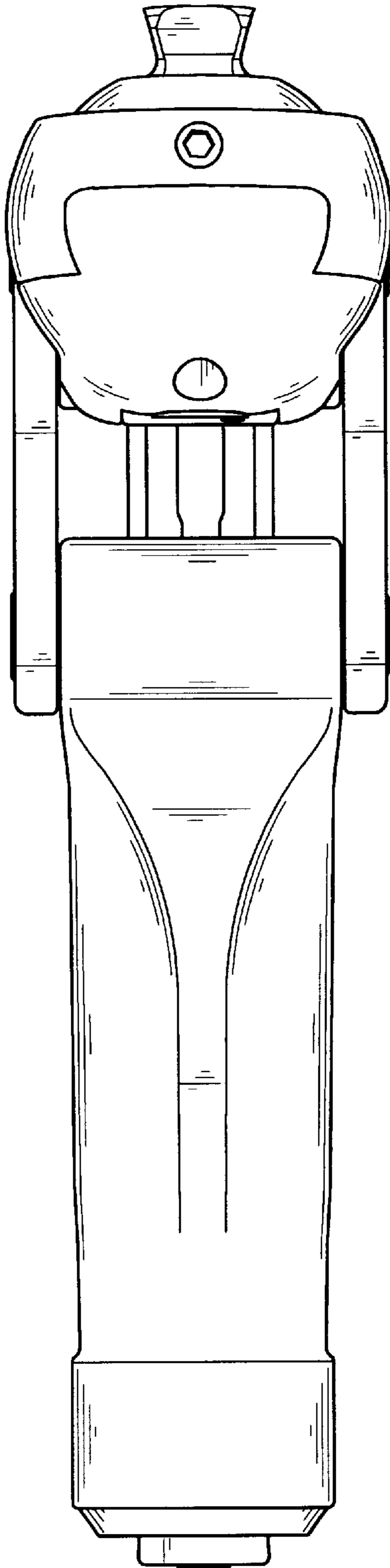

FIG. 3

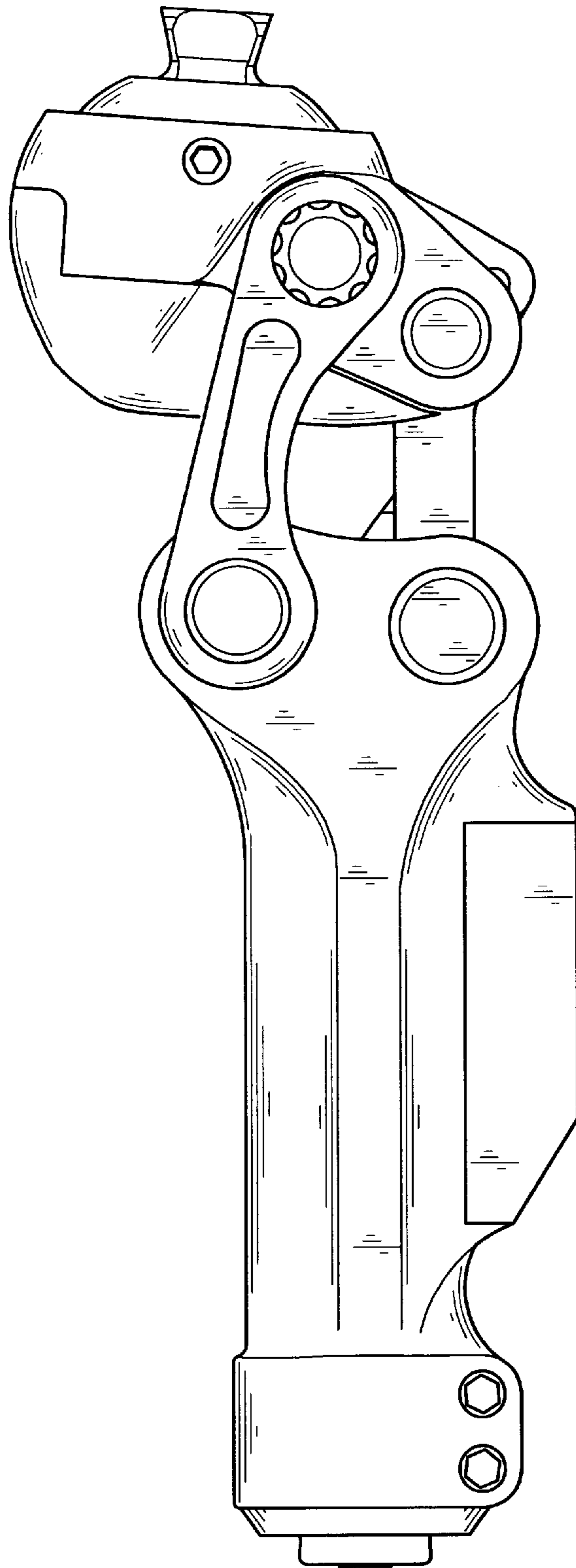

FIG. 4

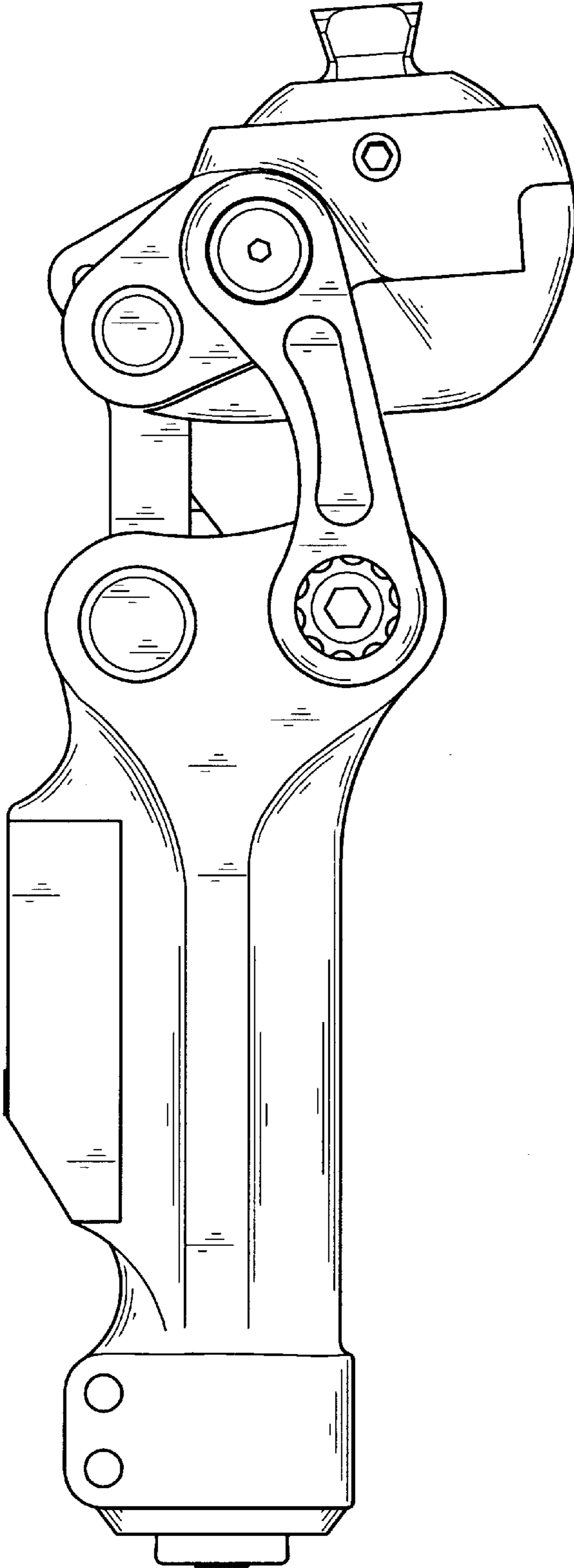

FIG. 5

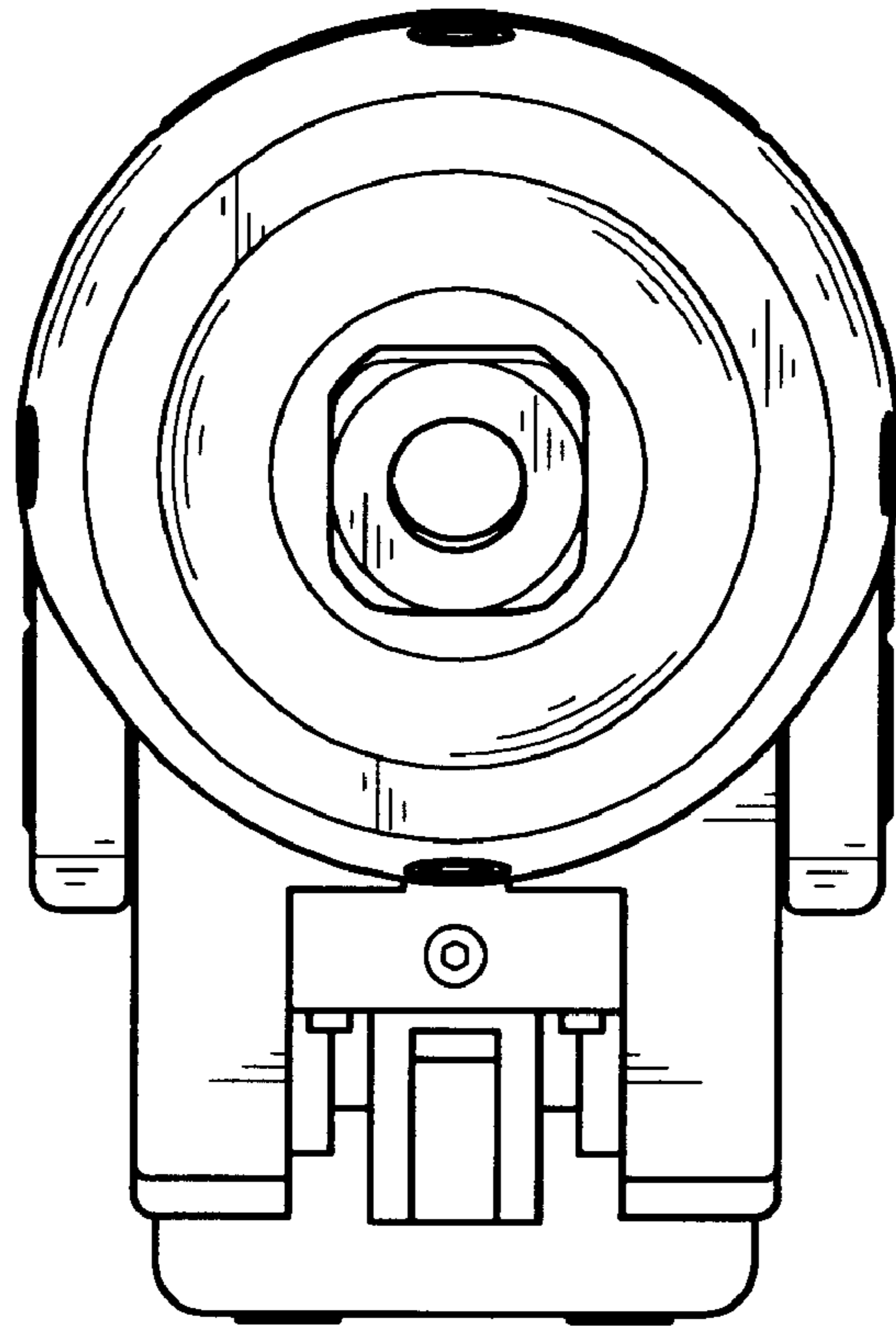

FIG. 6

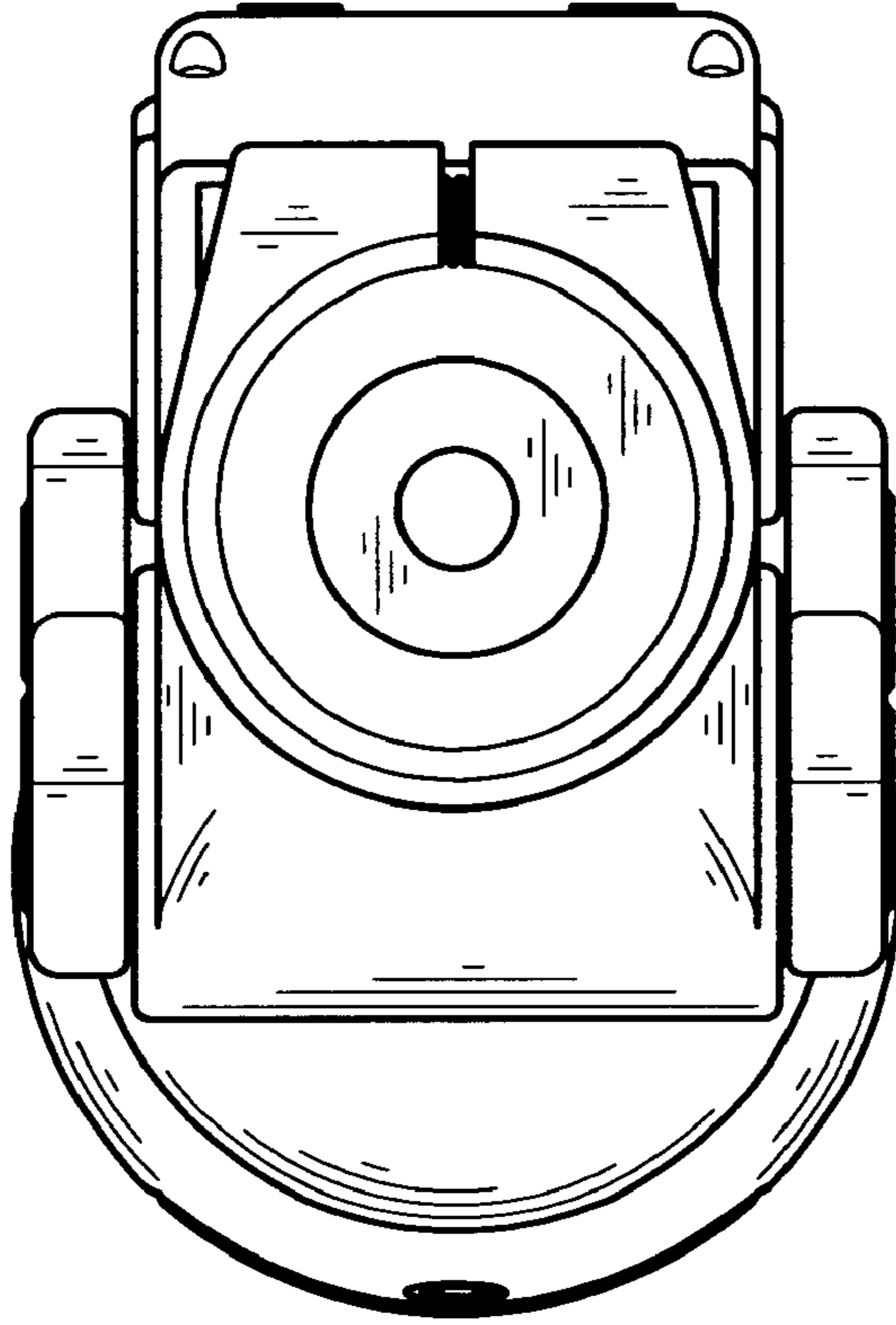

FIG. 7