



US00D526384S

(12) **United States Design Patent**
Wu

(10) **Patent No.:** **US D526,384 S**

(45) **Date of Patent:** **** Aug. 8, 2006**

(54) **HAND SHOWER**

(76) Inventor: **James Wu**, No. 1, Alley 16, Lane 40,
Jinde Rd., East District, Taichung City
401 (TW)

(**) Term: **14 Years**

(21) Appl. No.: **29/228,126**

(22) Filed: **Apr. 19, 2005**

(51) **LOC (8) Cl.** **23-01**

(52) **U.S. Cl.** **D23/223**

(58) **Field of Classification Search** D23/213,
D23/223–226, 229–230; 239/394, 282–283
See application file for complete search history.

(56) **References Cited**

U.S. PATENT DOCUMENTS

D428,110 S	*	7/2000	Haug et al.	D23/223
D432,624 S	*	10/2000	Chan	D23/223
D451,980 S	*	12/2001	Lindholm et al.	D23/223
D457,937 S	*	5/2002	Lindholm et al.	D23/223

D465,548 S	*	11/2002	Tse	D23/223
D506,243 S	*	6/2005	Wu	D23/223
D509,243 S	*	9/2005	Hunter et al.	D19/10

* cited by examiner

Primary Examiner—Robin Webster

(74) *Attorney, Agent, or Firm*—Pro-Techtor Int’l Services

(57) **CLAIM**

The ornamental design for a hand shower, as shown and described.

DESCRIPTION

FIG. 1. is a front-right-top perspective view of a hand shower, showing my new design;
FIG. 2. is a front elevational view thereof;
FIG. 3. is a rear elevational view thereof;
FIG. 4. is a left side elevational view thereof;
FIG. 5. is a right side elevational view thereof;
FIG. 6. is a top plan view thereof; and,
FIG. 7. is a bottom plan view thereof.

1 Claim, 7 Drawing Sheets

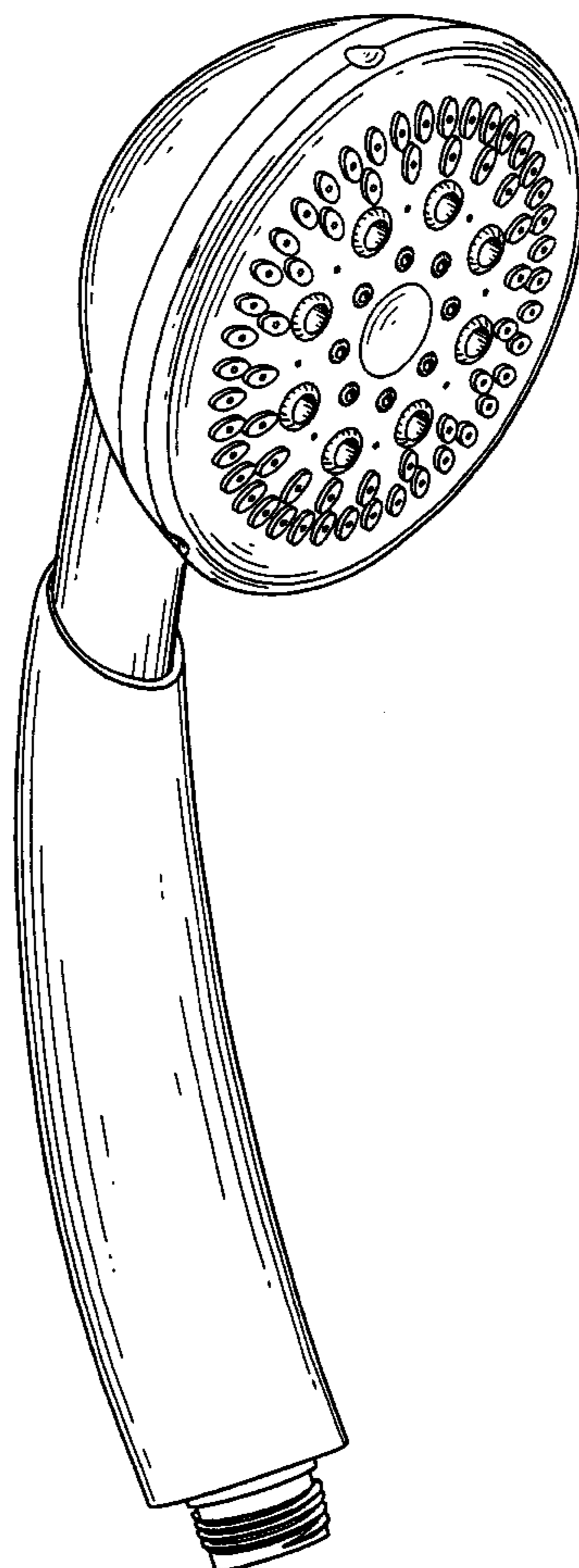

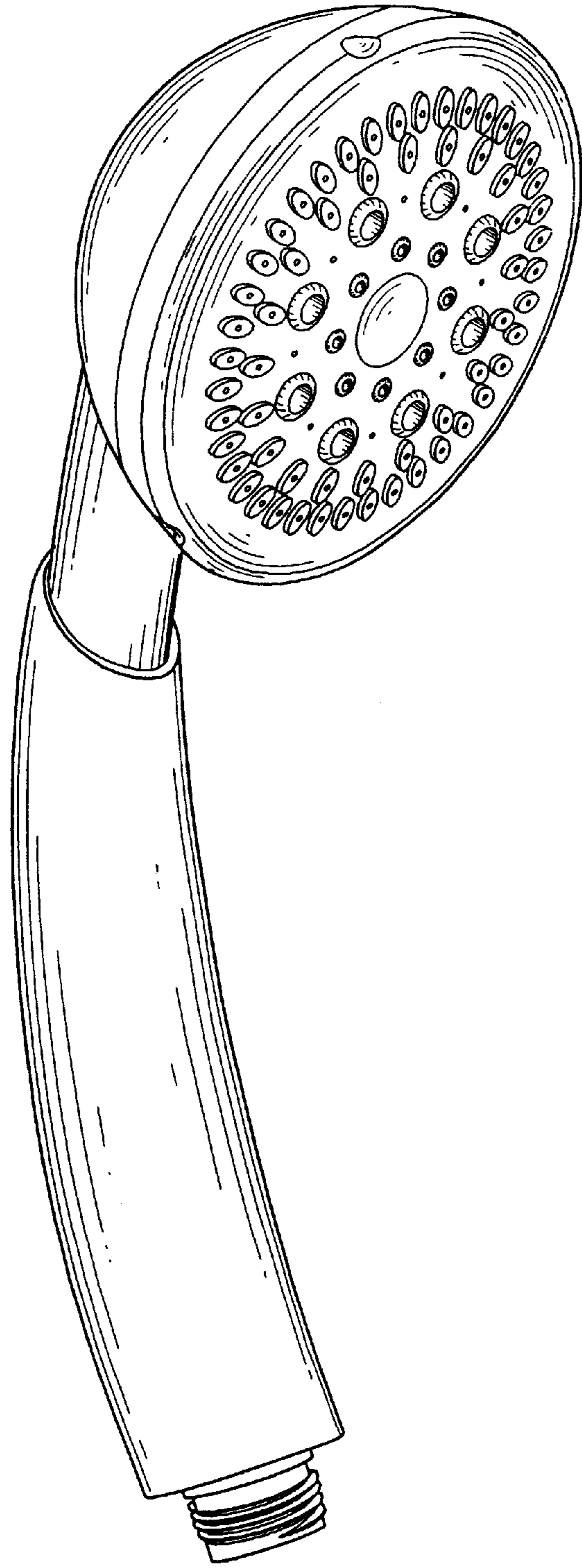

FIG. 1

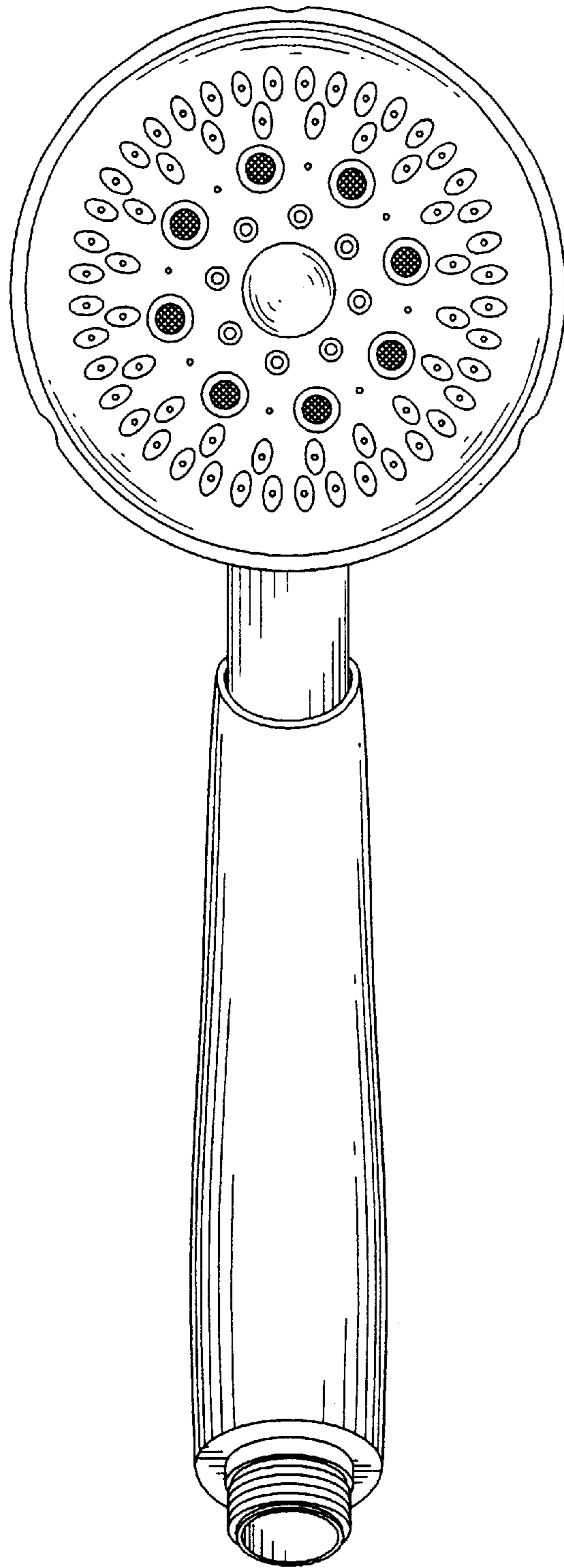

FIG. 2

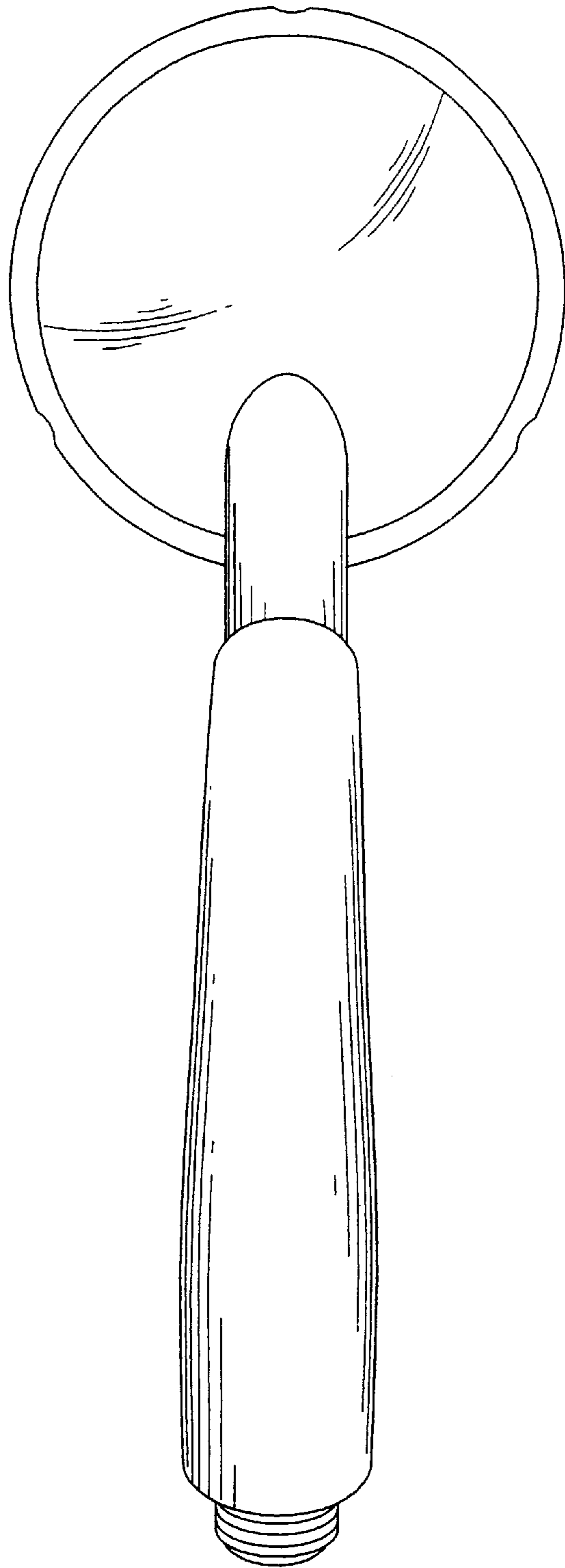

FIG. 3

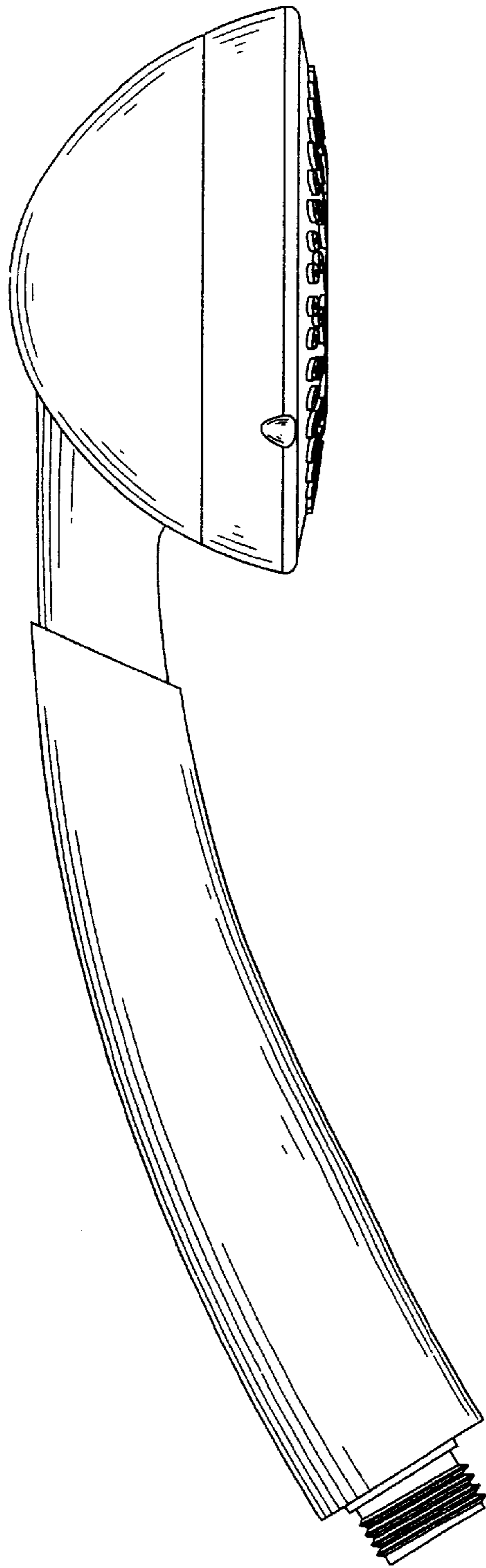

FIG. 4

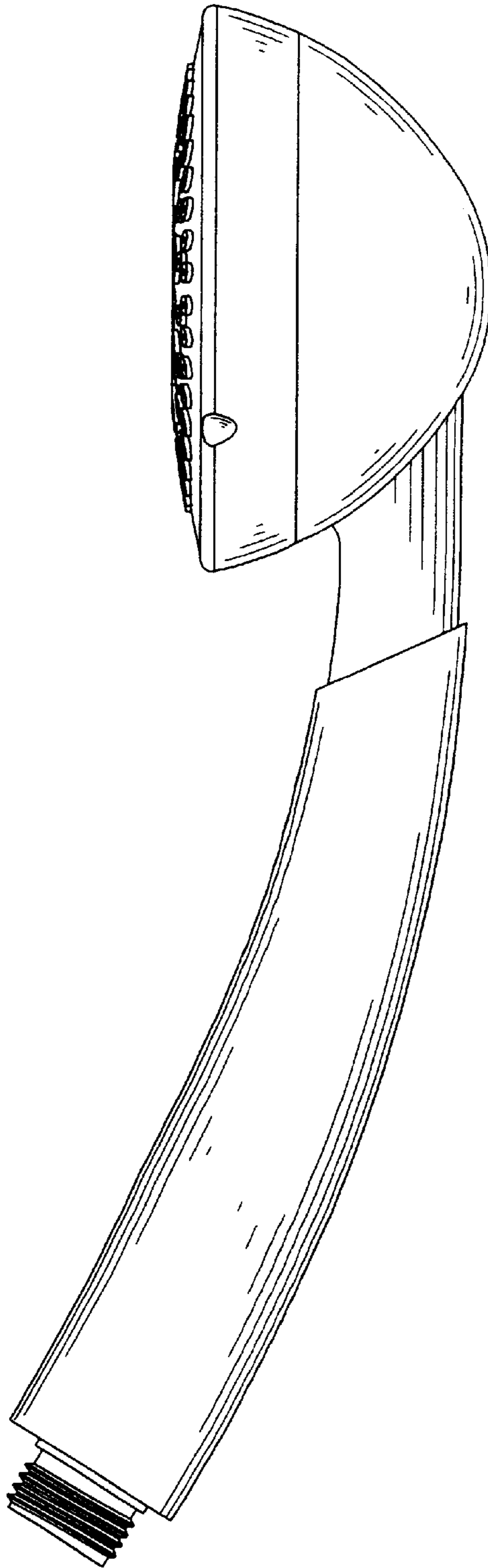

FIG. 5

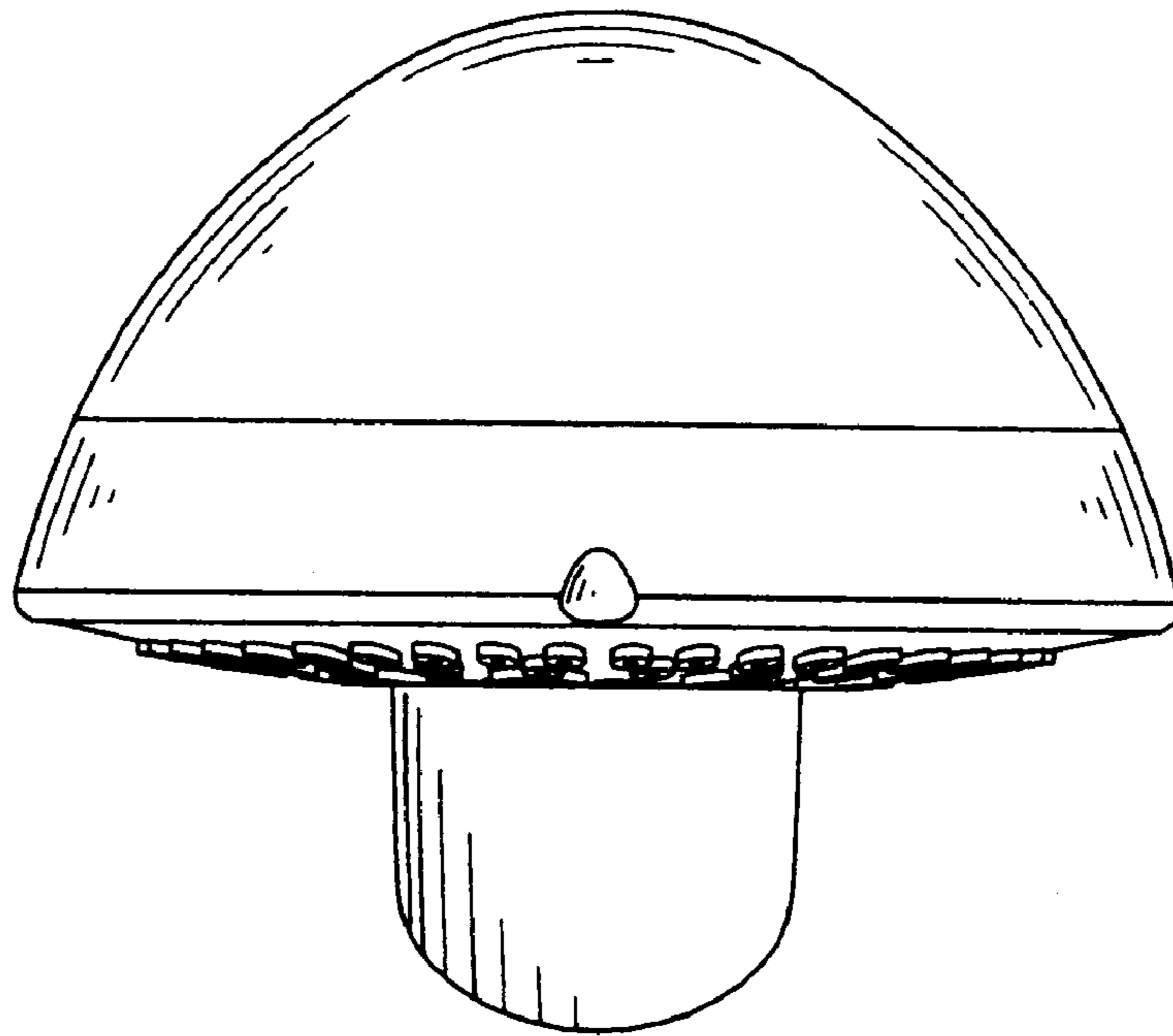

FIG. 6

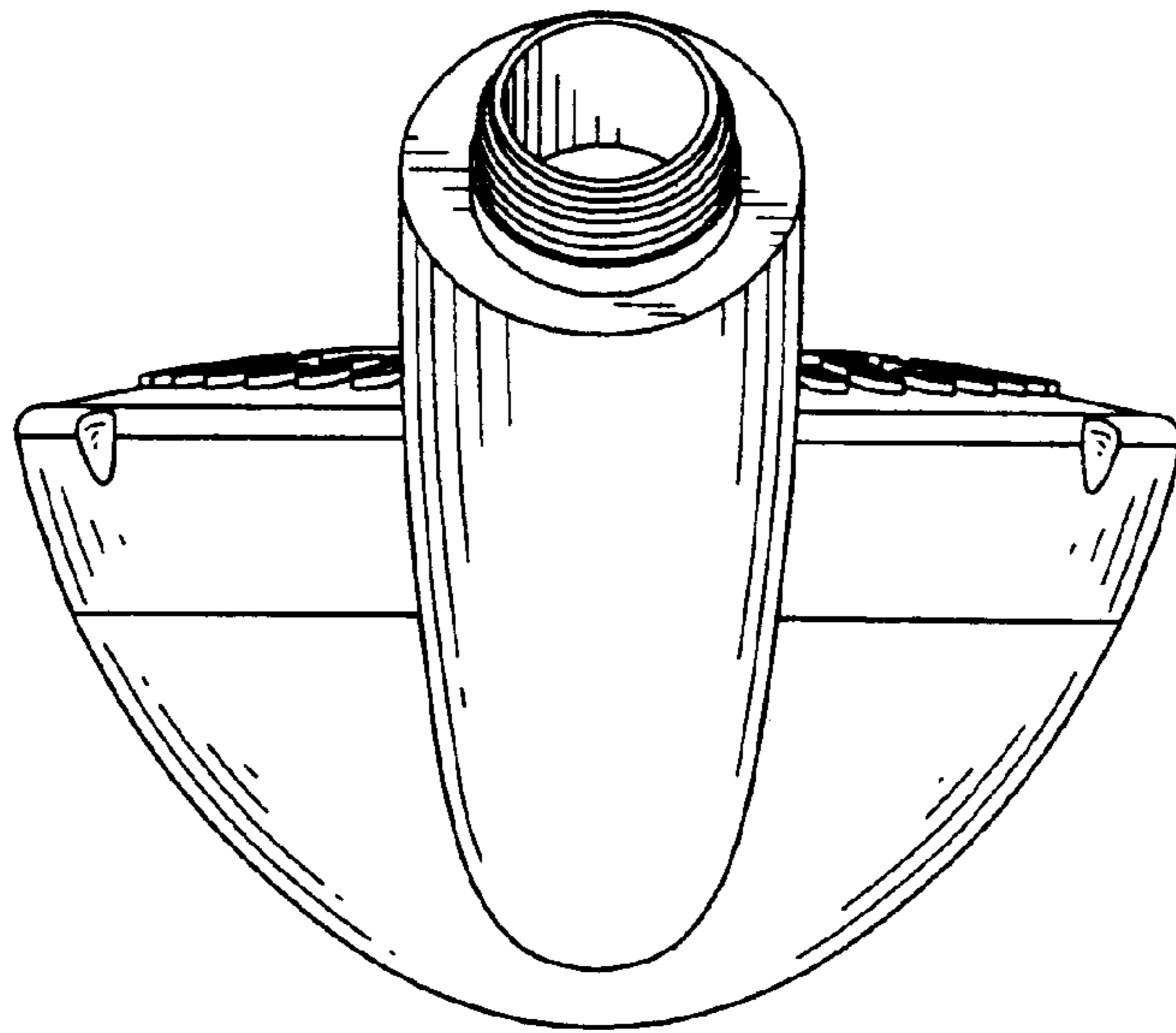

FIG. 7