



US00D526370S

(12) **United States Design Patent**
Bingham, Jr. et al.

(10) **Patent No.:** **US D526,370 S**

(45) **Date of Patent:** **** Aug. 8, 2006**

(54) **CONSOLE FOR EXERCISE MACHINES**

(75) Inventors: **Robert J. Bingham, Jr.**, Everett, WA (US); **Mark A. Zeh**, Munich (DE); **Christopher Loew**, Palo Alto, CA (US)

(73) Assignee: **LeMond Fitness, Inc.**, Woodinville, MA (US)

(**) Term: **14 Years**

(21) Appl. No.: **29/221,808**

(22) Filed: **Jan. 19, 2005**

Related U.S. Application Data

(63) Continuation-in-part of application No. 29/217,448, filed on Nov. 16, 2004.

(51) **LOC (8) Cl.** **21-02**

(52) **U.S. Cl.** **D21/696**

(58) **Field of Classification Search** D21/662, D21/665, 667, 668, 669, 670, 694, 696
See application file for complete search history.

(56) **References Cited**

U.S. PATENT DOCUMENTS

D407,771 S	*	4/1999	Garza	D21/694
D412,192 S	*	7/1999	Birrell et al.	D21/696
D416,298 S	*	11/1999	Onuma et al.	D21/669
D429,509 S	*	8/2000	Garza	D21/696
D438,579 S	*	3/2001	Arnold et al.	D21/696
D444,828 S	*	7/2001	Matsumoto	D21/696
D445,152 S	*	7/2001	Wang et al.	D21/669
D454,931 S	*	3/2002	Fon	D21/696

D459,421 S	*	6/2002	Lee	D21/696
D485,589 S	*	1/2004	Briganti	D21/696
6,761,669 B1	*	7/2004	Pan et al.	482/54

* cited by examiner

Primary Examiner—Philip S. Hyder

(74) *Attorney, Agent, or Firm*—George C. Rondeau, Jr.; Davis Wright Tremaine LLP

(57) **CLAIM**

The ornamental design for a console for exercise machines, as shown and described.

DESCRIPTION

FIG. 1 is a top perspective view of a console for exercise machine showing our new design.

FIG. 2 is a top plan view thereof.

FIG. 3 is a bottom plan view thereof.

FIG. 4 is a front elevational view thereof.

FIG. 5 is a rear elevational view thereof.

FIG. 6 is a right side elevational view thereof.

FIG. 7 is a left side elevational view thereof.

FIG. 8 is a top perspective view of a second embodiment thereof.

FIG. 9 is a top plan view thereof.

FIG. 10 is a bottom plan view thereof.

FIG. 11 is a front elevational view thereof.

FIG. 12 is a rear elevational view thereof.

FIG. 13 is a right side elevational view thereof; and,

FIG. 14 is a left side elevational view thereof.

The broken lines are for illustrative purposes only and form no part of the claimed design.

1 Claim, 10 Drawing Sheets

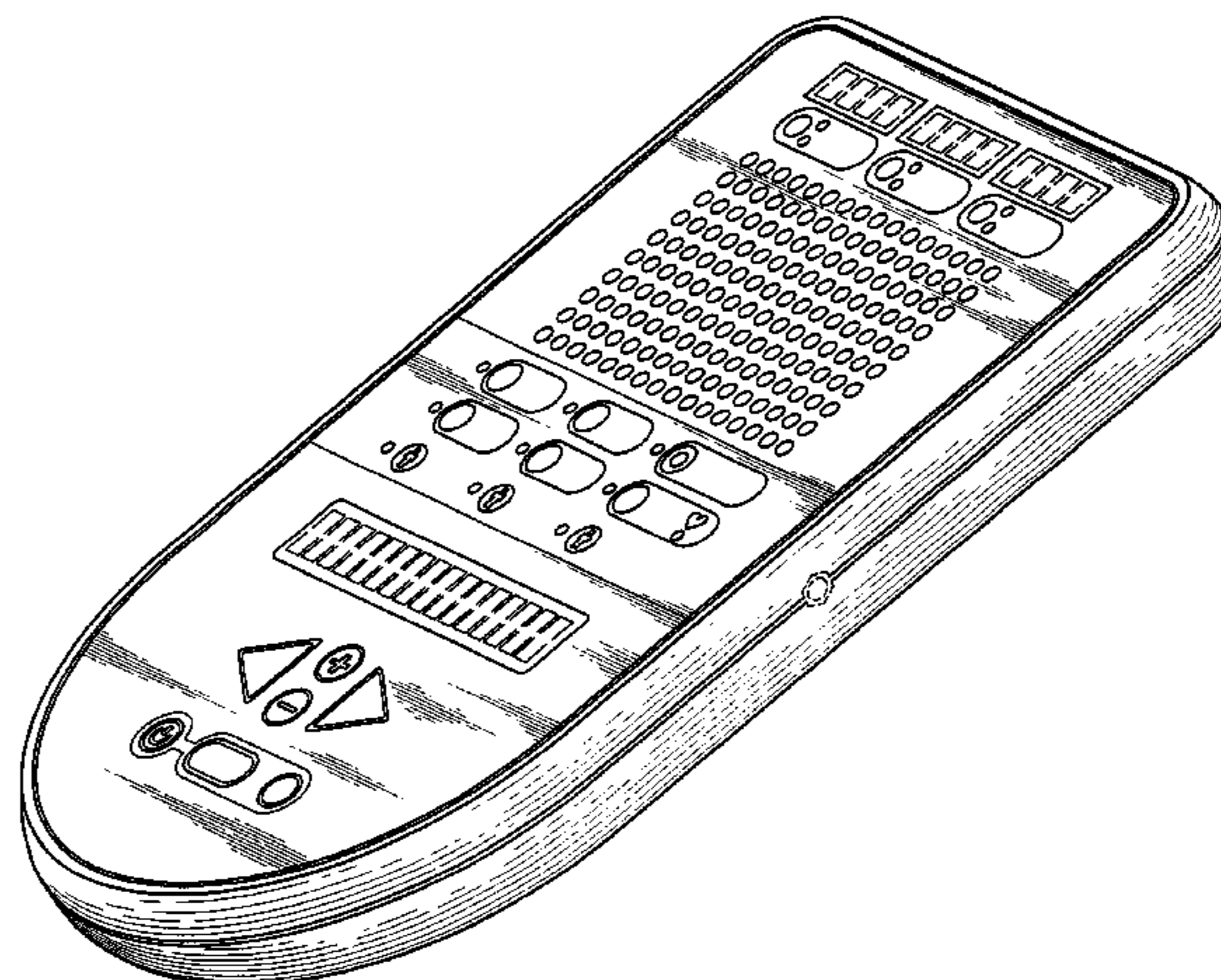
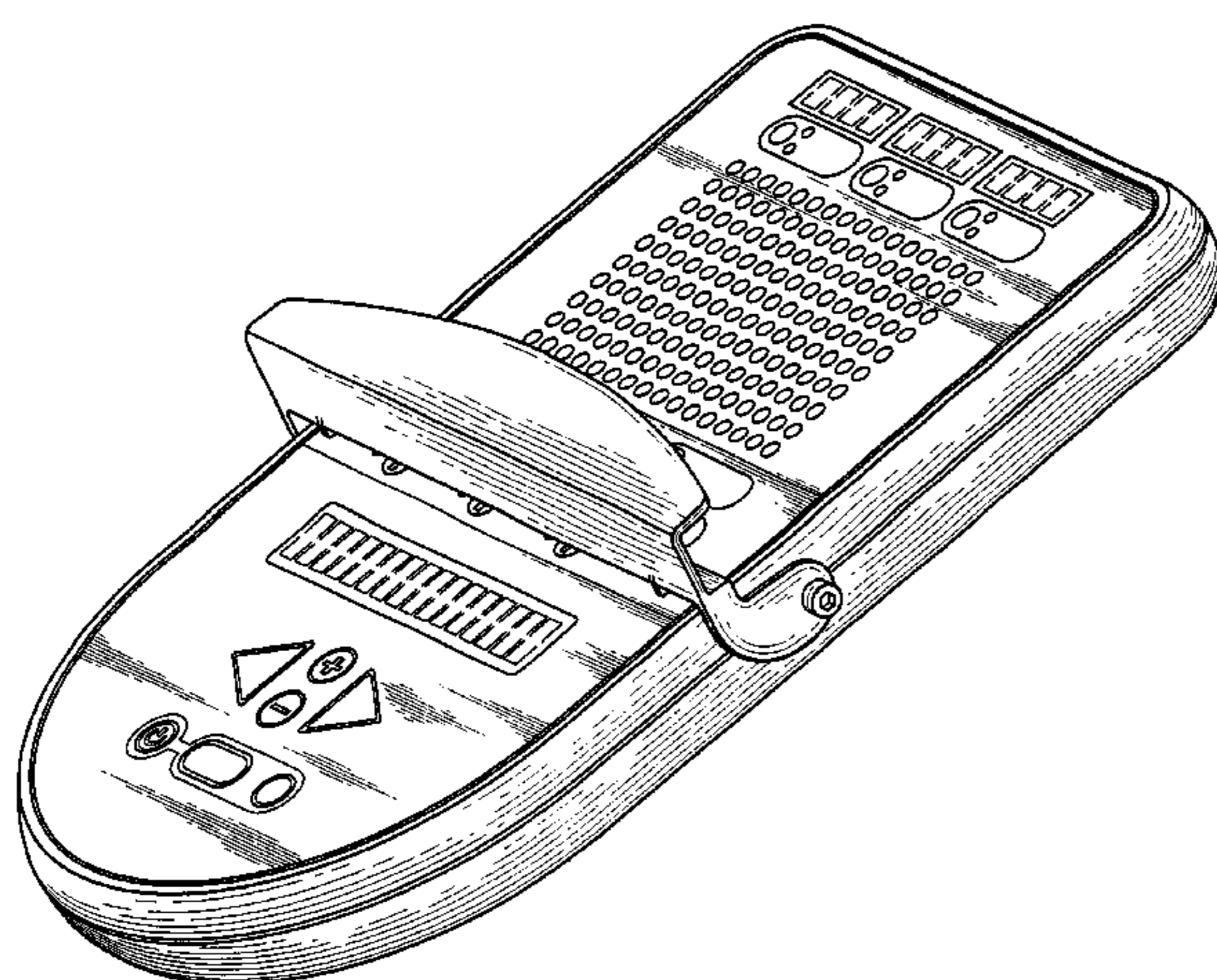

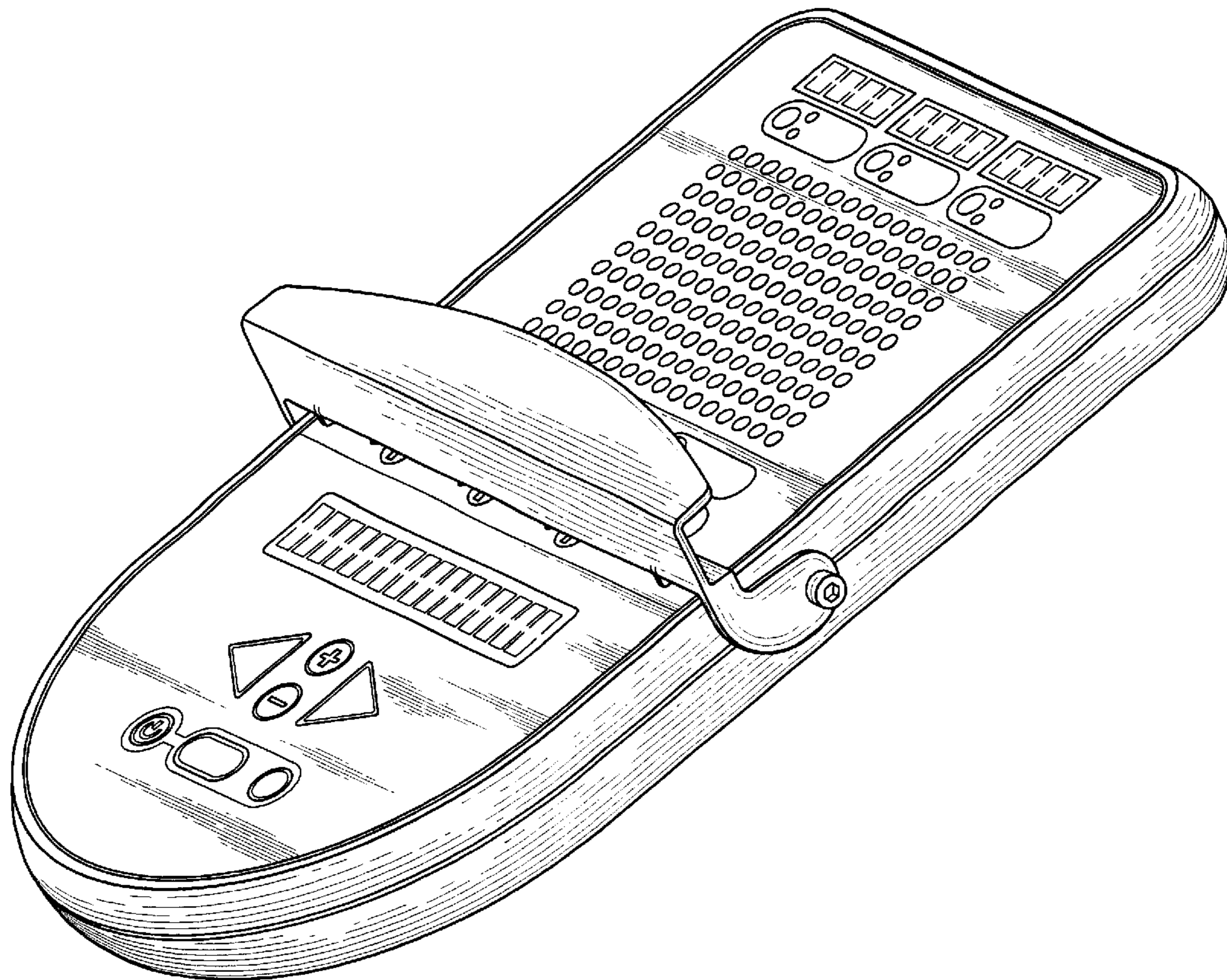

Fig. 1

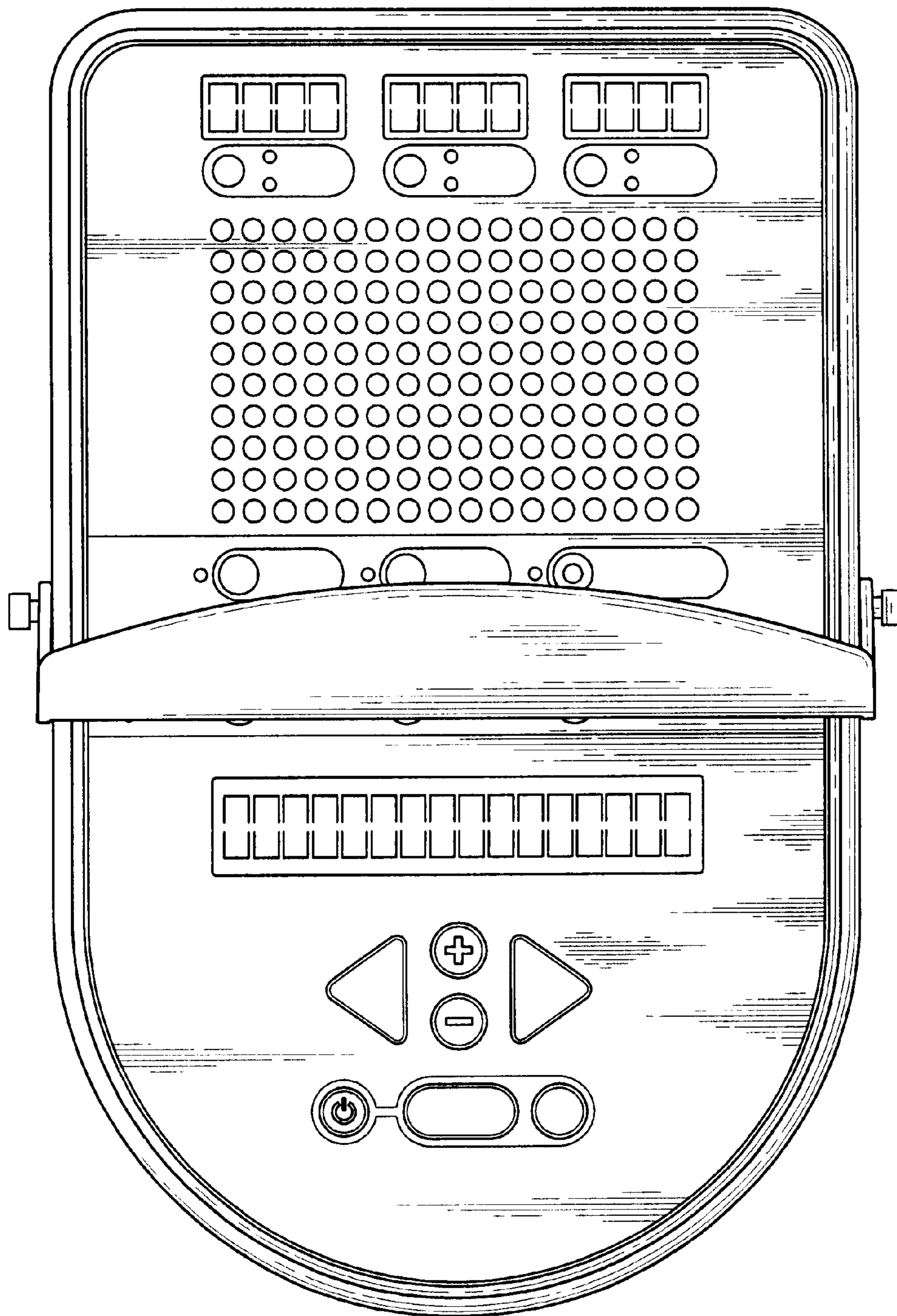

Fig. 2

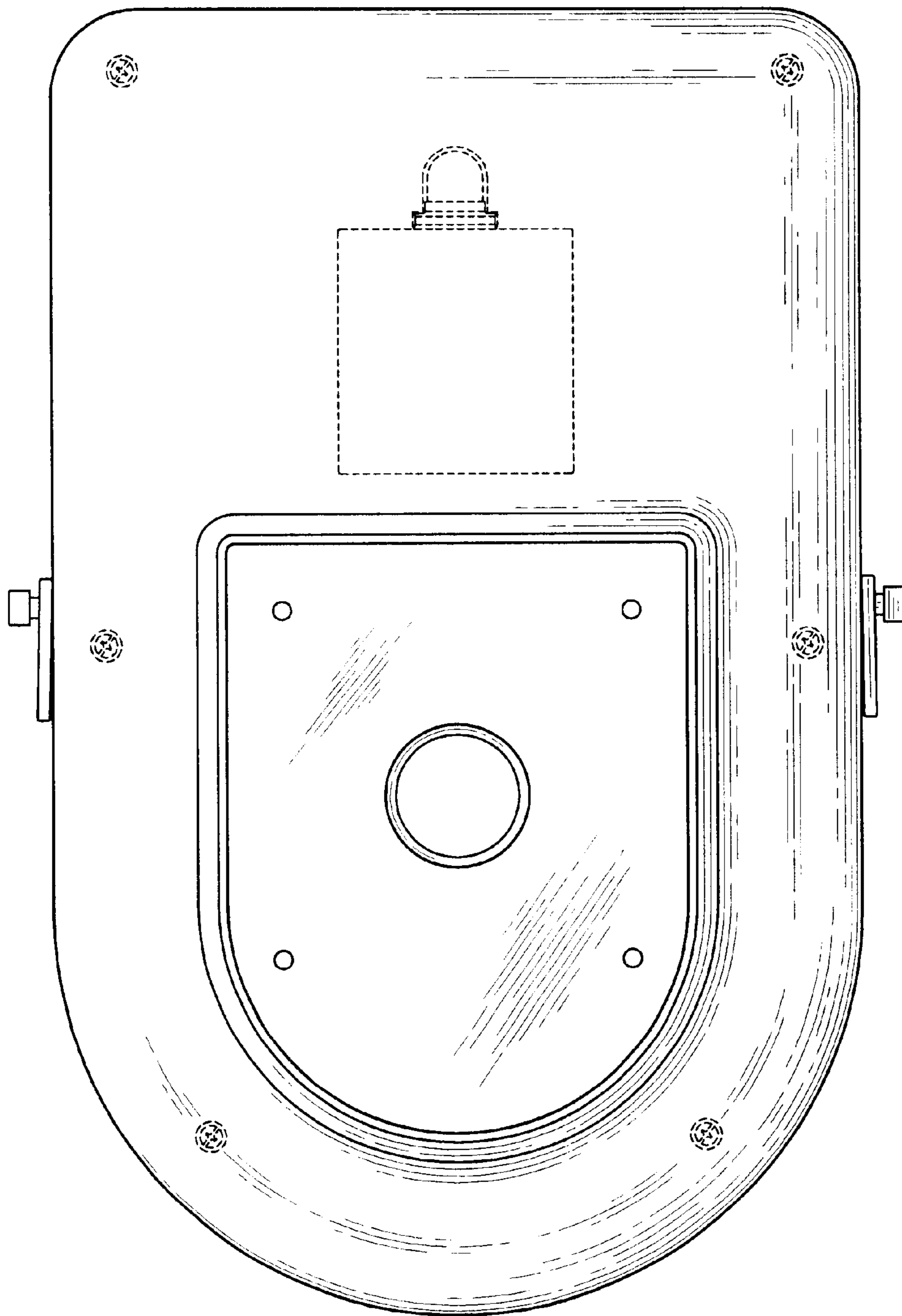

Fig. 3

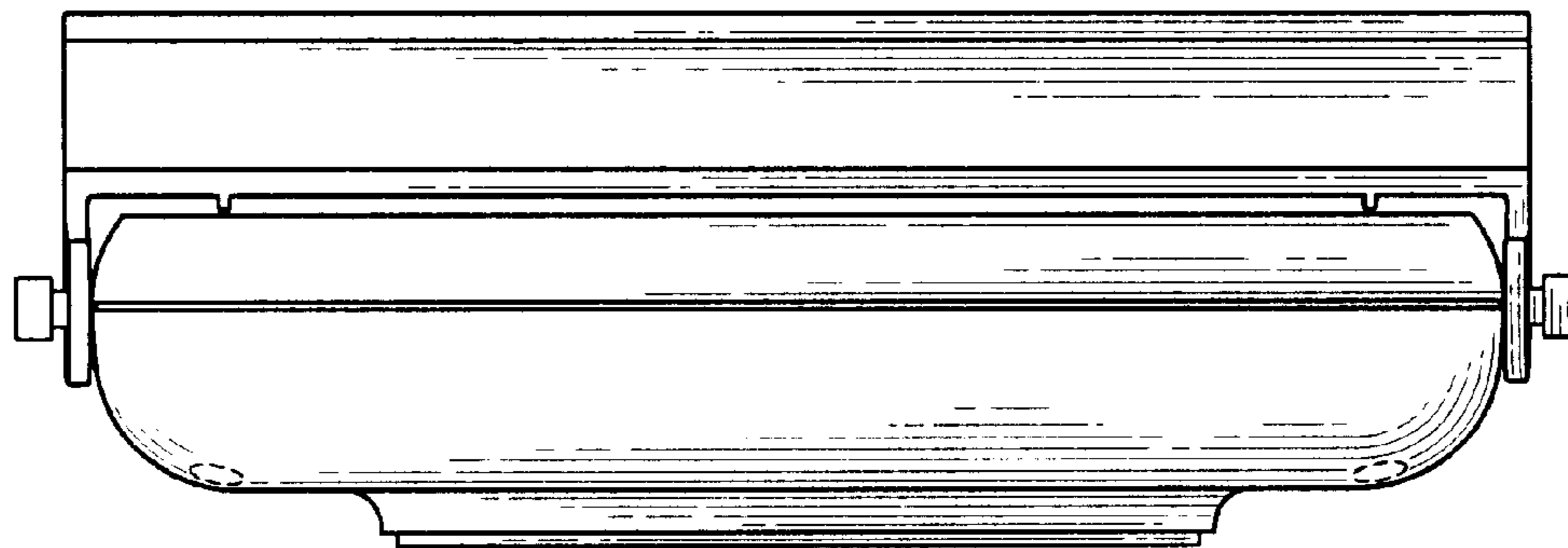

Fig. 4

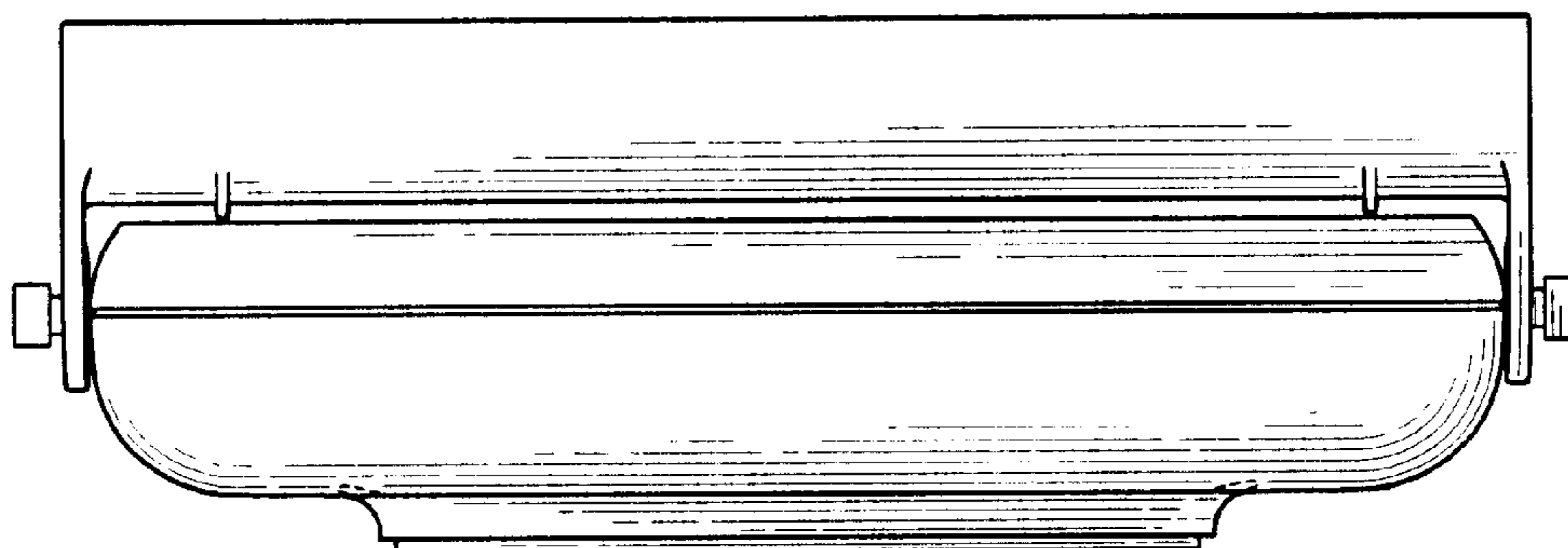

Fig. 5

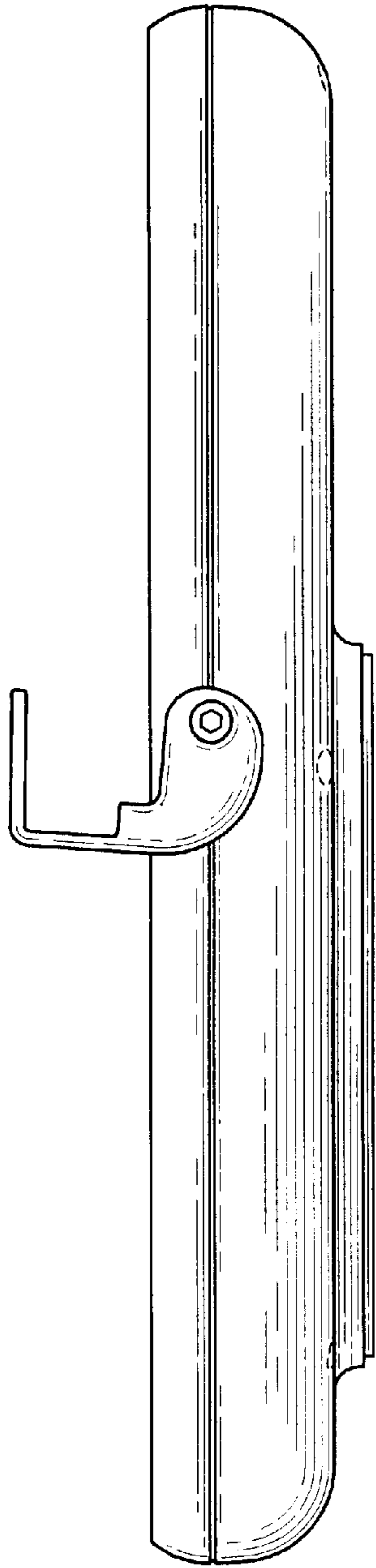

Fig. 6

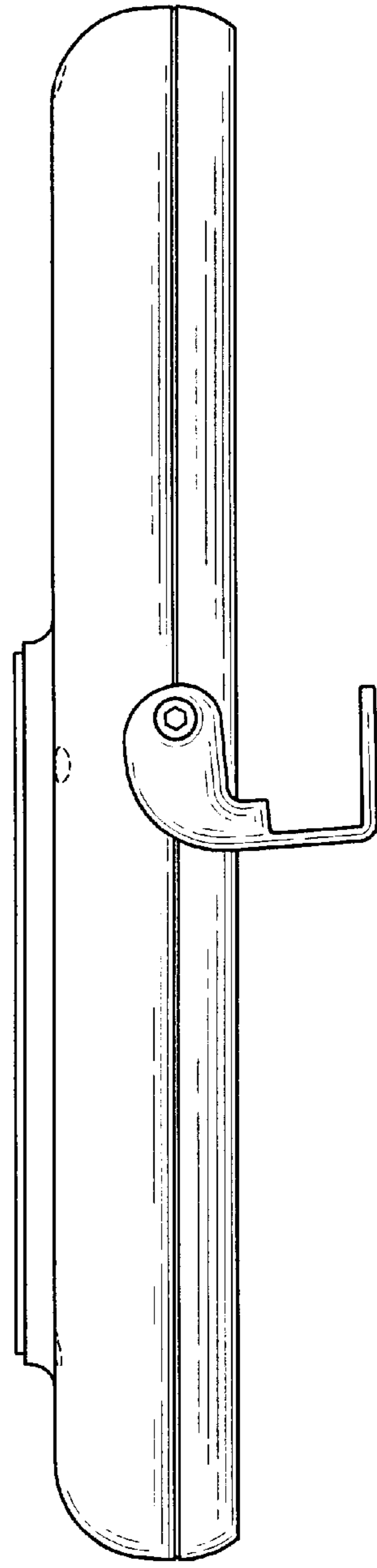

Fig. 7

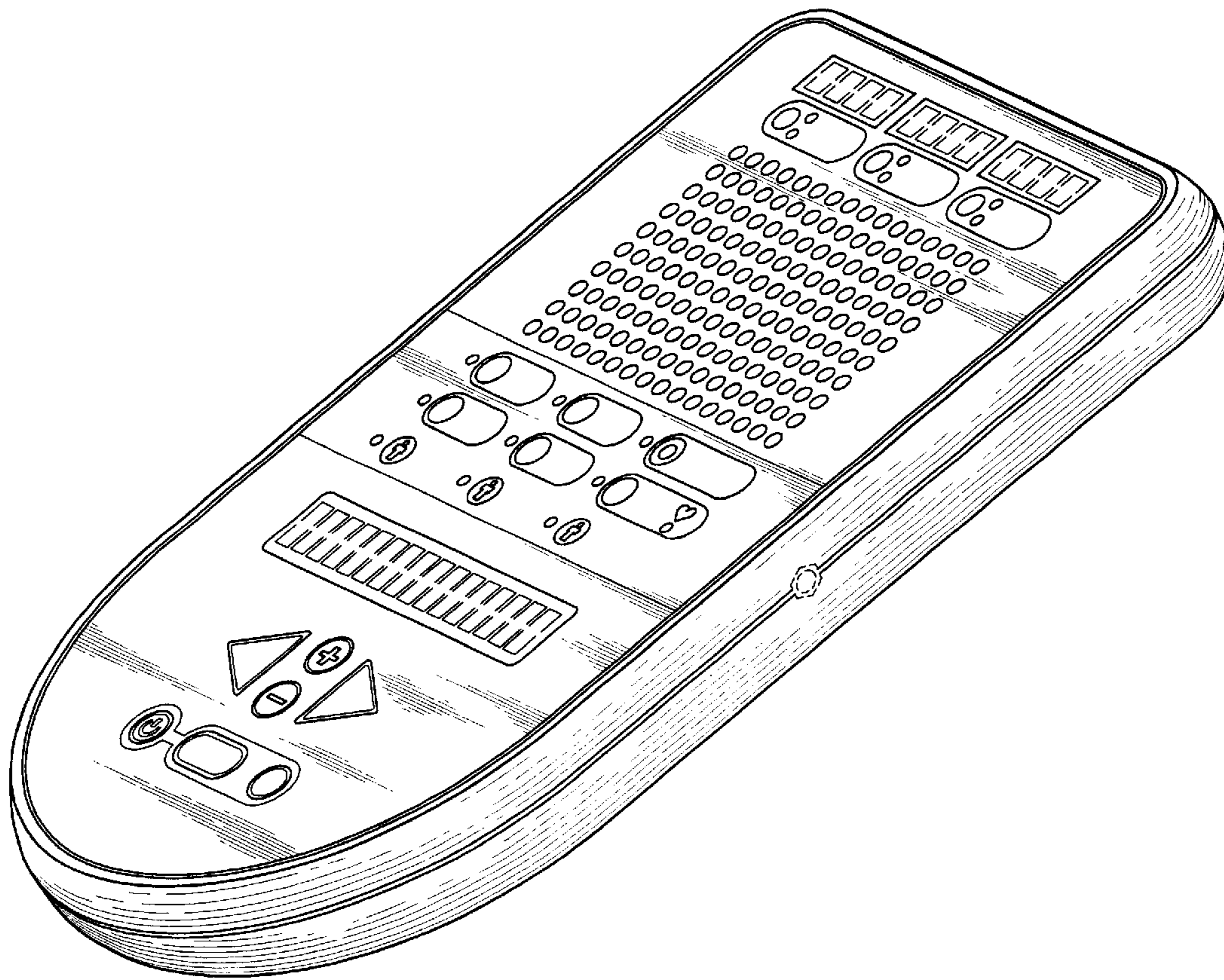

Fig. 8

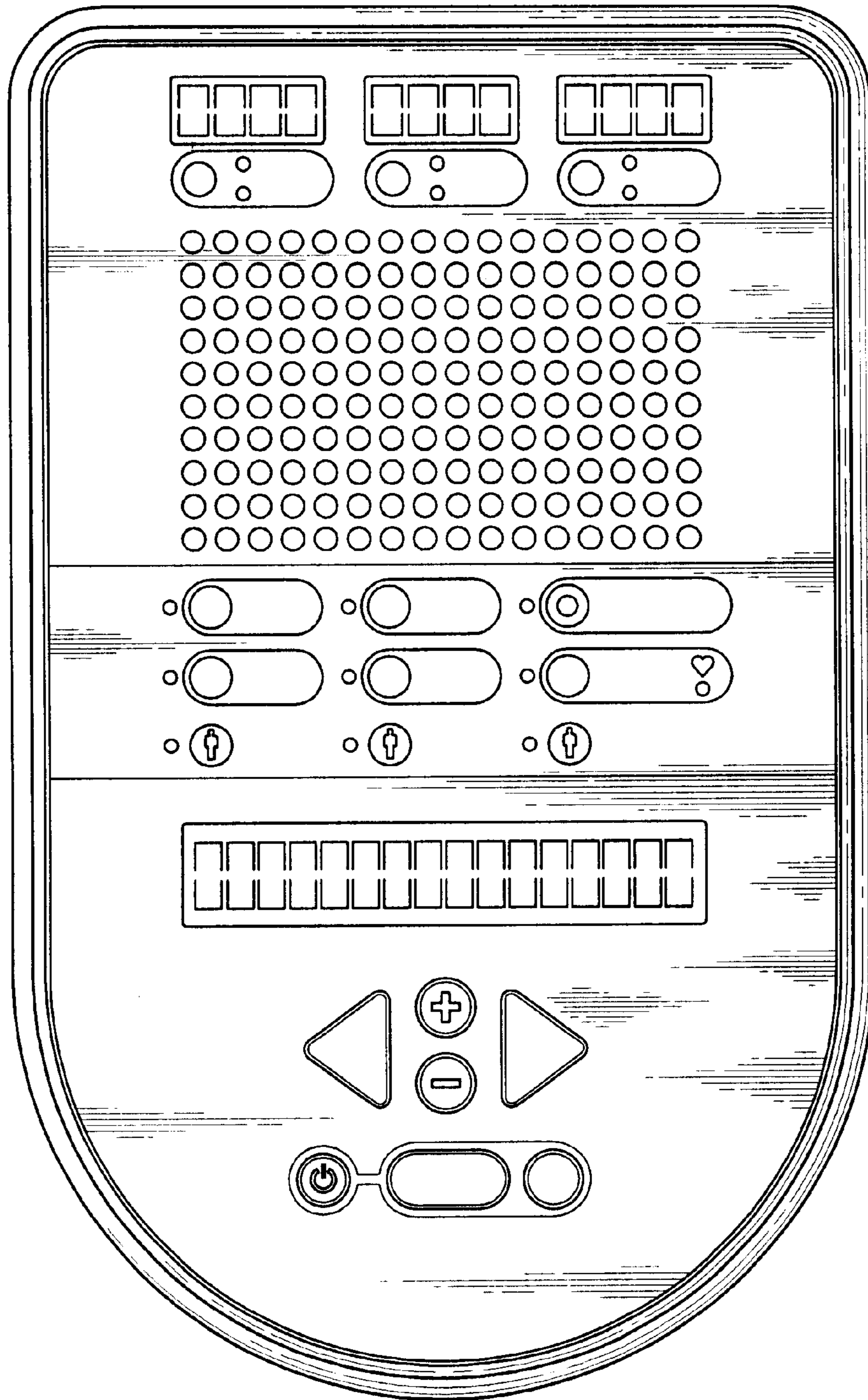

Fig. 9

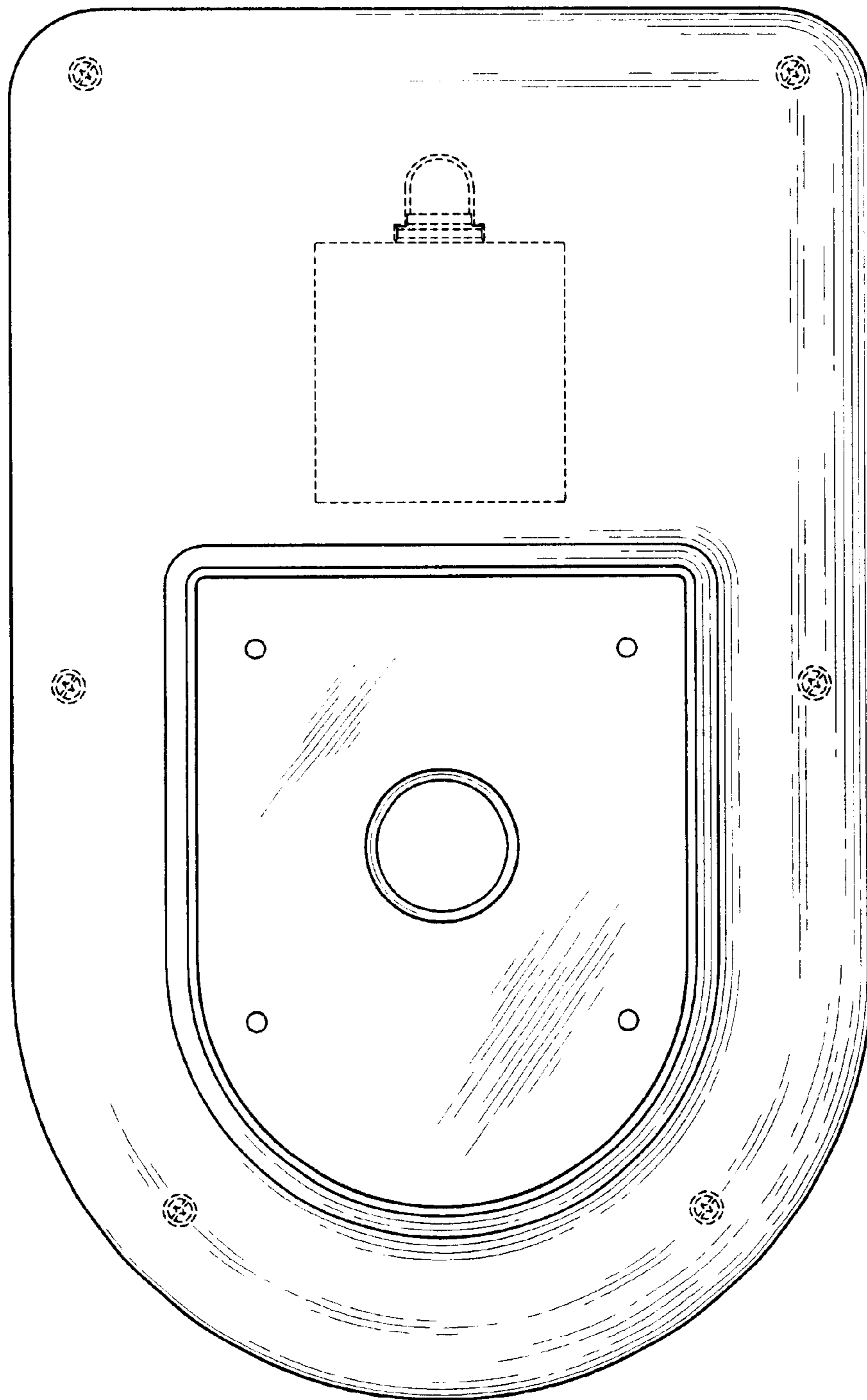

Fig. 10

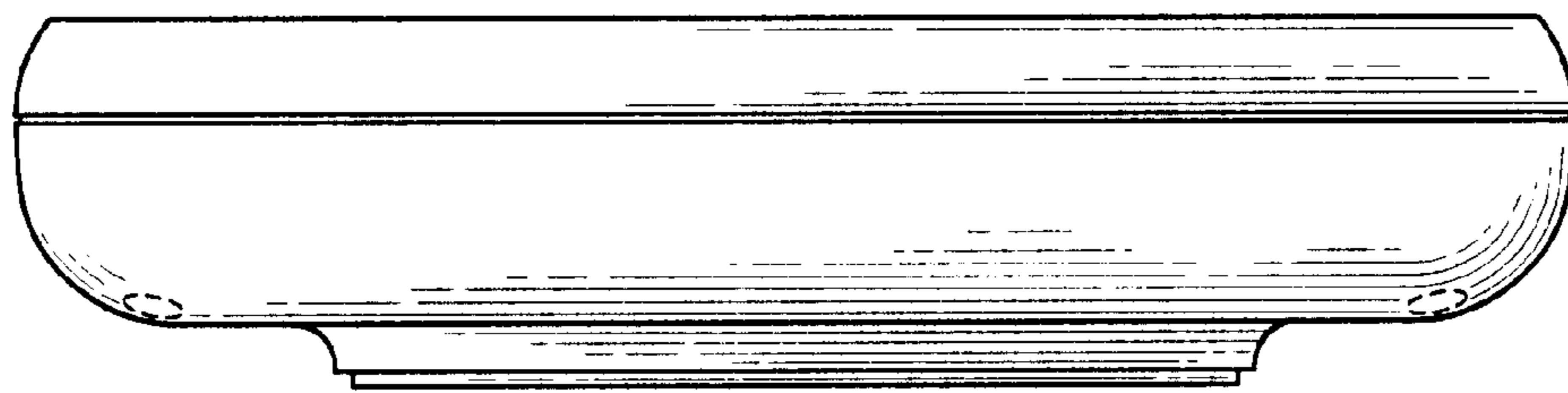

Fig. 11

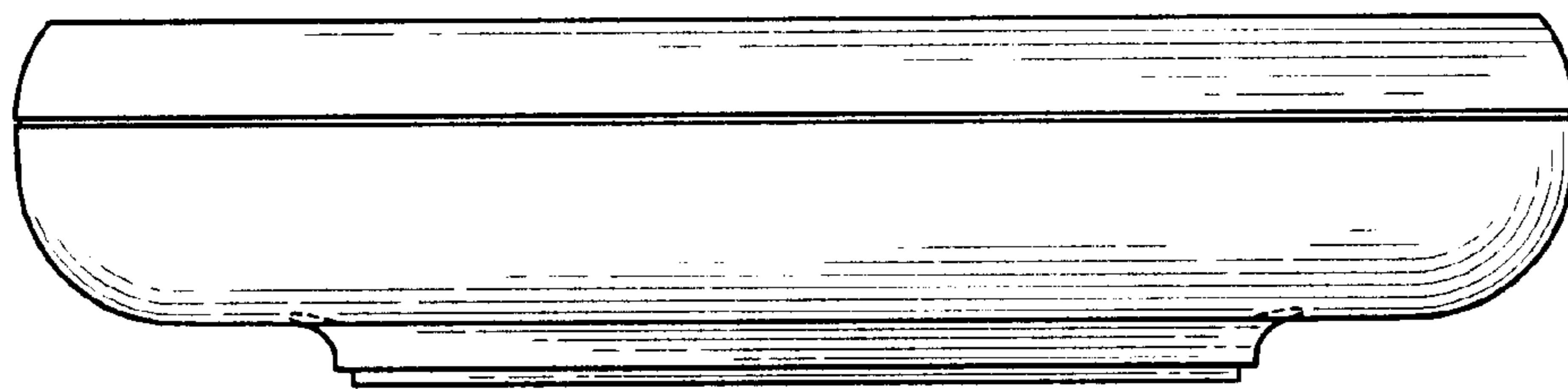

Fig. 12

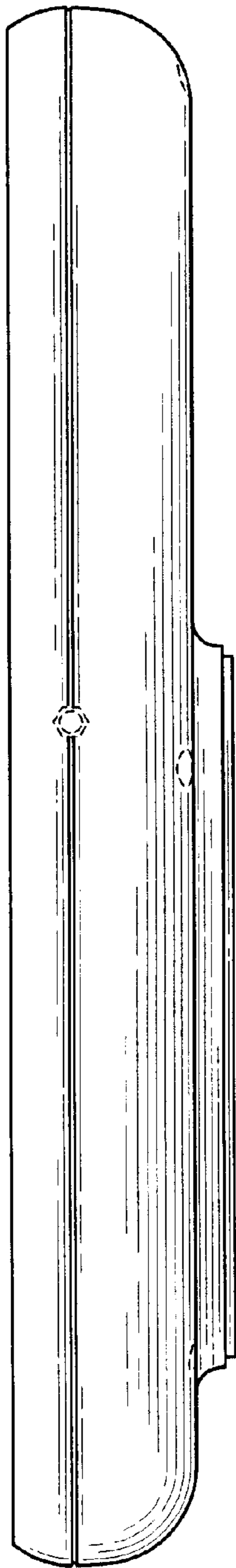

Fig. 13

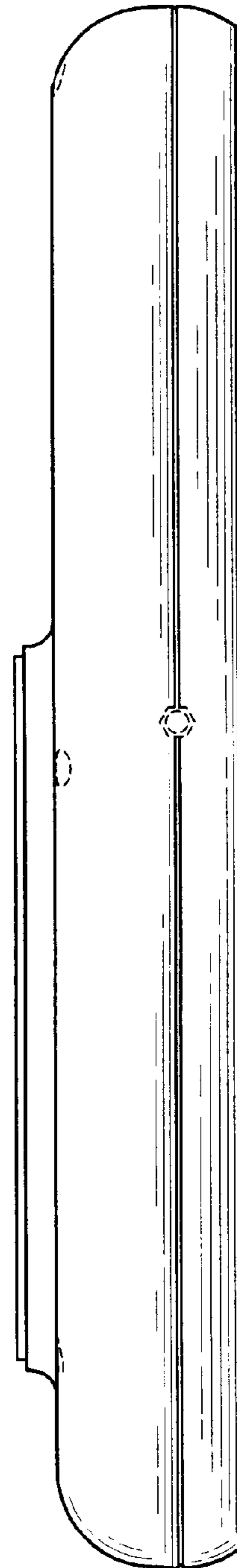

Fig. 14