



US00D526360S

(12) **United States Design Patent** (10) **Patent No.:** **US D526,360 S**
Yasuoka et al. (45) **Date of Patent:** **** Aug. 8, 2006**

(54) **MASK FOR A DISPLAY UNIT AND DISPLAY UNIT FOR AN ELECTRONIC DISPLAY BOARD**

(75) Inventors: **Tuyoshi Yasuoka**, Tokushima-Ken (JP); **Akiko Yamamoto**, Tokushima-Ken (JP)

(73) Assignee: **Nichia Corporation** (JP)

(**) Term: **14 Years**

(21) Appl. No.: **29/234,238**

(22) Filed: **Jul. 15, 2005**

Related U.S. Application Data

(62) Division of application No. 29/225,025, filed on Mar. 10, 2005, now Pat. No. Des. 510,956, which is a division of application No. 29/217,610, filed on Nov. 19, 2004, now Pat. No. Des. 506,510, which is a division of application No. 29/194,759, filed on Dec. 1, 2003, now Pat. No. Des. 503,745.

(30) Foreign Application Priority Data

May 30, 2003 (JP) 2003-015427
May 30, 2003 (JP) 2003-015428
May 30, 2003 (JP) 2003-015429
May 30, 2003 (JP) 2003-015430
May 30, 2003 (JP) 2003-019266
May 30, 2003 (JP) 2003-019267

(51) **LOC (8) Cl.** **20-02**

(52) **U.S. Cl.** **D20/10; D20/12; D20/19**

(58) **Field of Classification Search** D20/10, D20/18-21, 39, 40-42, 99; D10/46.1; 40/448-454, 40/541-2, 553, 573, 584; 52/38, 73; 340/323; 712/217

See application file for complete search history.

(56) References Cited

U.S. PATENT DOCUMENTS

D62,554 S * 6/1923 Lord D5/58

D368,117 S * 3/1996 Valls et al. D20/40
D382,906 S * 8/1997 Bach et al. D20/10
D388,123 S * 12/1997 Sukumoda et al. D20/10
D392,143 S * 3/1998 Farrell D6/570
D393,659 S * 4/1998 Muhlack D20/10
D445,922 S * 7/2001 Yasuoka D26/1
6,314,669 B1 * 11/2001 Tucker 40/605
D482,403 S * 11/2003 Rose D20/19
D487,779 S * 3/2004 Rose D20/19
2003/0217495 A1 * 11/2003 Nagamine et al. 40/605

* cited by examiner

Primary Examiner—Robert M. Spear

(74) *Attorney, Agent, or Firm*—Osha Liang LLP

(57) CLAIM

The ornamental design for a mask for a display unit and display unit for an electronic display board, as shown and described.

DESCRIPTION

FIG. 1 shows a front view of the design according to a new design.

FIG. 2 shows a top view of the design thereof.

FIG. 3 shows a bottom view of the design thereof.

FIG. 4 shows a sectional view of the design thereof taken along the line 4—4 as shown in FIG. 1.

FIG. 5 shows an enlarged sectional view of the design thereof taken along the line 5—5 in FIG. 4;

FIG. 6 shows an enlarged sectional view of the design thereof taken along the line 6—6 in FIG. 4;

FIG. 7 shows a rear view of the design thereof; and,

FIG. 8 shows a perspective view of the design thereof.

1 Claim, 4 Drawing Sheets

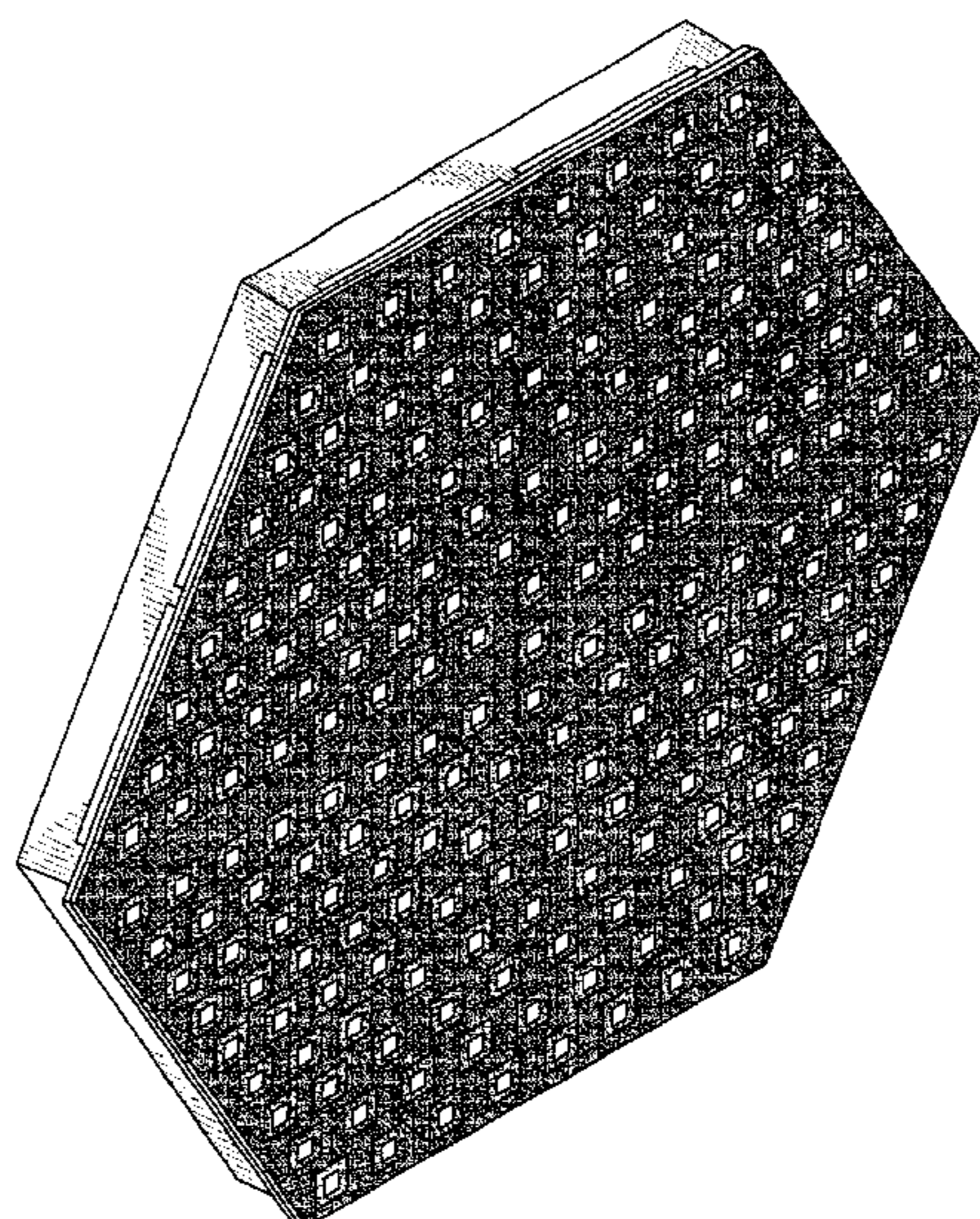

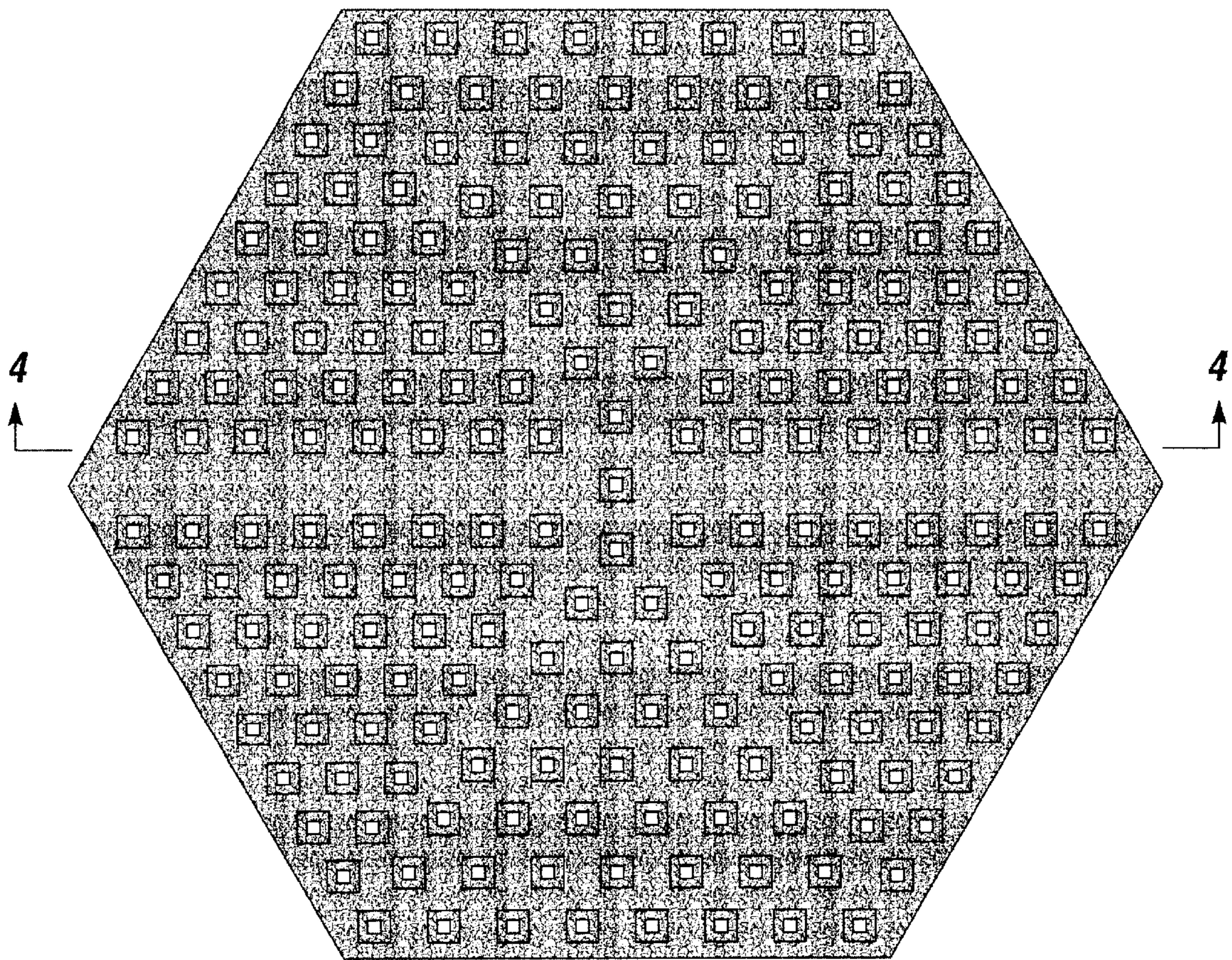

FIG. 1

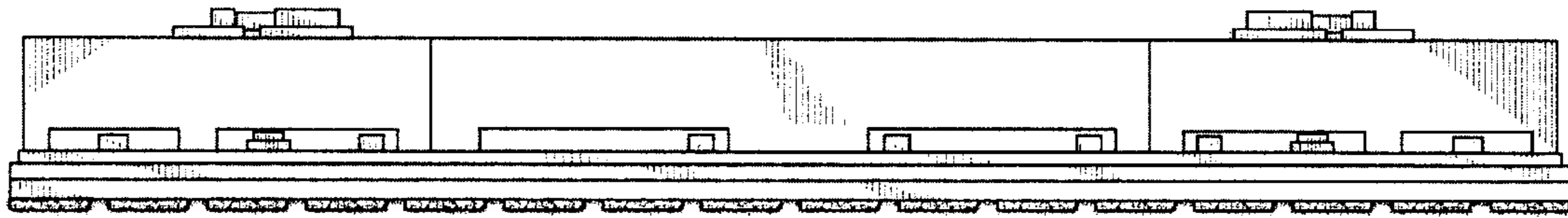

FIG. 2

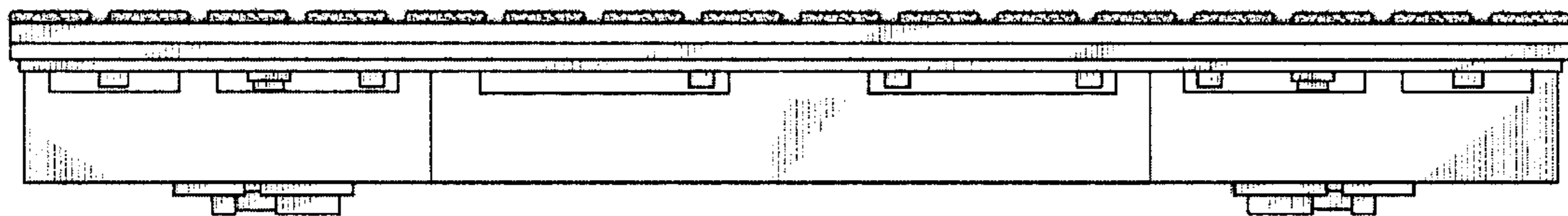

FIG. 3

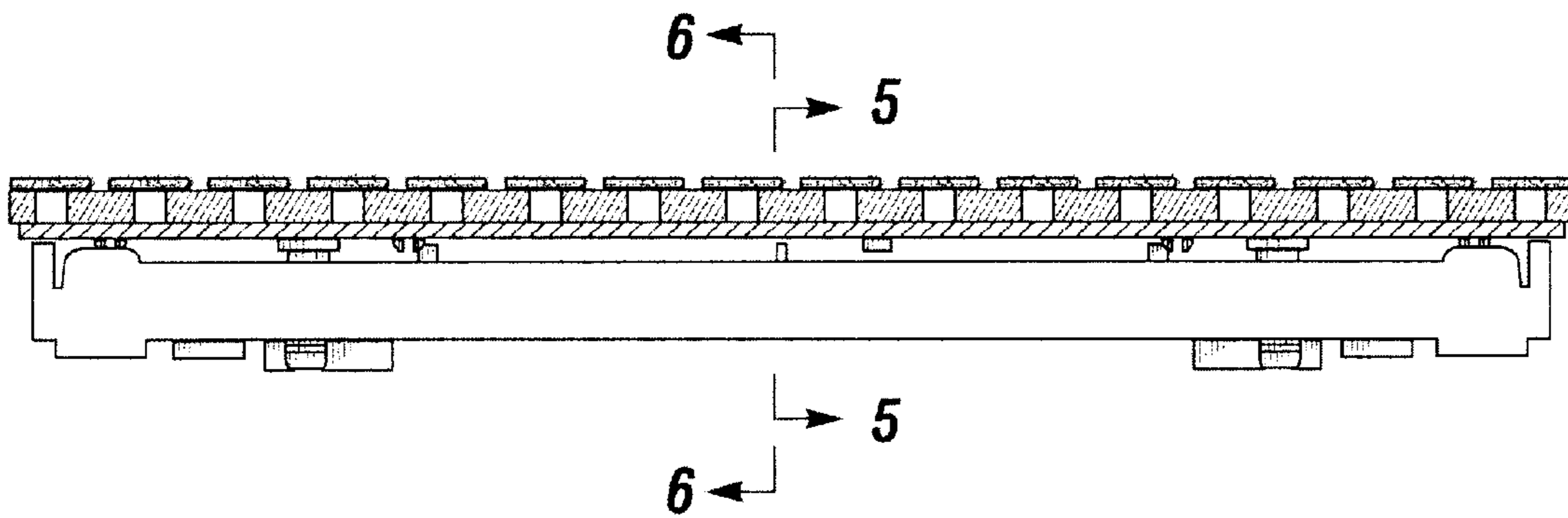

FIG. 4

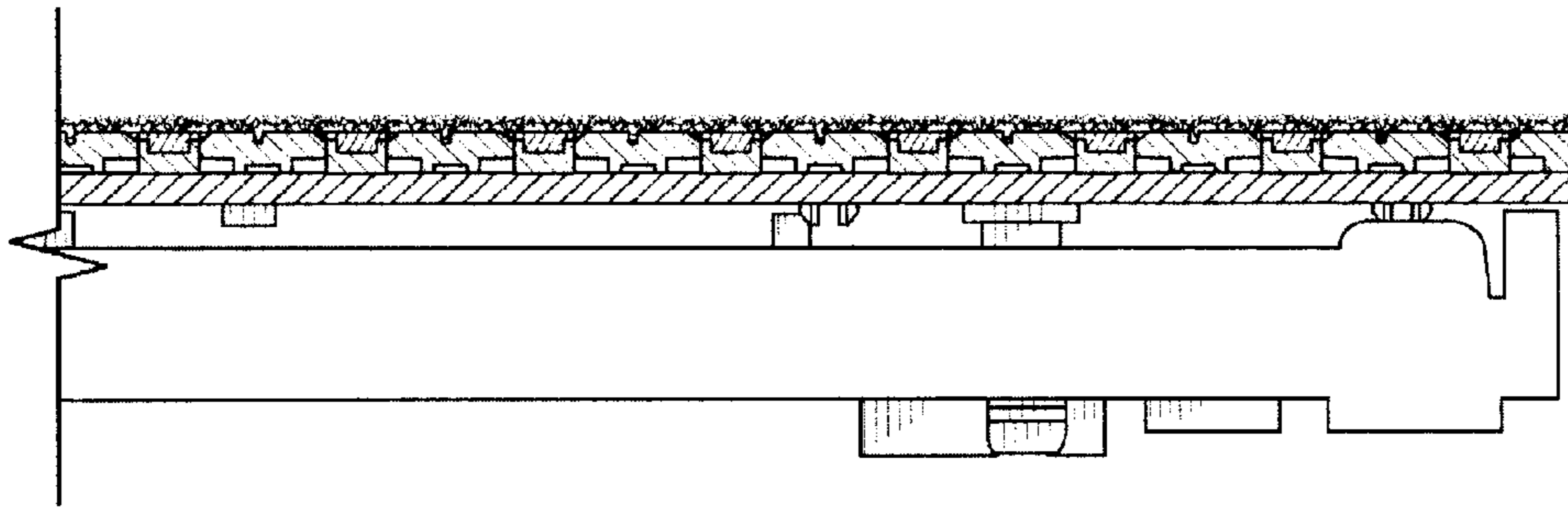

FIG. 5

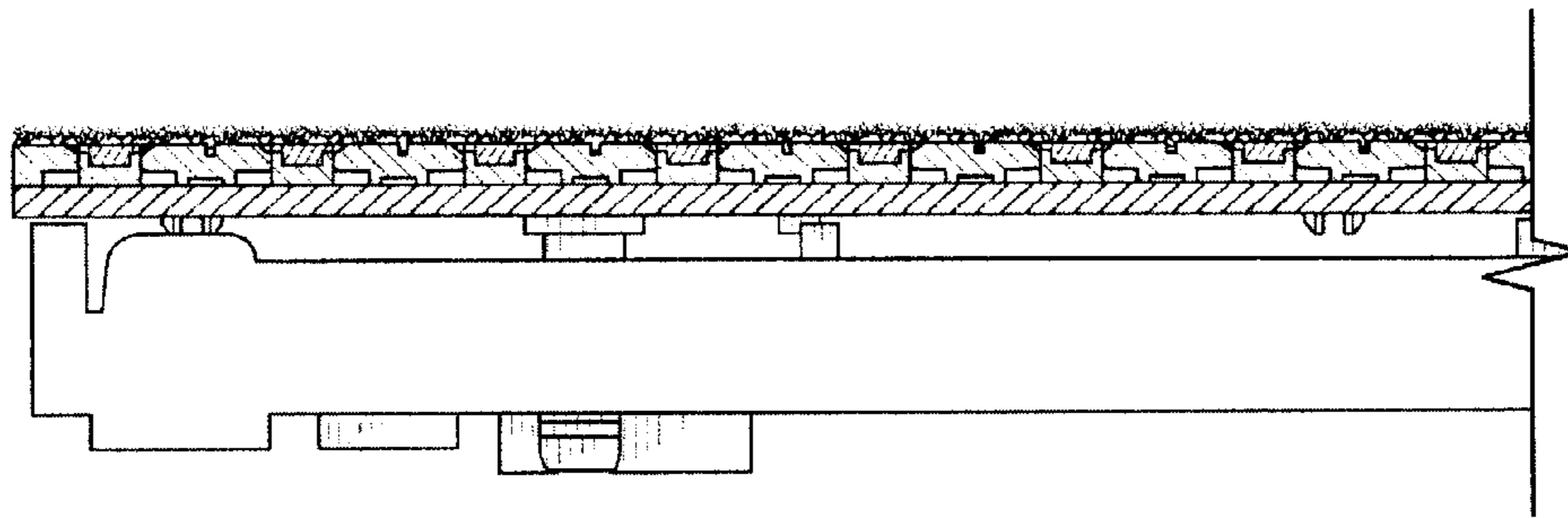

FIG. 6

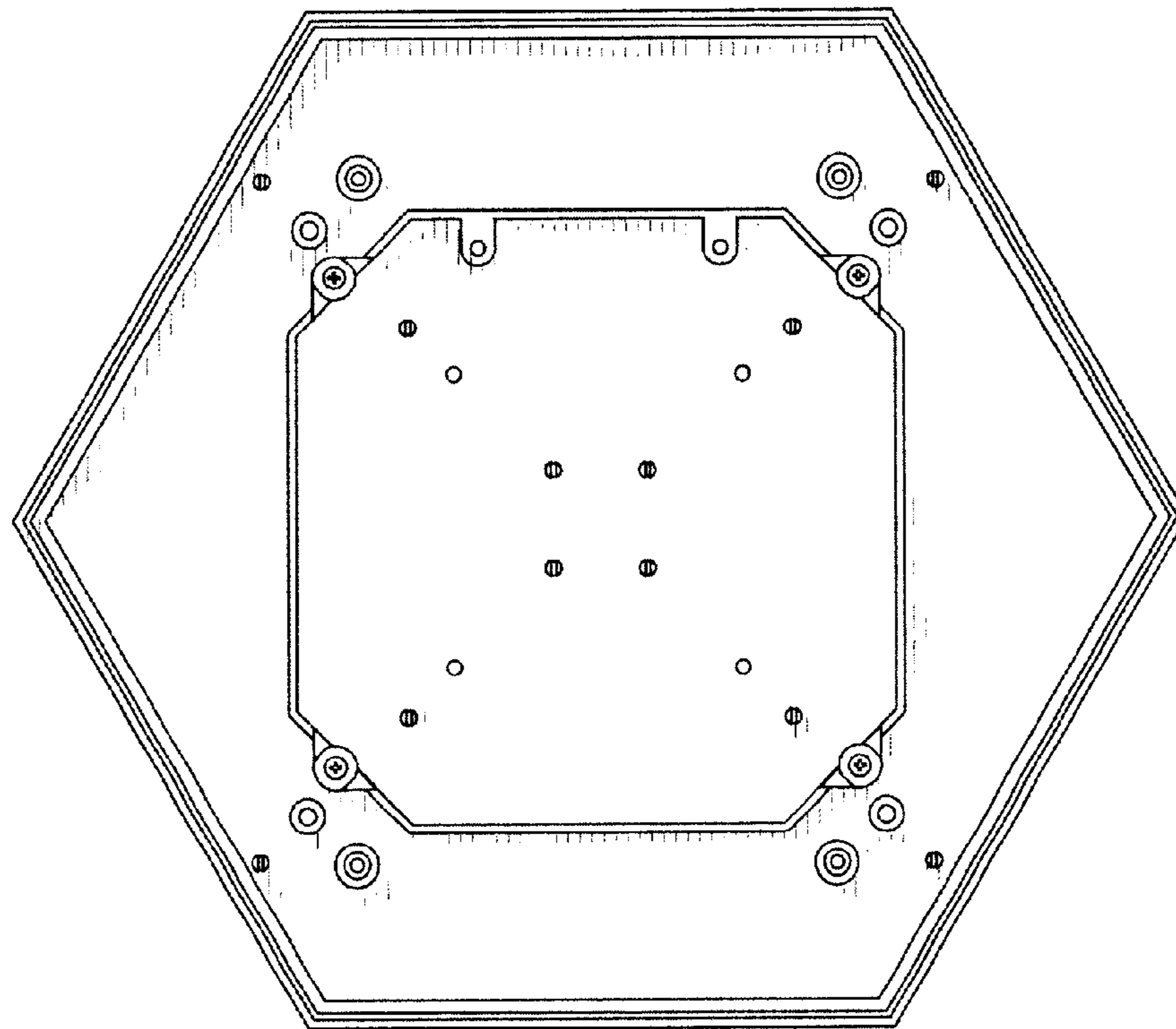

FIG. 7

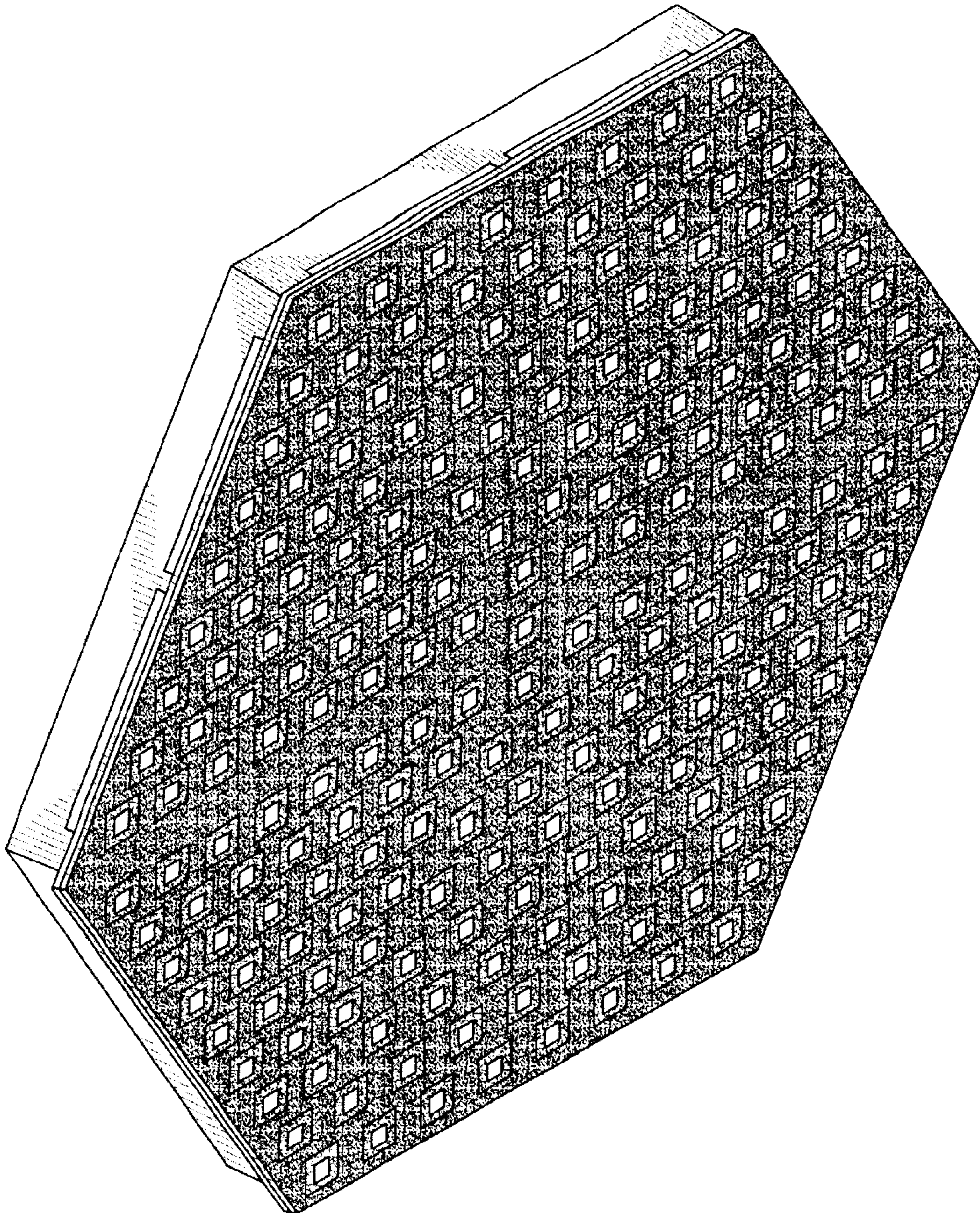

FIG. 8