



US00D526336S

(12) **United States Design Patent**
Maas et al.

(10) **Patent No.:** **US D526,336 S**

(45) **Date of Patent:** **** Aug. 8, 2006**

(54) **REAR PANEL FOR A COMBINE**

(75) Inventors: **Brian Joseph Maas**, Bettendorf, IA
(US); **Bengt Ake Nestell**, Pottstown, PA
(US); **Ronald John Moron**, Milan, IL
(US)

(73) Assignee: **Deere & Company**, Moline, IL (US)

(**) Term: **14 Years**

(21) Appl. No.: **29/234,334**

(22) Filed: **Jul. 15, 2005**

(51) **LOC (8) Cl.** **15-03**

(52) **U.S. Cl.** **D15/28; D15/10**

(58) **Field of Classification Search** D15/10,
D15/12, 14-18, 23, 27, 28, 33, 25, 26; D12/1,
D12/196, 218; 56/14.5, 14.6, 122-125; 296/2,
296/191, 139.7

See application file for complete search history.

(56) **References Cited**

U.S. PATENT DOCUMENTS

D188,206 S	*	6/1960	Klemm	D15/26
D221,573 S		8/1971	Ashton	D40/1
D256,801 S		9/1980	Skyer et al.	D15/23
4,241,566 A		12/1980	Webster	56/14.6
4,266,393 A		5/1981	Taylor	56/14.6
D309,738 S		8/1990	Schober et al.	D15/26
5,156,570 A		10/1992	Justice, III	460/118

D399,851 S		10/1998	Stauffer et al.	D15/10
D400,543 S	*	11/1998	Benedict et al.	D15/10
6,095,594 A		8/2000	Ridale et al.	296/191
D432,142 S		10/2000	Olson et al.	D15/10
D432,143 S		10/2000	Olson et al.	D15/10
D436,363 S	*	1/2001	Strong et al.	D15/10
D438,217 S		2/2001	Olson et al.	D15/10
D460,461 S	*	7/2002	Strong et al.	D15/10

* cited by examiner

Primary Examiner—Stella Reid

Assistant Examiner—Mark Goodwin

(57) **CLAIM**

The ornamental design for a rear panel for a combine, as shown and described.

DESCRIPTION

FIG. 1 is a left rear perspective view of a combine rear panel showing our new design.

FIG. 2 is a rear view of the combine rear panel design of FIG. 1.

FIG. 3 is a left side view of the combine rear panel design of FIG. 1.

FIG. 4 is a right side view of the combine rear panel design of FIG. 1.

FIG. 5 is a top view of the combine rear panel design of FIG. 1; and,

FIG. 6 is a bottom view of the combine rear panel design of FIG. 1.

1 Claim, 4 Drawing Sheets

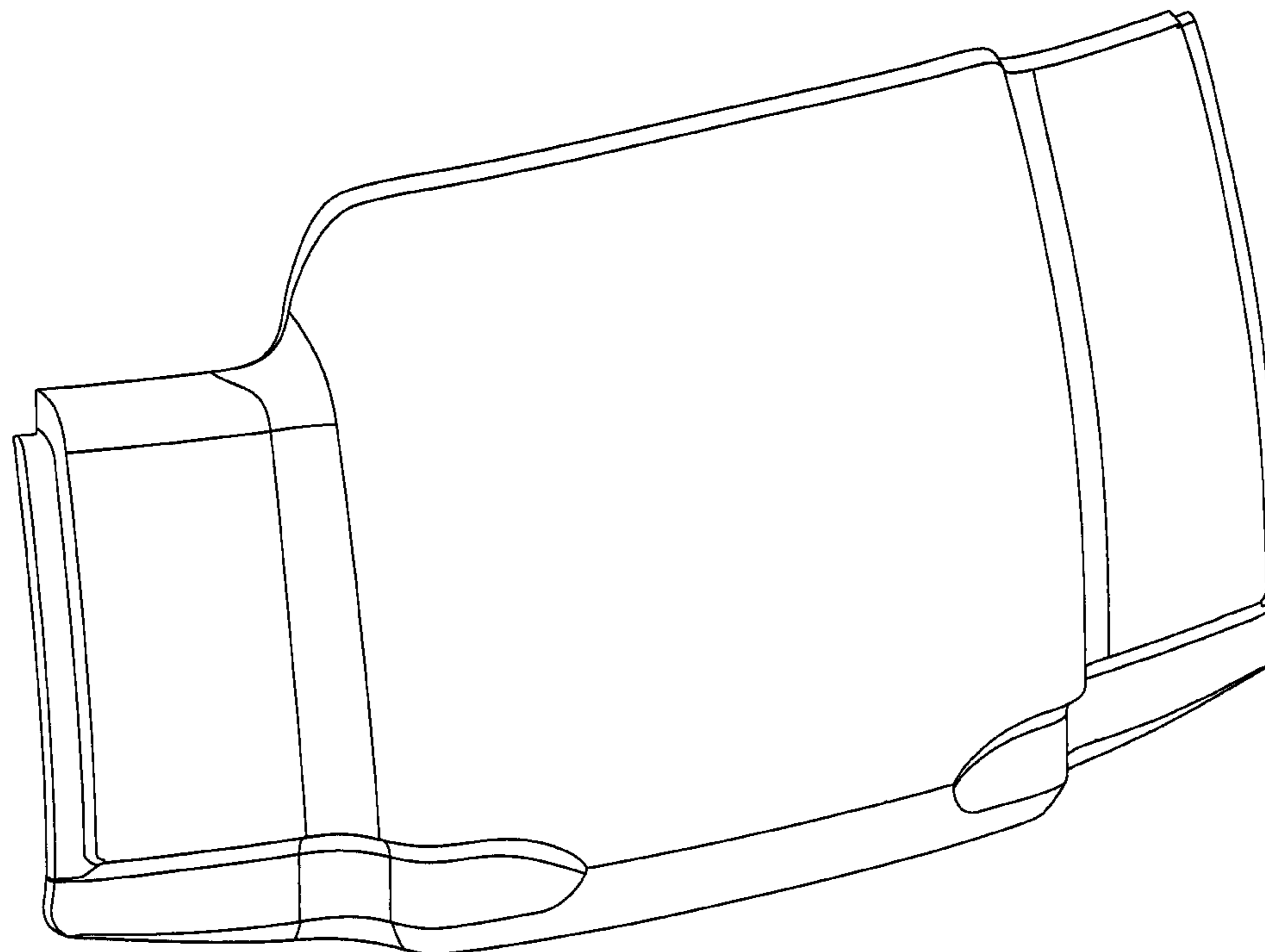

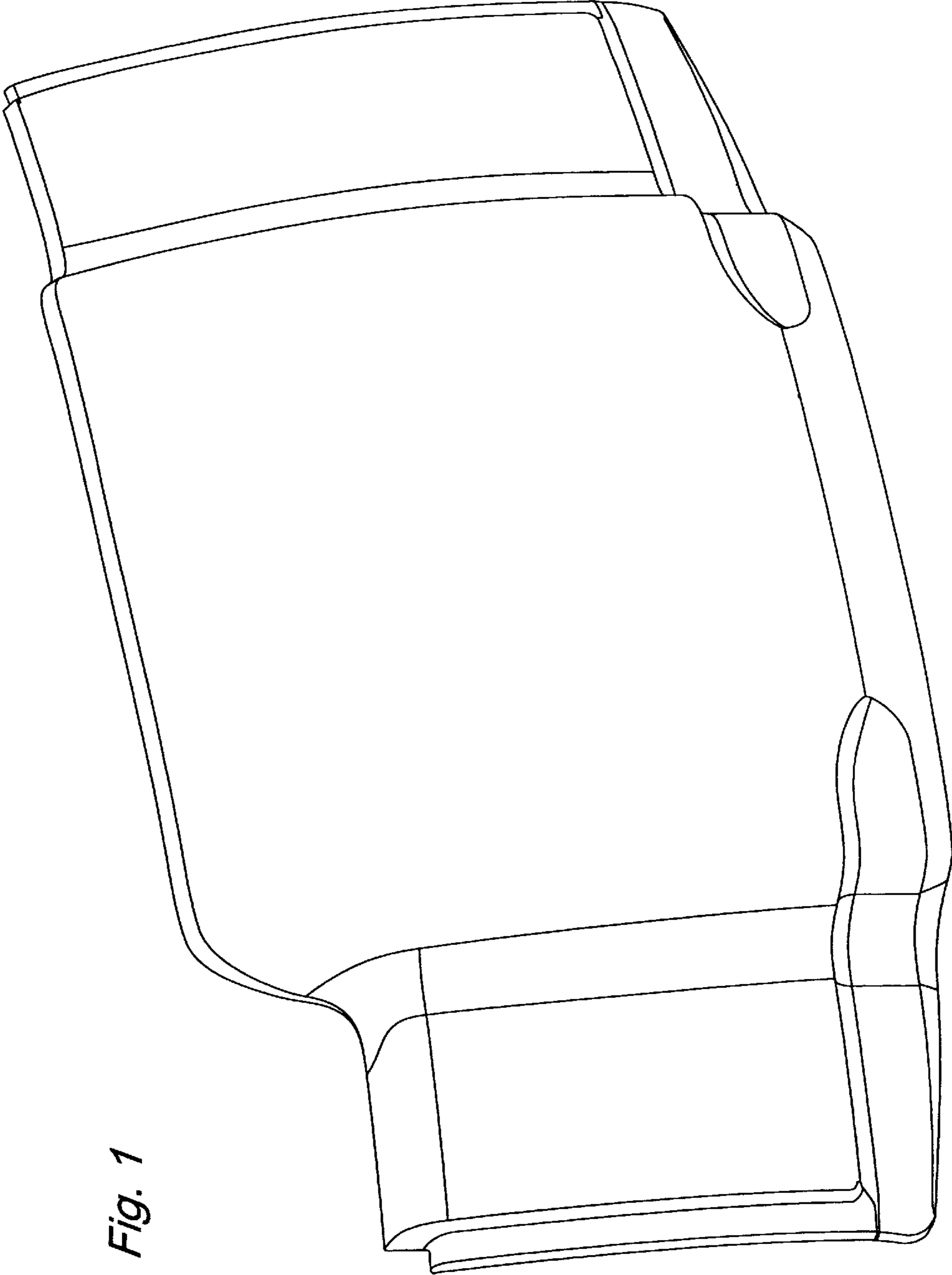

Fig. 1

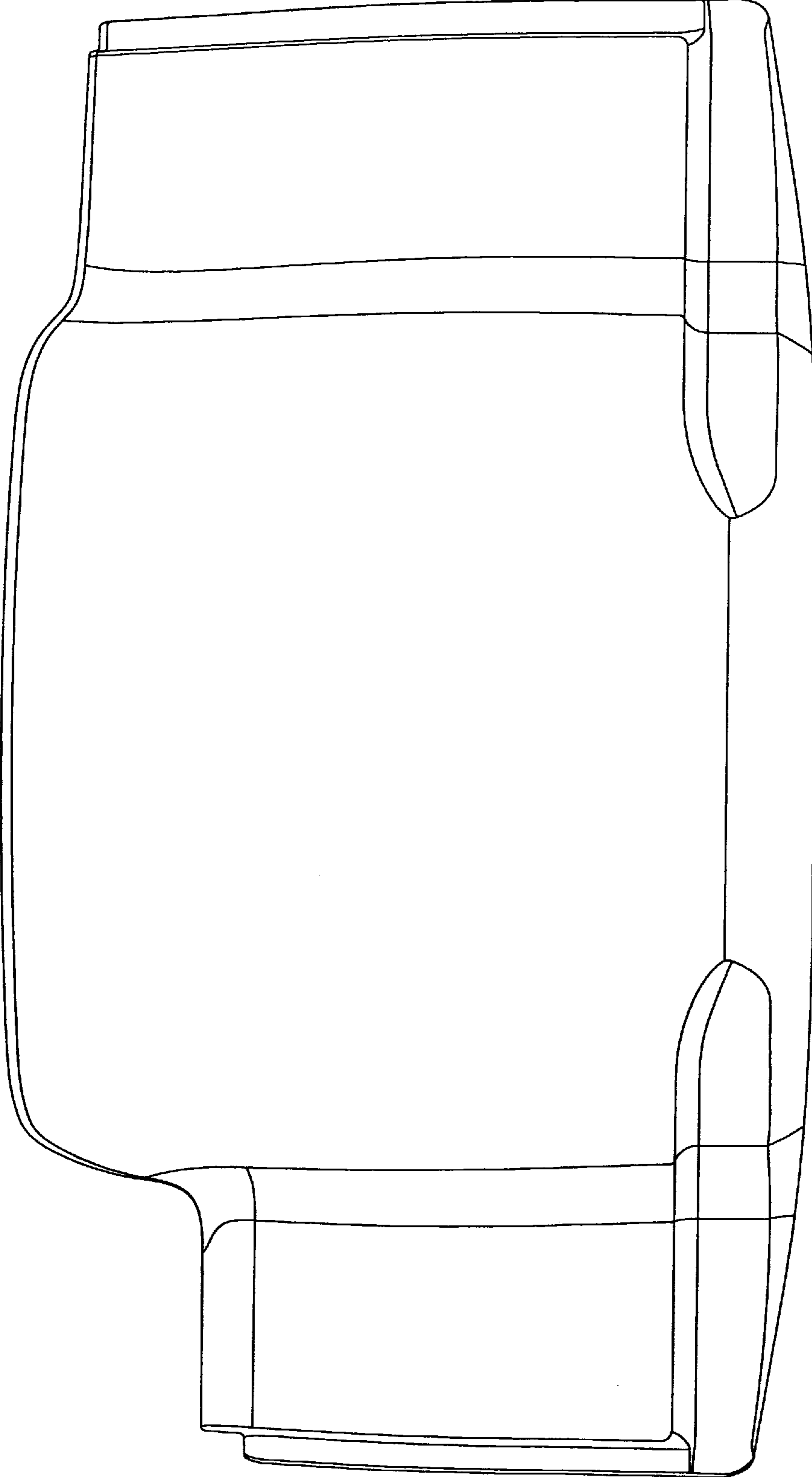

Fig. 2

Fig. 4

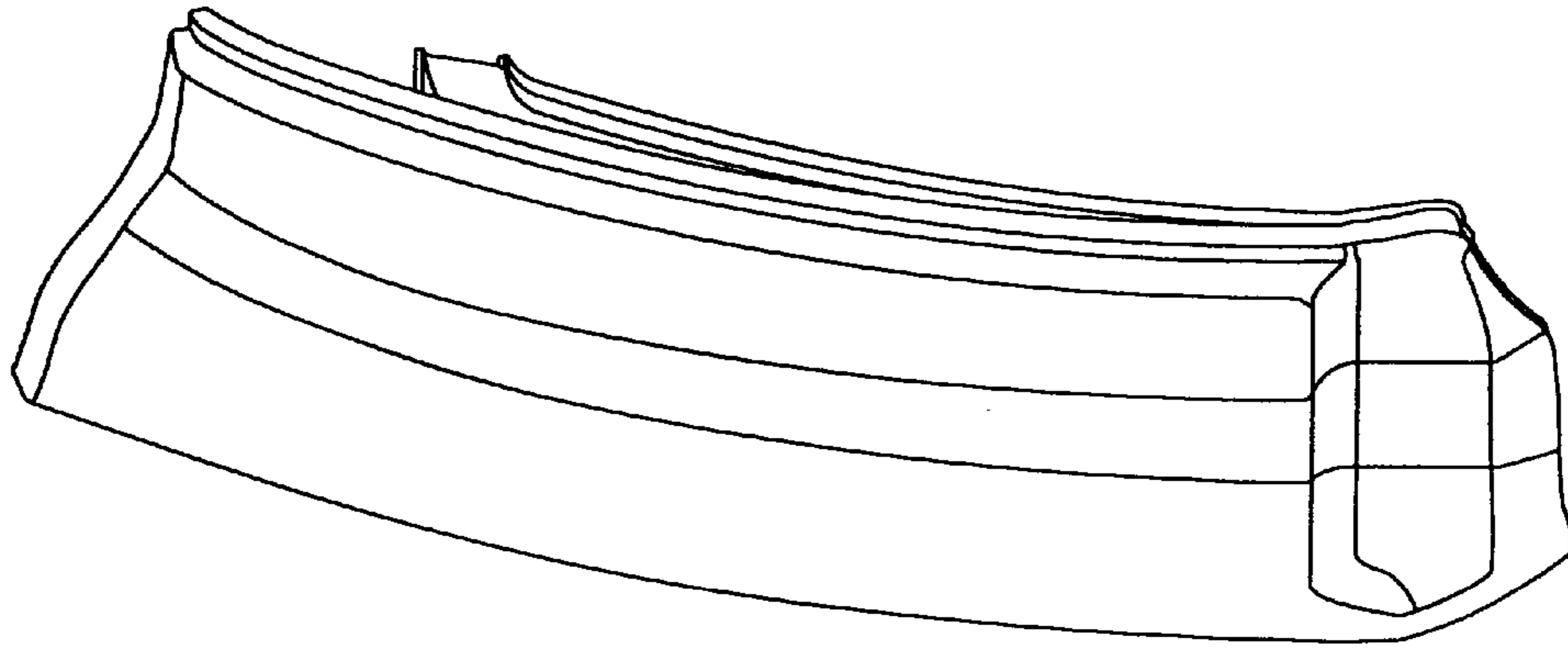
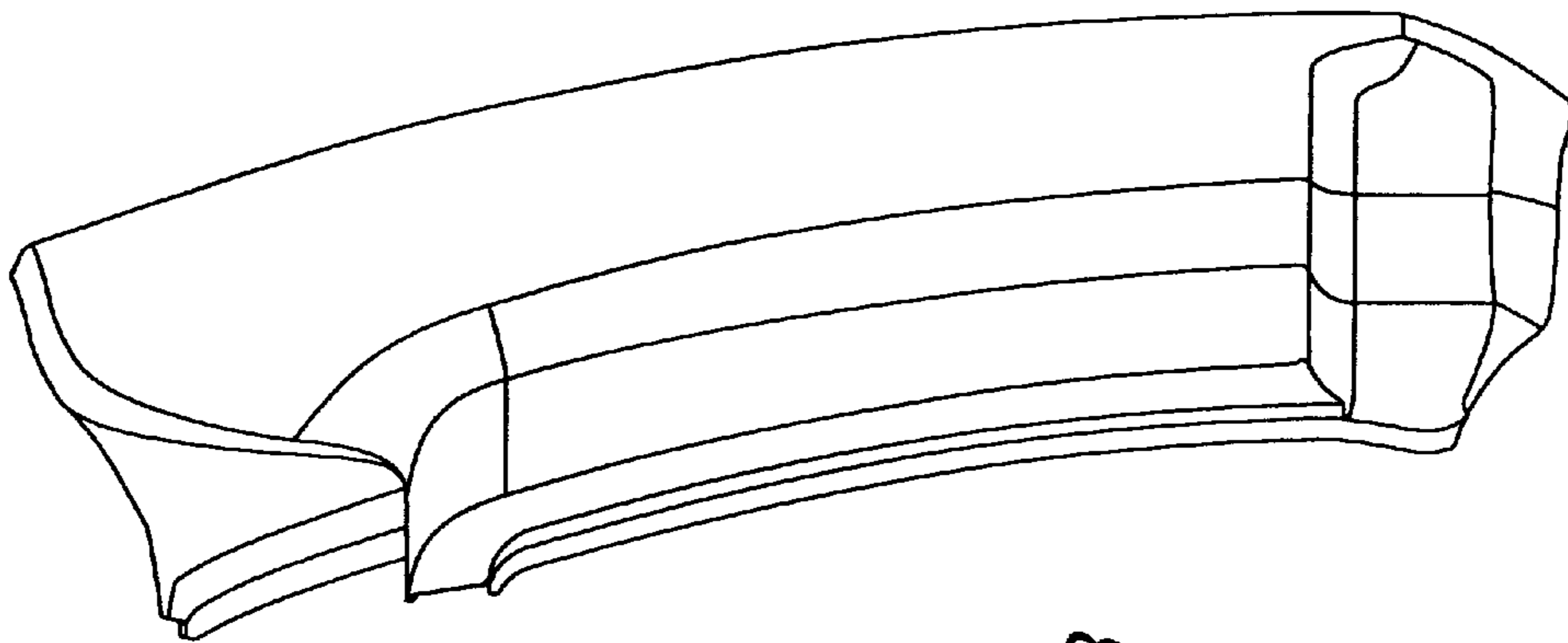

Fig. 3



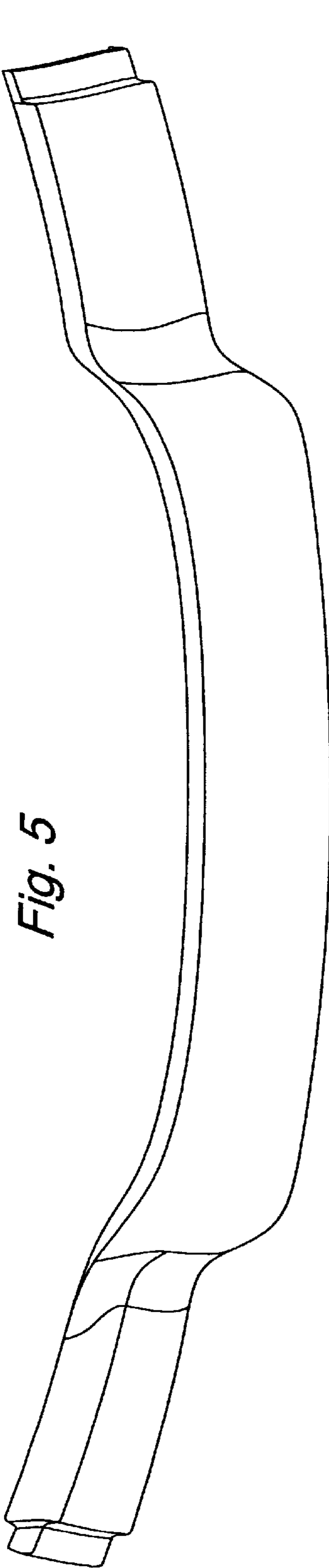

Fig. 5

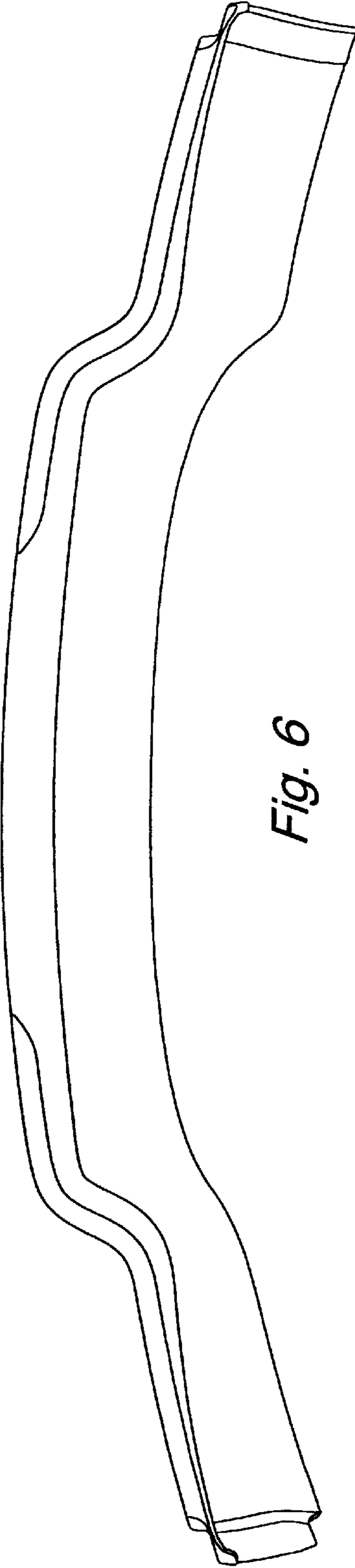

Fig. 6