

US00D526289S

(12) **United States Design Patent**  
**Hoehn et al.**

(10) **Patent No.:** **US D526,289 S**  
(45) **Date of Patent:** **\*\* Aug. 8, 2006**

(54) **TELEVISION SET**

(75) Inventors: **Holger Hoehn**, Taipei (TW); **Reinier Bloem**, Taipei (TW)

(73) Assignee: **Hannspree, Inc.**, Taipei (TW)

(\*\*) Term: **14 Years**

(21) Appl. No.: **29/237,135**

(22) Filed: **Aug. 29, 2005**

(30) **Foreign Application Priority Data**

Mar. 25, 2005 (TW) ..... 94301664

(51) **LOC (8) Cl.** ..... **14-03**

(52) **U.S. Cl.** ..... **D14/126**

(58) **Field of Classification Search** ..... D14/125-134,  
D14/239, 371, 136, 374-377; 312/7.2; 348/836,  
348/838, 180, 184, 325, 739; 341/12; 248/917-924,  
248/465; 345/104, 133, 156, 168, 87, 173;  
720/605, 669, 600, 655; 369/99, 197; 455/344-347  
See application file for complete search history.

(56) **References Cited**

**U.S. PATENT DOCUMENTS**

D347,246 S \* 5/1994 Wen ..... D21/329  
D397,729 S \* 9/1998 Schulz et al. .... D21/324

D399,268 S \* 10/1998 Liu ..... D21/333  
D406,613 S \* 3/1999 Nakanishi ..... D21/329  
D427,529 S \* 7/2000 Haney ..... D10/2  
6,227,966 B1 \* 5/2001 Yokoi ..... 463/1  
D474,468 S \* 5/2003 Zuege et al. .... D14/374  
D475,707 S \* 6/2003 Zuege et al. .... D21/515  
D494,970 S \* 8/2004 Chen ..... D14/371  
D500,099 S \* 12/2004 Gioffre ..... D21/627  
6,937,464 B1 \* 8/2005 Adams et al. .... 361/681

\* cited by examiner

*Primary Examiner*—Raphael Barkai

(74) *Attorney, Agent, or Firm*—Troxell Law Office, PLLC

(57) **CLAIM**

The ornamental design for a television set, as shown and described.

**DESCRIPTION**

FIG. 1 is a perspective view of television set showing my design;  
FIG. 2 is front view thereof;  
FIG. 3 is a right side view thereof;  
FIG. 4 is a top view thereof;  
FIG. 5 is a bottom view thereof;  
FIG. 6 is a rear view thereof; and,  
FIG. 7 is a left side view thereof.

**1 Claim, 4 Drawing Sheets**

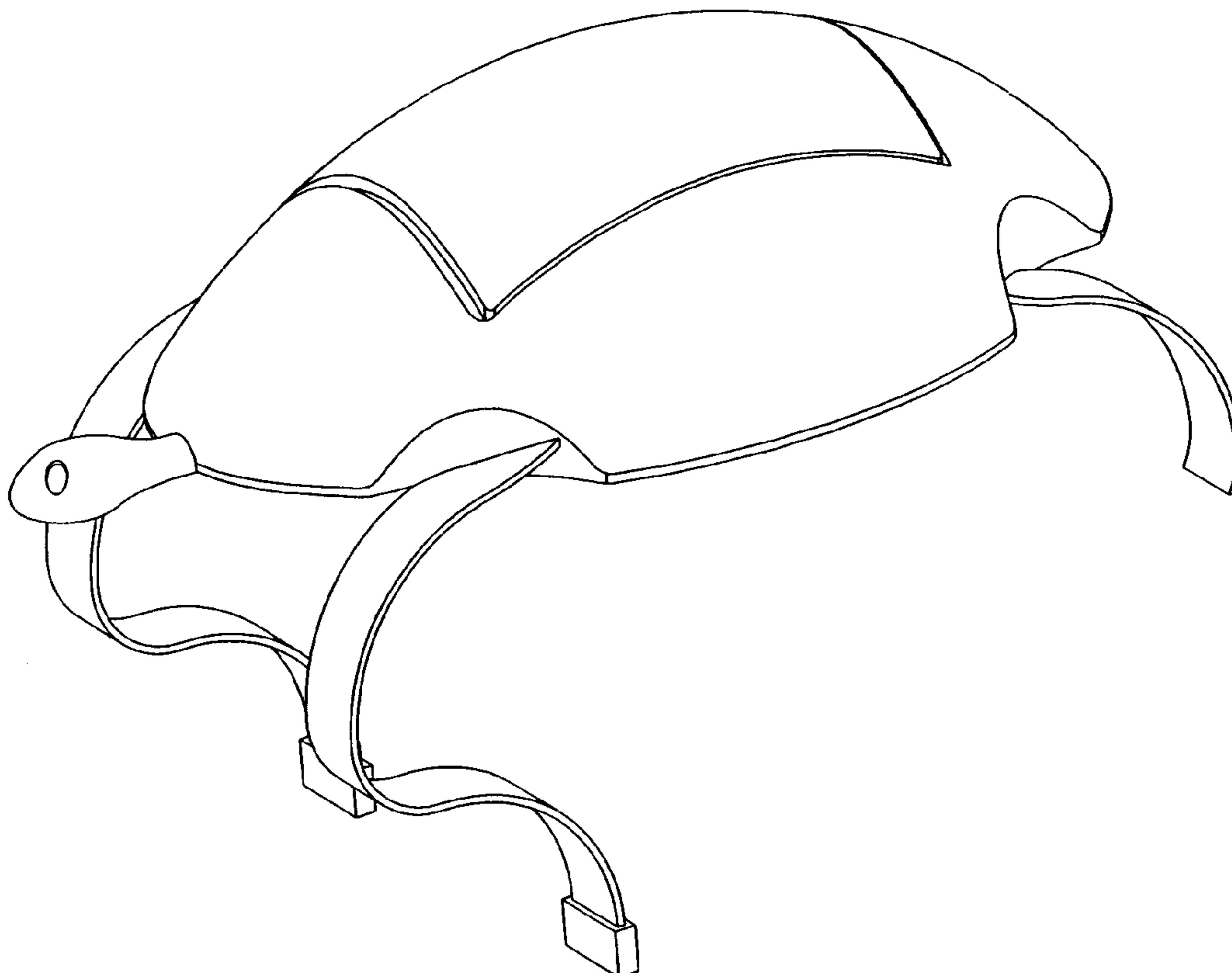

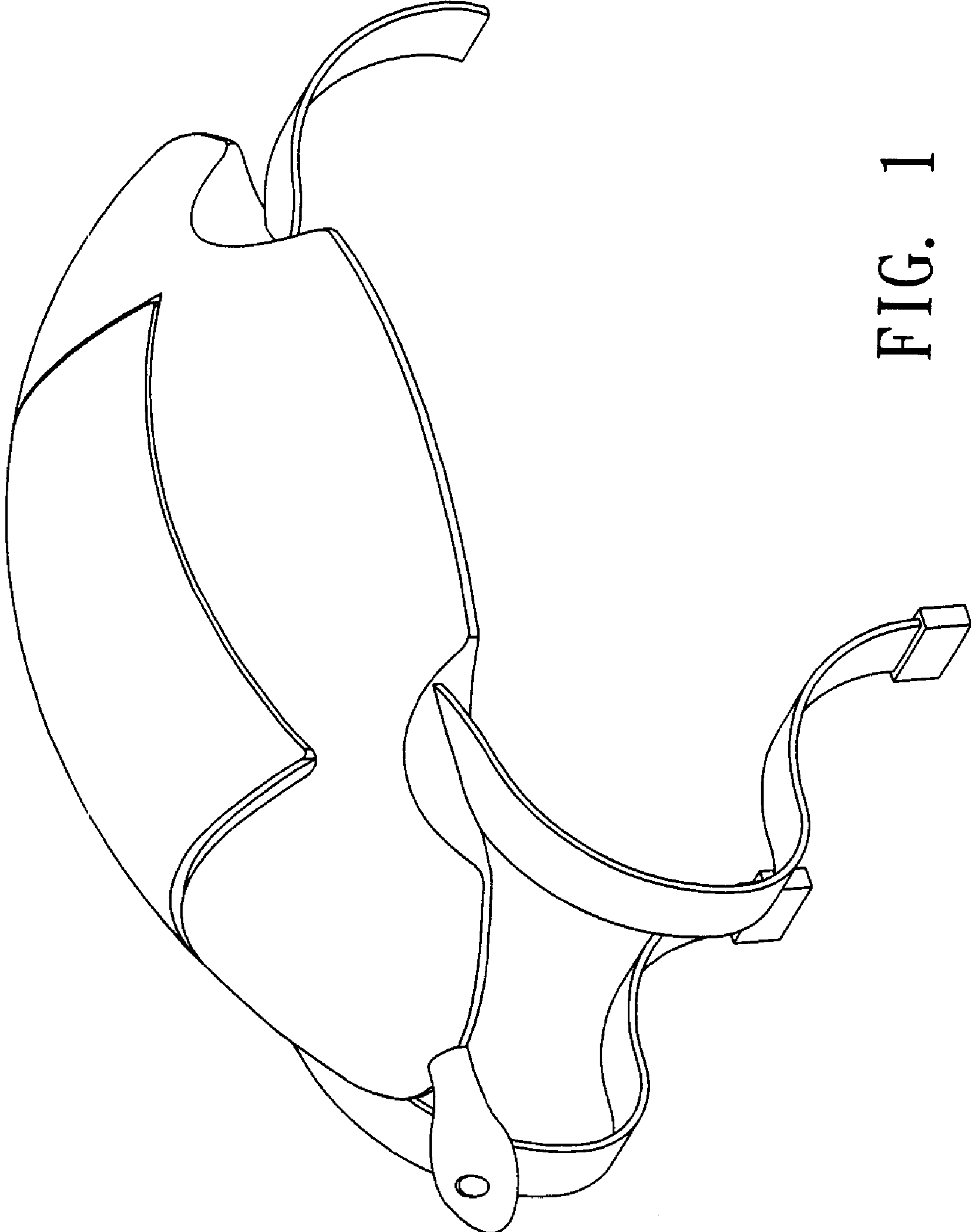

FIG. 1

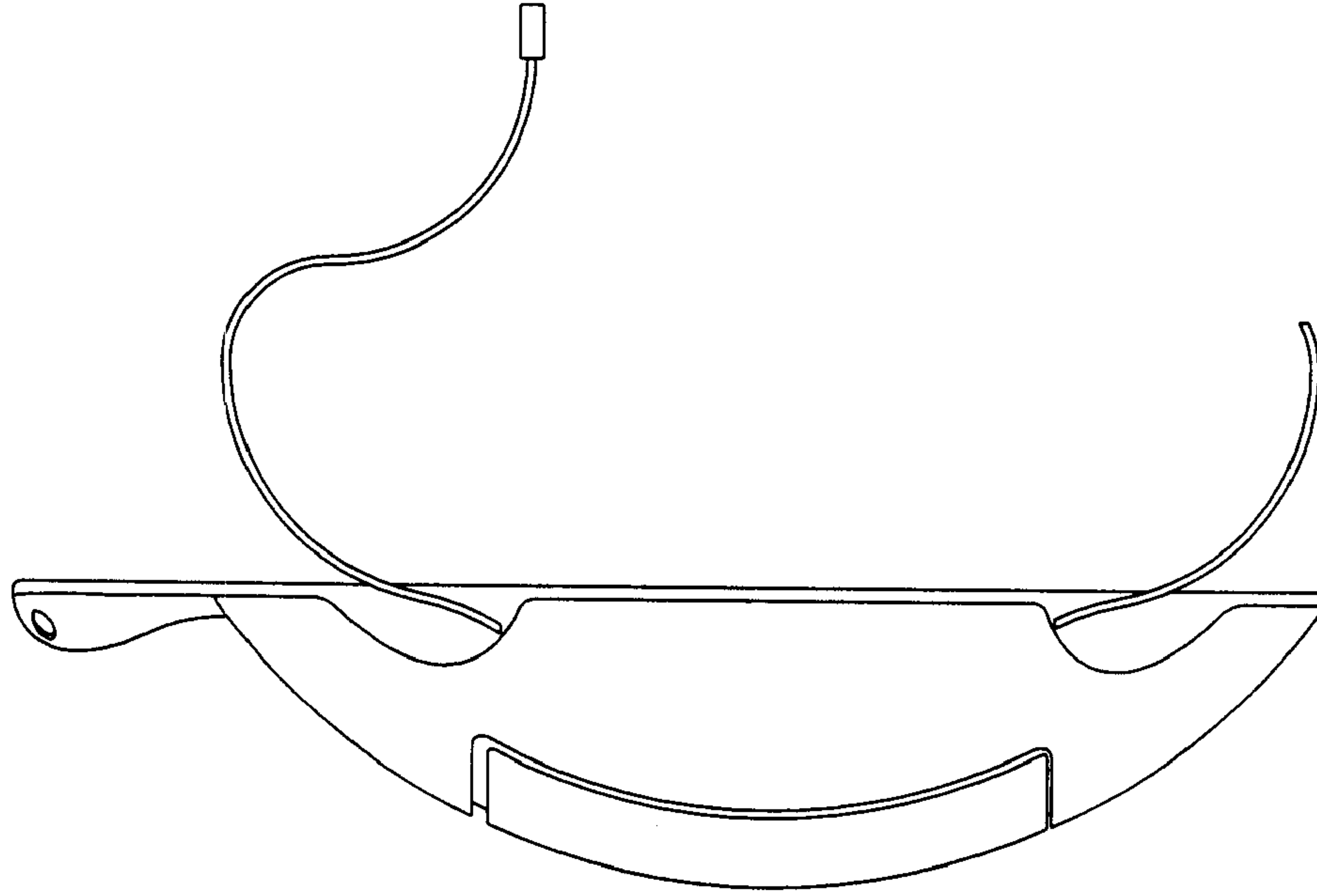

FIG. 3

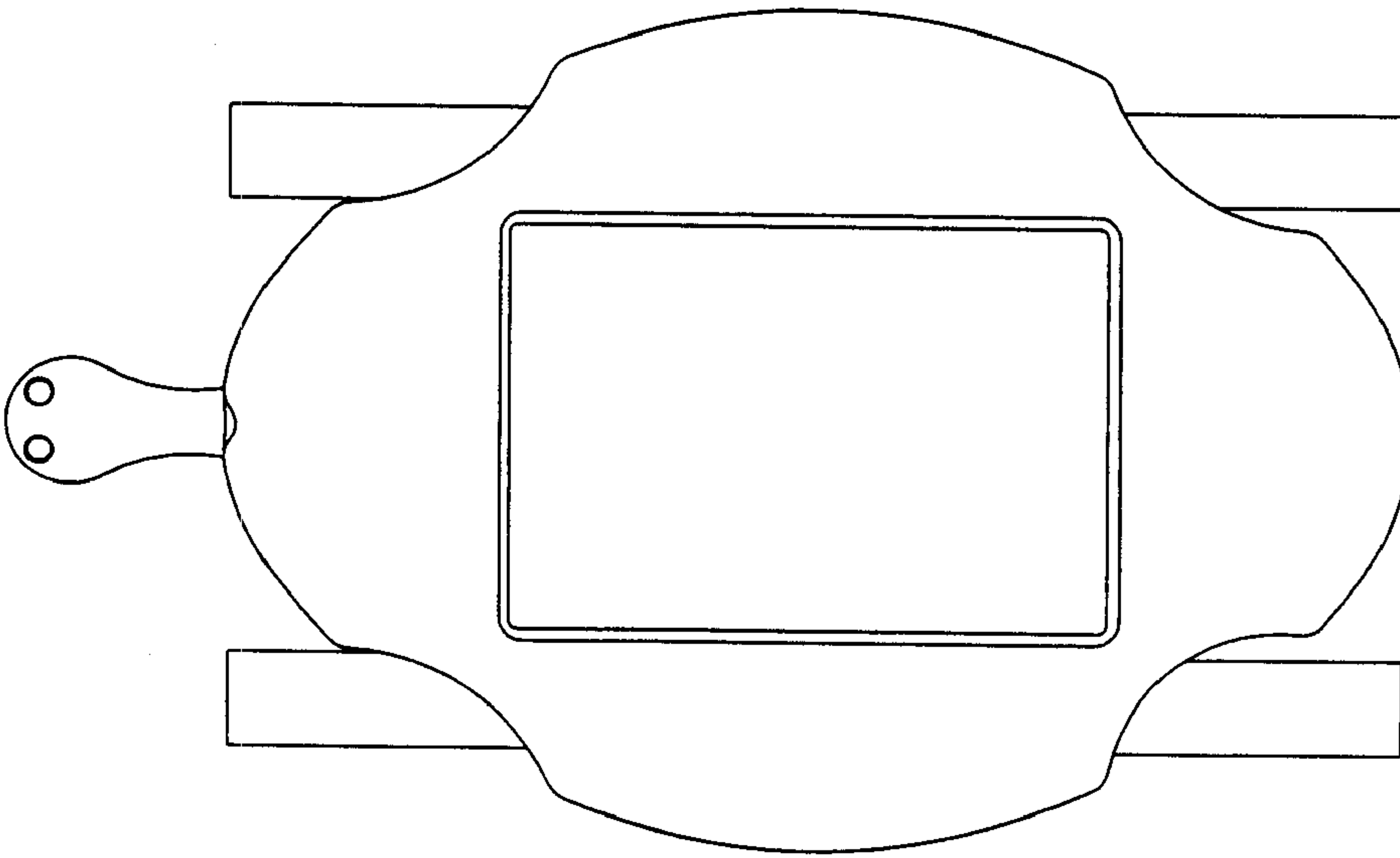

FIG. 2

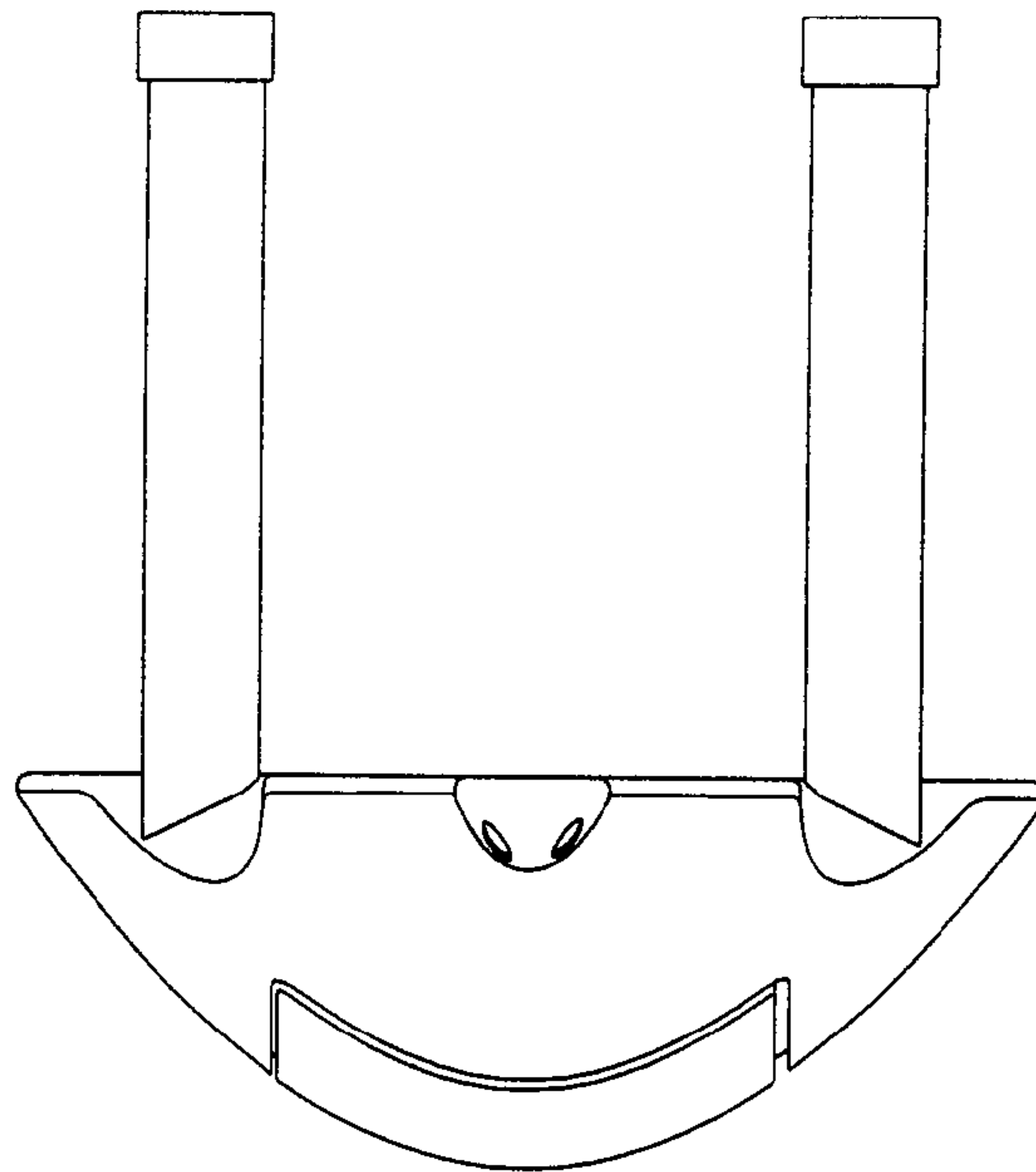

FIG. 4

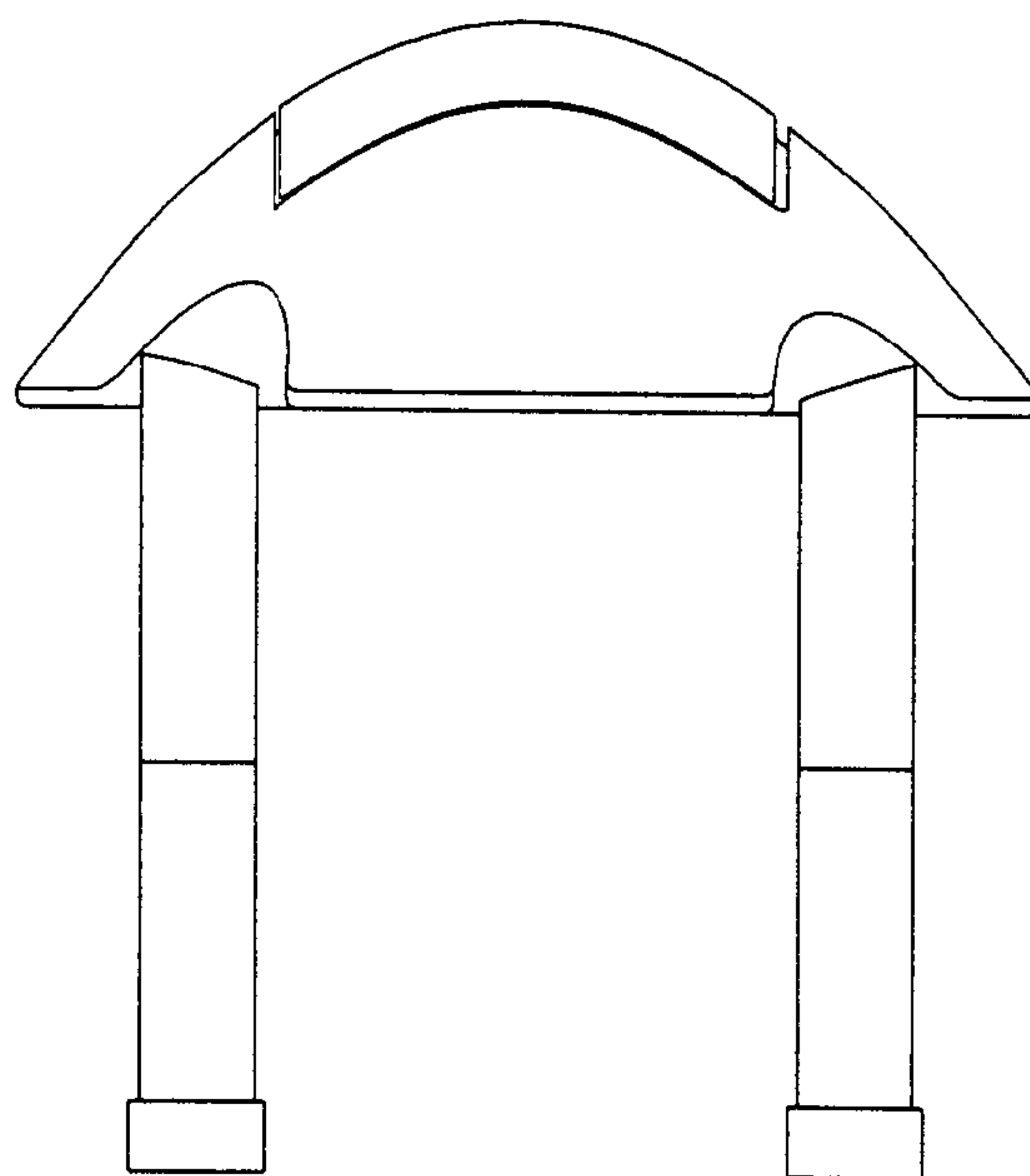

FIG. 5

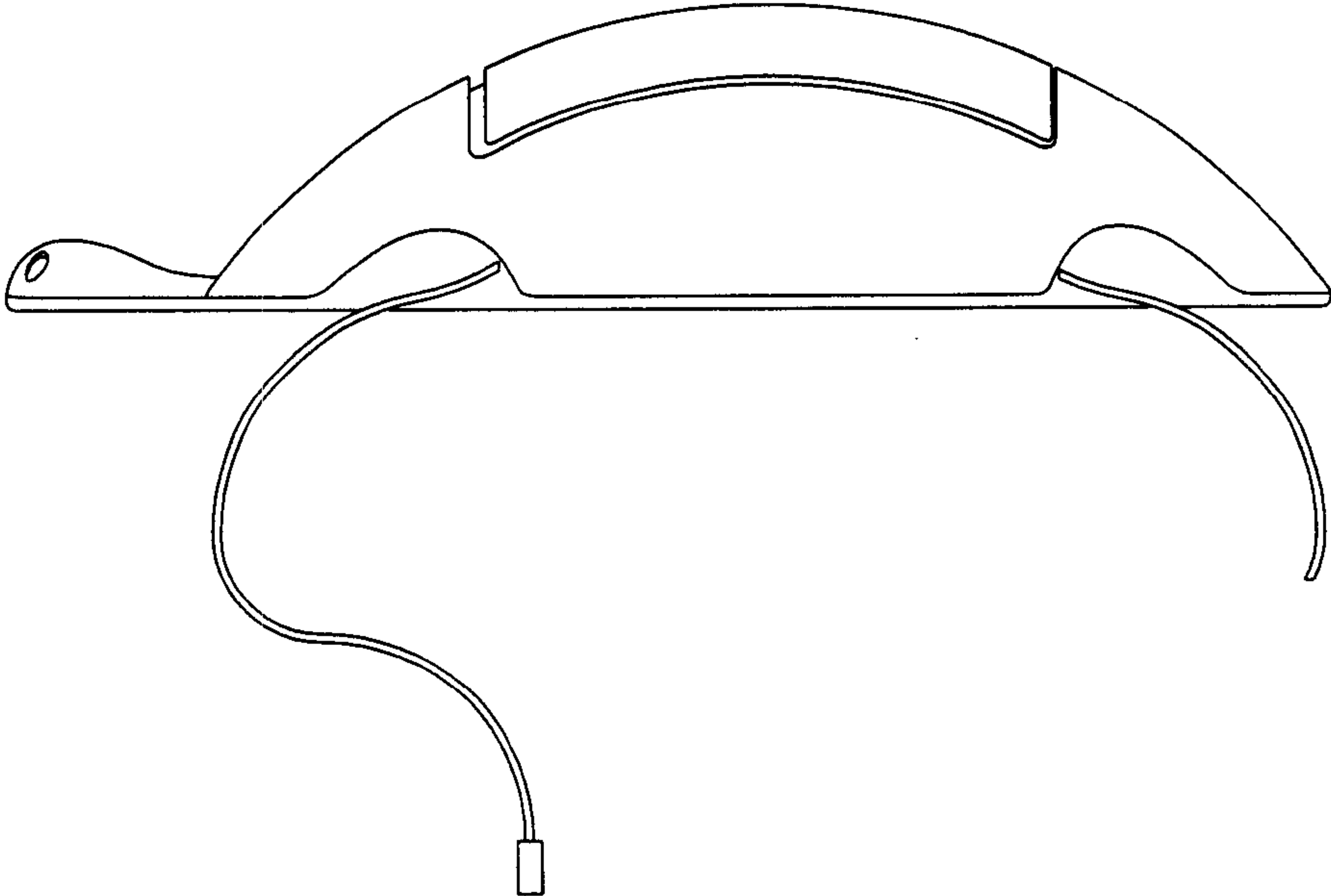

FIG. 7

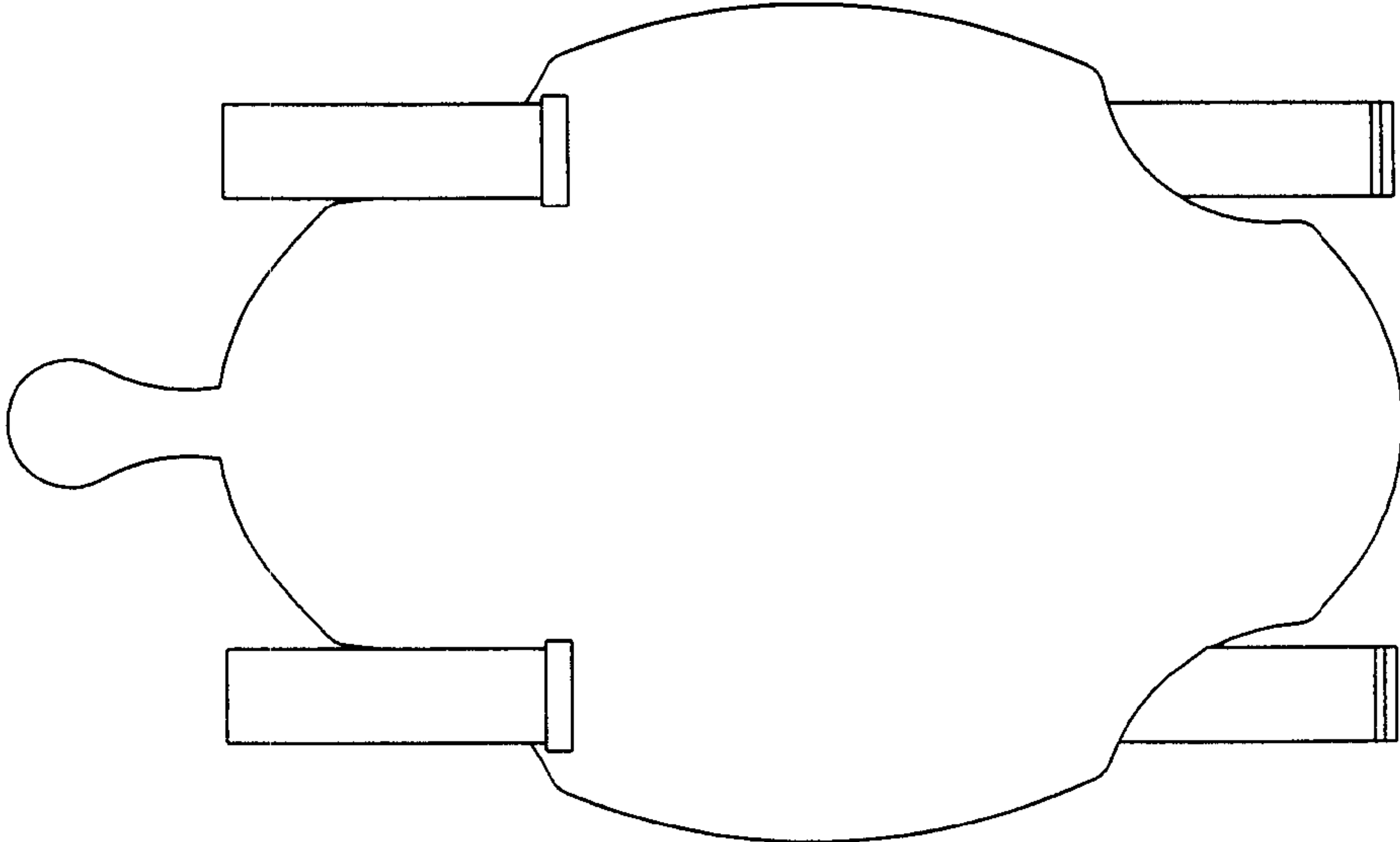

FIG. 6