



US00D526216S

(12) **United States Design Patent**  
**Tomimatsu**

(10) **Patent No.:** **US D526,216 S**

(45) **Date of Patent:** **\*\* Aug. 8, 2006**

(54) **WRIST WATCH**

(75) Inventor: **Daisuke Tomimatsu**, Tokyo (JP)

(73) Assignee: **Casio Keisanki Kabushiki Kaisha**,  
Tokyo (JP)

(\*\*) Term: **14 Years**

(21) Appl. No.: **29/232,130**

(22) Filed: **Jun. 15, 2005**

(51) **LOC (8) Cl.** ..... **10-02**

(52) **U.S. Cl.** ..... **D10/39**

(58) **Field of Classification Search** ..... D10/30-39,  
D10/122-132; 368/276, 281, 282, 285, 294,  
368/295, 316, 317, 21-27, 28-30, 82-84,  
368/226-228, 232, 250, 239-242, 10, 223,  
368/238

See application file for complete search history.

(56) **References Cited**

**U.S. PATENT DOCUMENTS**

D325,535 S	*	4/1992	Yamamoto	.....	D10/39
D327,445 S	*	6/1992	Fujihara	.....	D10/39
D327,656 S	*	7/1992	Sugita et al.	.....	D10/38
D355,613 S	*	2/1995	Takani et al.	.....	D10/39
D387,686 S	*	12/1997	Hanagata	.....	D10/38
D403,252 S	*	12/1998	Hanagata	.....	D10/38

D413,527 S	*	9/1999	Hanagata	.....	D10/30
D428,346 S	*	7/2000	Goto et al.	.....	D10/30
D430,043 S	*	8/2000	Schopfer	.....	D10/39
D441,302 S	*	5/2001	Tomimatsu	.....	D10/30
D447,065 S	*	8/2001	Baumann	.....	D10/39
D451,825 S	*	12/2001	Hanagata	.....	D10/30
D462,623 S	*	9/2002	Fujihara	.....	D10/30
D472,820 S	*	4/2003	Ditullo et al.	.....	D10/30
D488,389 S	*	4/2004	Moriai et al.	.....	D10/30
D504,830 S	*	5/2005	Sugisawa	.....	D10/39

\* cited by examiner

*Primary Examiner*—Lucy Lieberman

(74) *Attorney, Agent, or Firm*—Frishauf Holtz Goodman & Chick P.C.

(57) **CLAIM**

The ornamental design for a wrist watch, as shown.

**DESCRIPTION**

FIG. 1 is a reduced scale front, right side, bottom perspective view of a wrist watch showing my new design;  
FIG. 2 is a front elevational view thereof;  
FIG. 3 is a rear elevational view thereof;  
FIG. 4 is a left side view thereof;  
FIG. 5 is a right side view thereof;  
FIG. 6 is a top plan view thereof; and,  
FIG. 7 is a bottom plan view thereof.

**1 Claim, 6 Drawing Sheets**

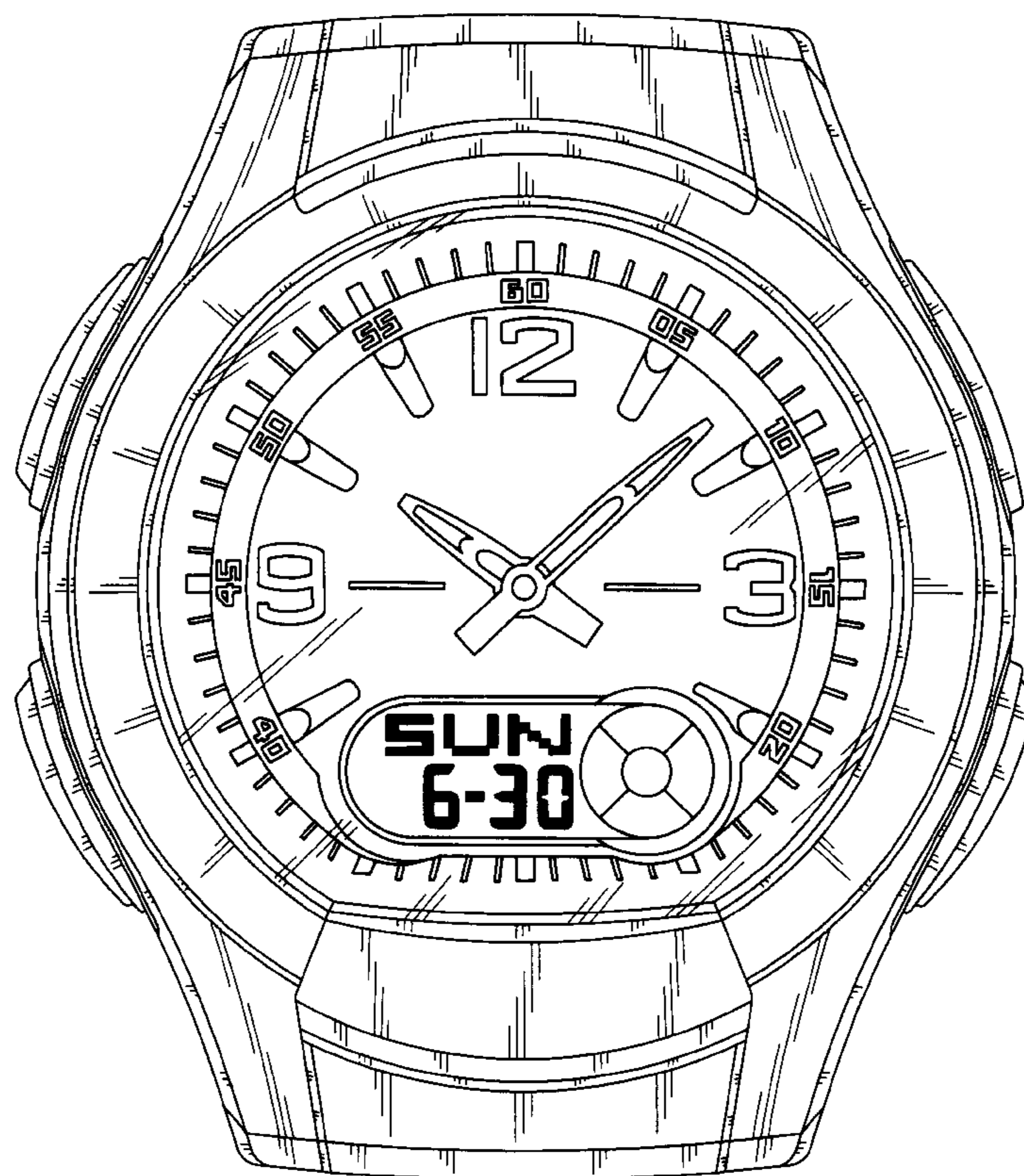

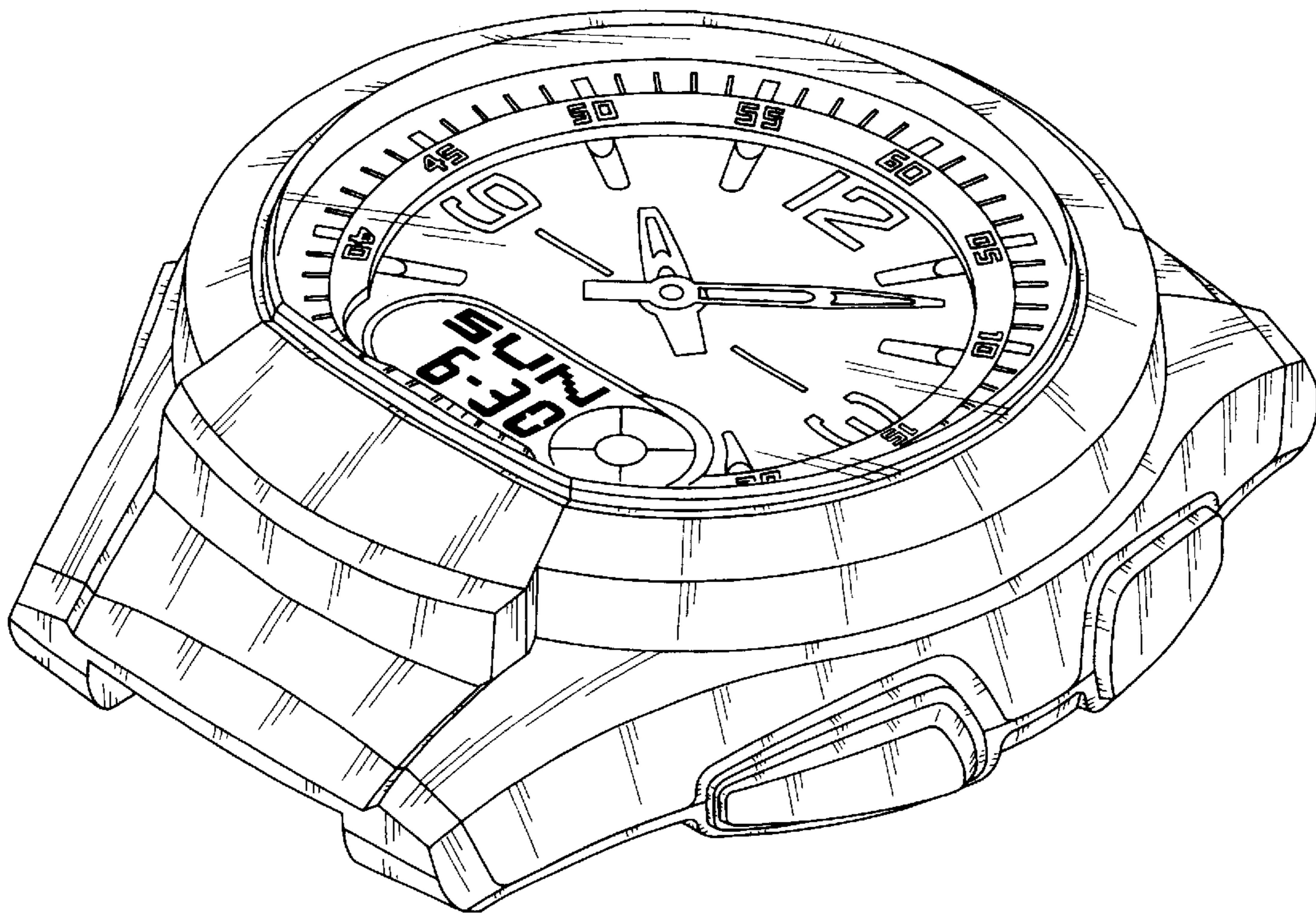

FIG. 1

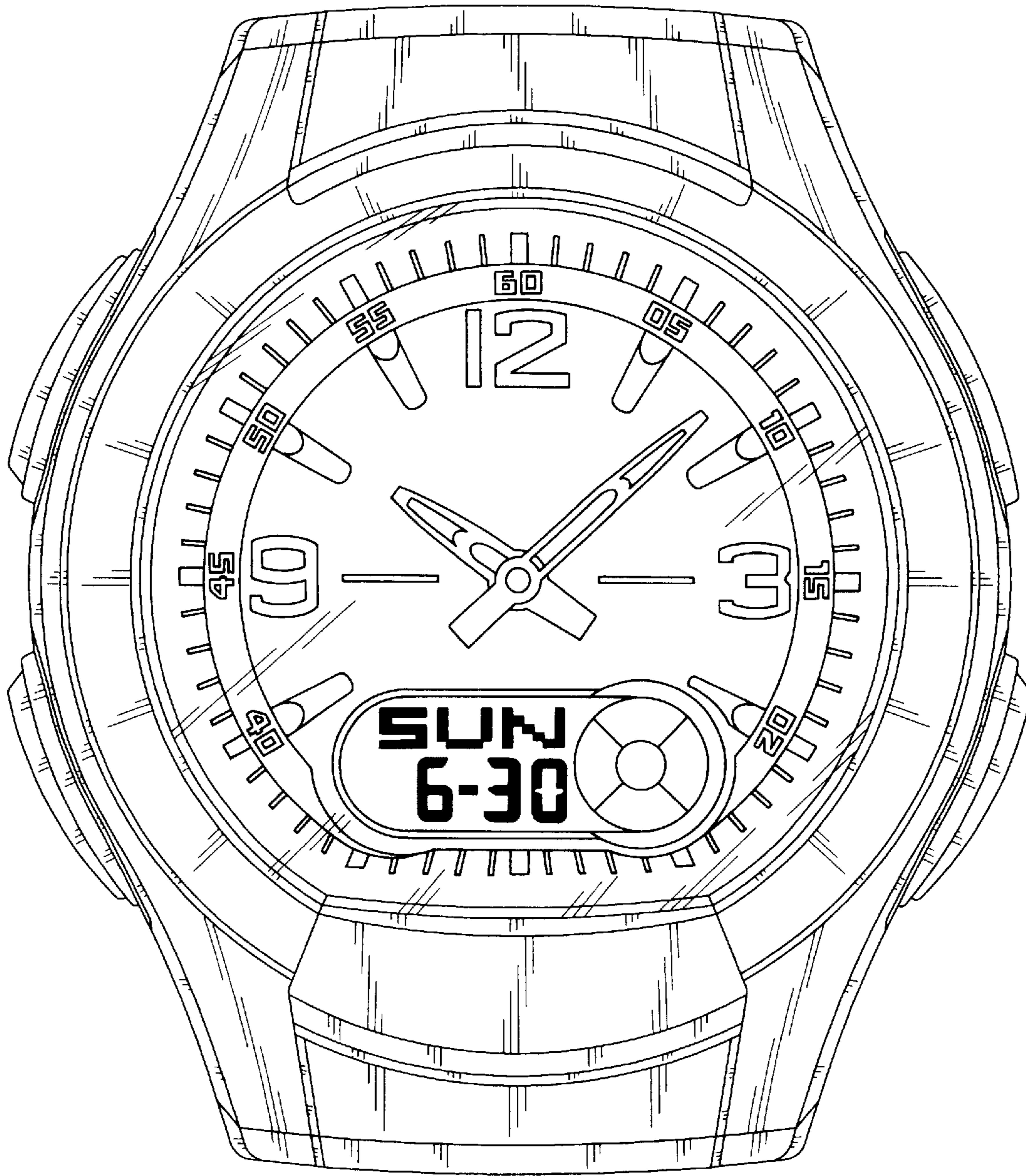

FIG. 2

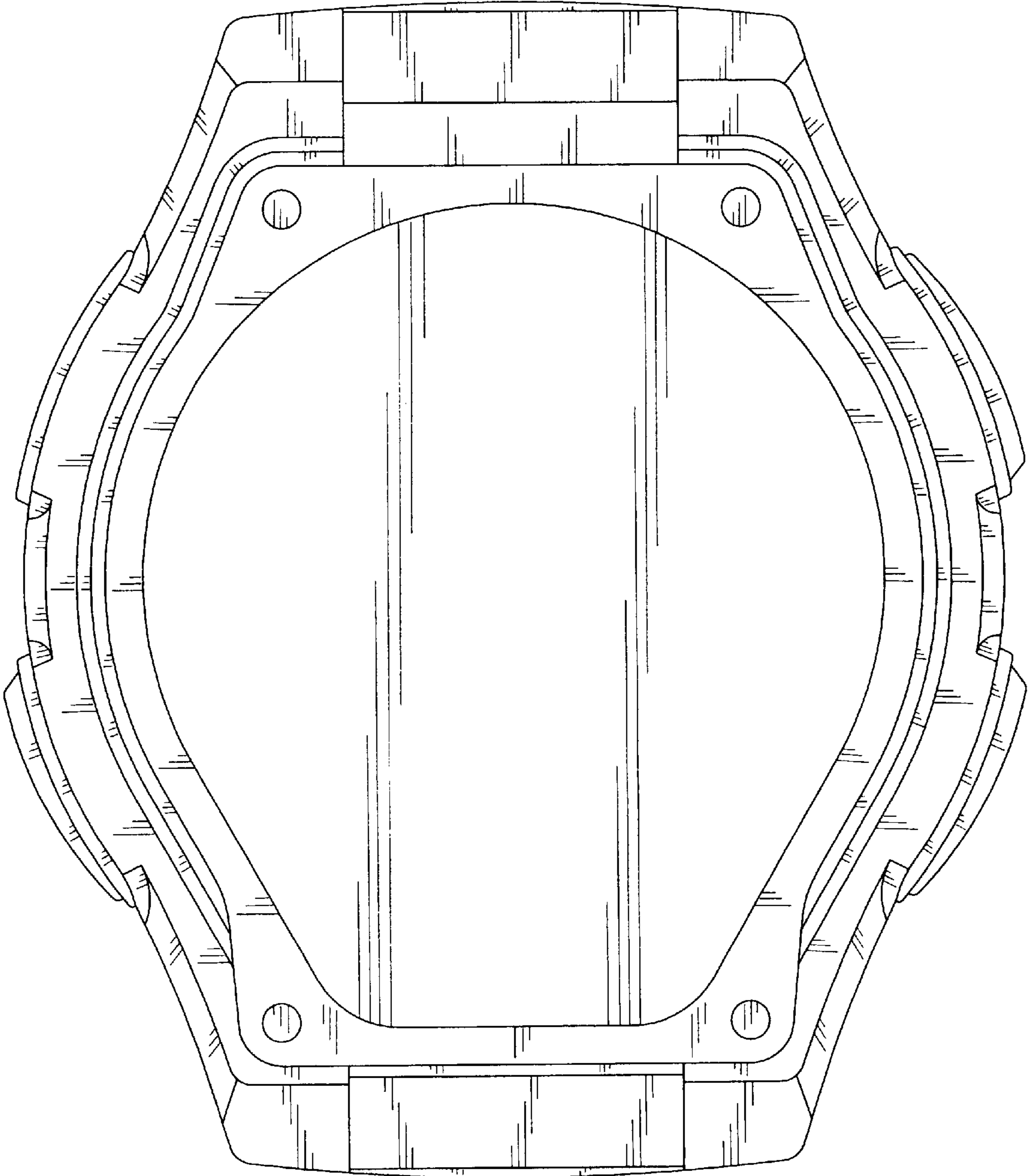

FIG. 3

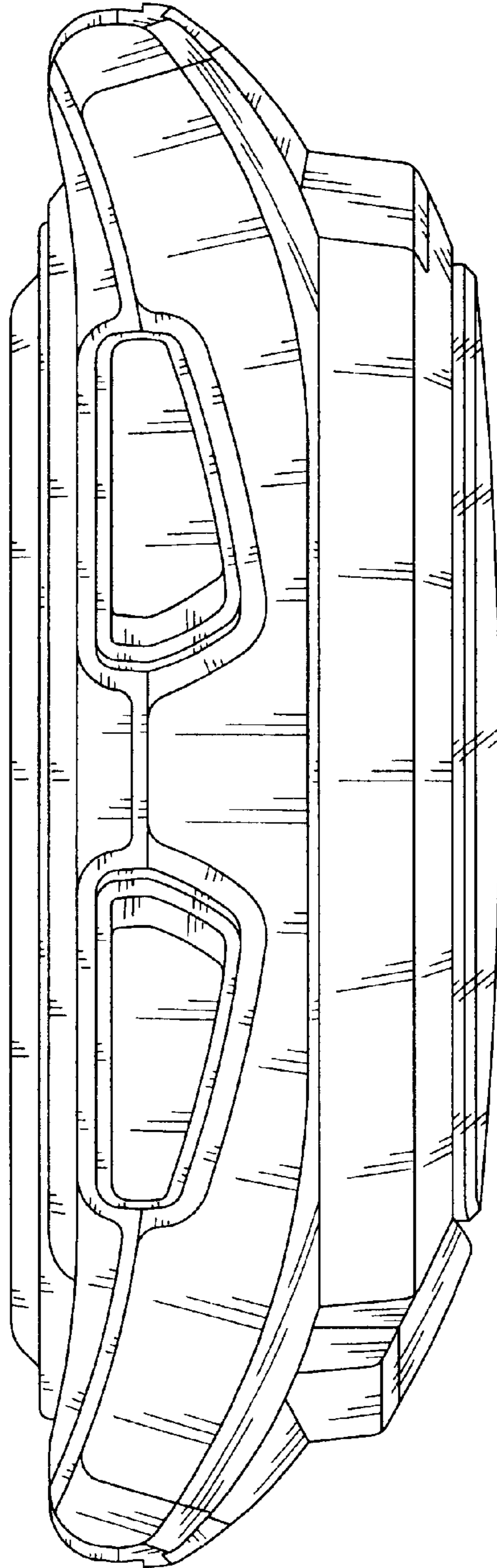

FIG. 4

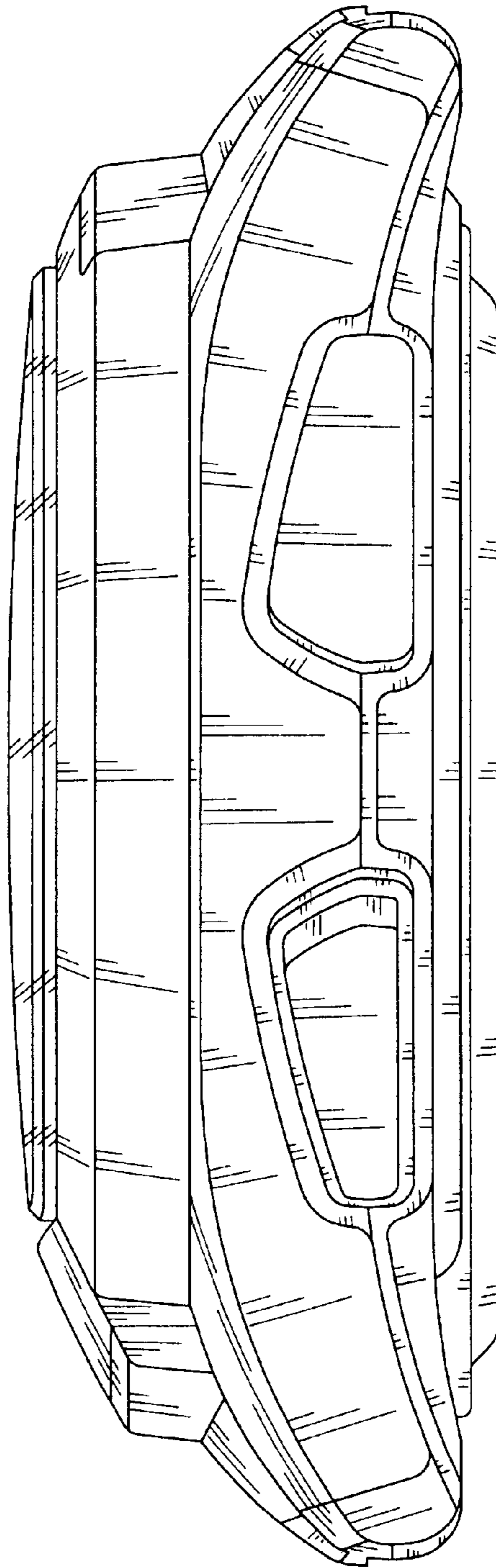

FIG. 5

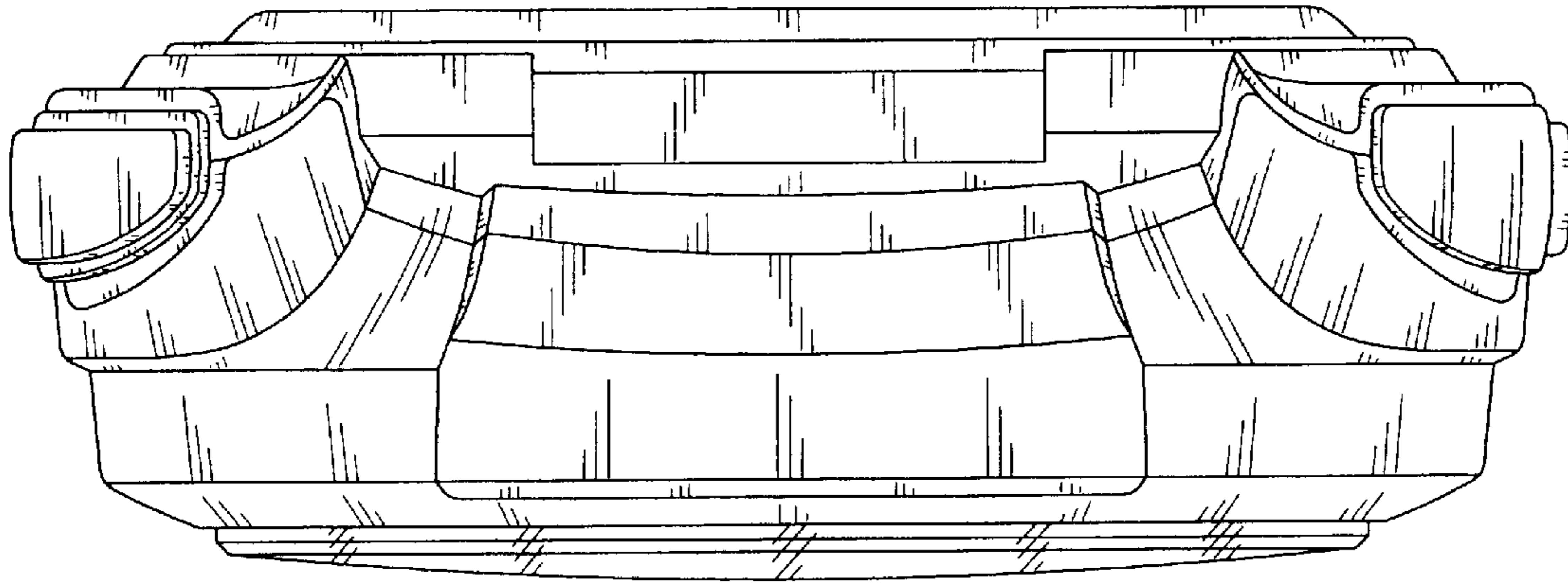

FIG. 6

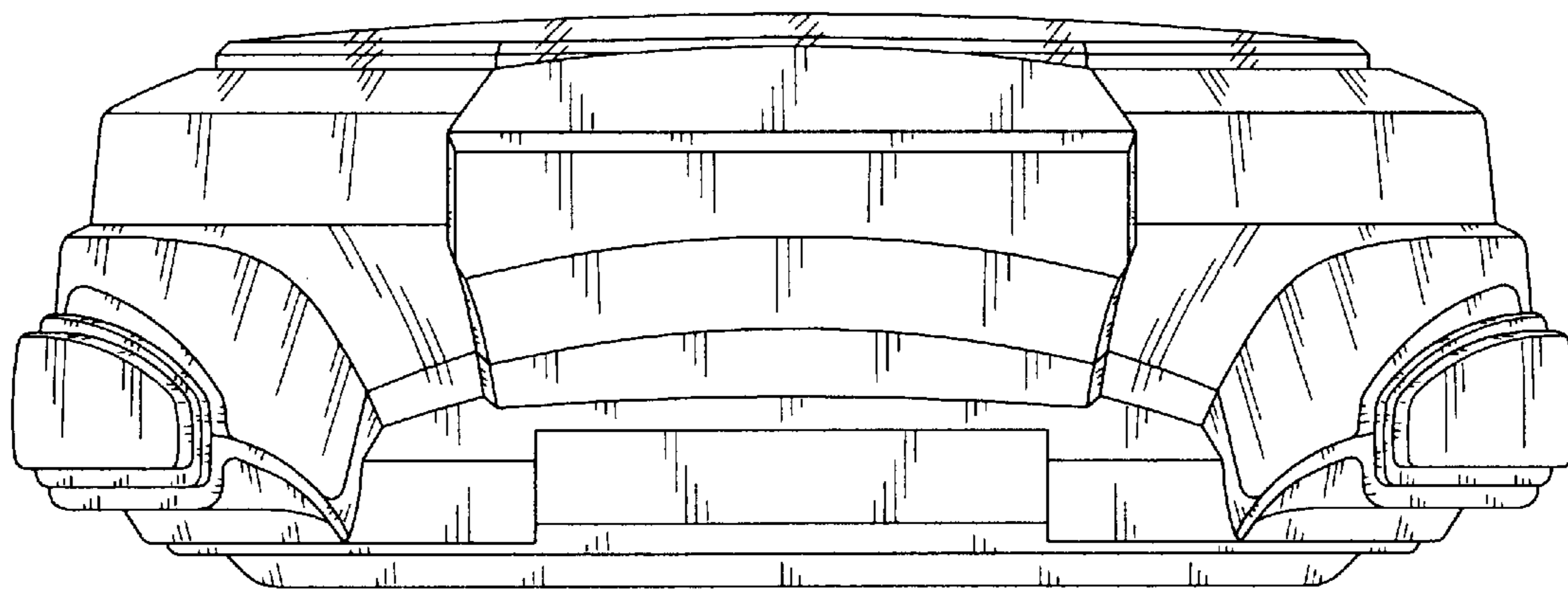

FIG. 7