



US00D525805S

(12) **United States Design Patent**
Nicoletti

(10) **Patent No.:** **US D525,805 S**

(45) **Date of Patent:** **** Aug. 1, 2006**

(54) **DESK**

(75) **Inventor:** **Bruno Nicoletti**, Calderino di Monte S. Pietro (IT)

(73) **Assignee:** **Metal Work Srl**, Bologna (IT)

(**) **Term:** **14 Years**

(21) **Appl. No.:** **29/210,659**

(22) **Filed:** **Aug. 4, 2004**

(51) **LOC (8) Cl.** **06-03**

(52) **U.S. Cl.** **D6/421**

(58) **Field of Classification Search** D6/421-428,
D6/332; 312/194-196, 208.1, 208.2, 238,
312/239; 108/50.01, 50.02, 60; 52/36.1, 239
See application file for complete search history.

(56) **References Cited**

U.S. PATENT DOCUMENTS

D223,838 S * 6/1972 Valle D6/423

D302,085 S * 7/1989 Tingley D6/421
5,848,497 A * 12/1998 Henderson 52/36.1
6,196,140 B1 * 3/2001 Newhouse et al. 108/50.01
6,805,060 B1 * 10/2004 Nicoletti 108/50.01

* cited by examiner

Primary Examiner—Janice E. Seeger

(74) *Attorney, Agent, or Firm*—William J. Sapone;
Coleman Sudol Sapone P.C.

(57) **CLAIM**

The design for a desk, as shown and described.

DESCRIPTION

FIG. 1 is a rear view of the desk, showing my new design;
FIG. 2 is a bottom view of the desk;
FIG. 3 is a front view the desk;
FIG. 4 is a left side view of the desk;
FIG. 5 is a right side view of the desk; and,
FIG. 6 is a top view of the desk.

1 Claim, 6 Drawing Sheets

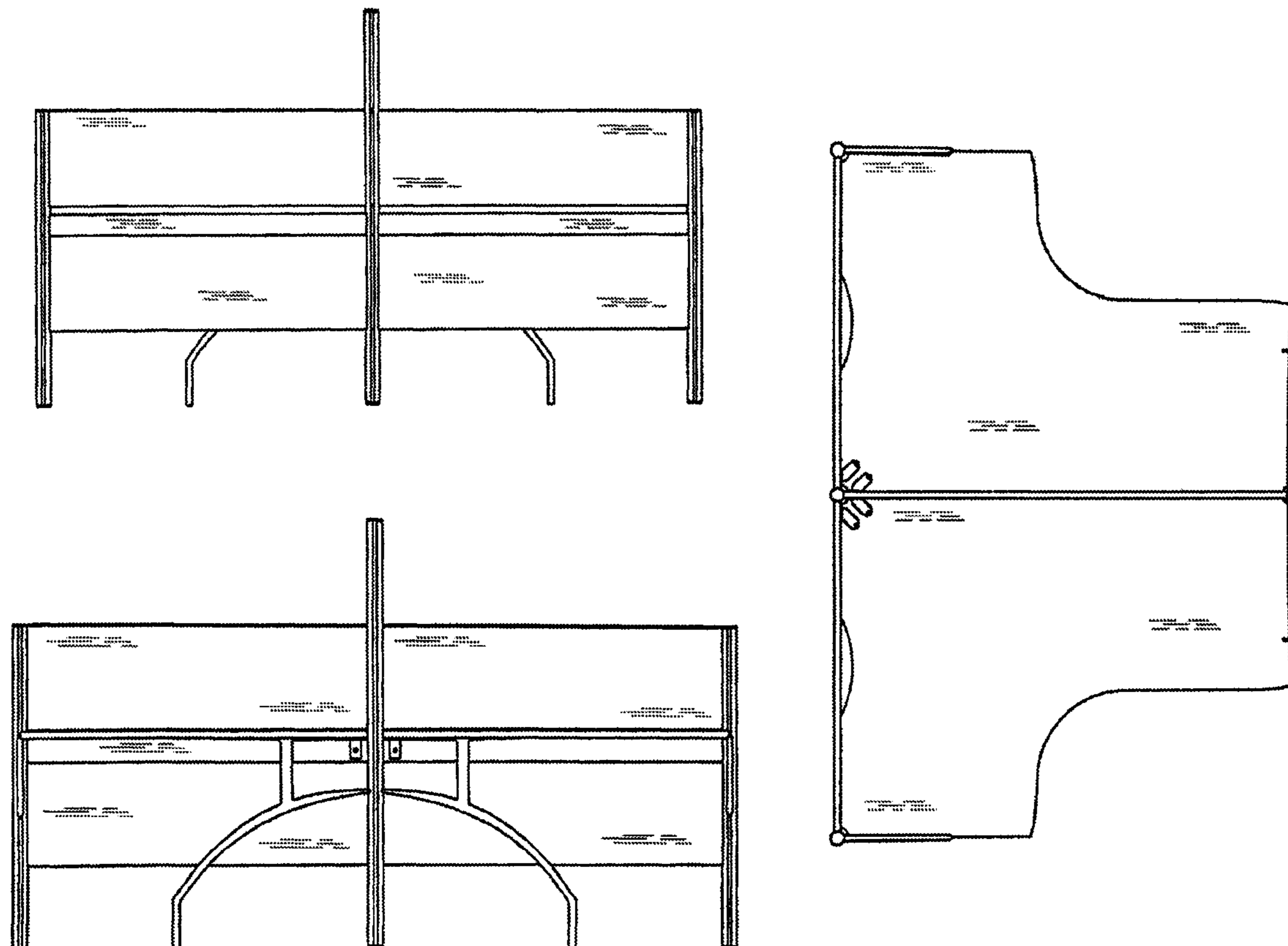

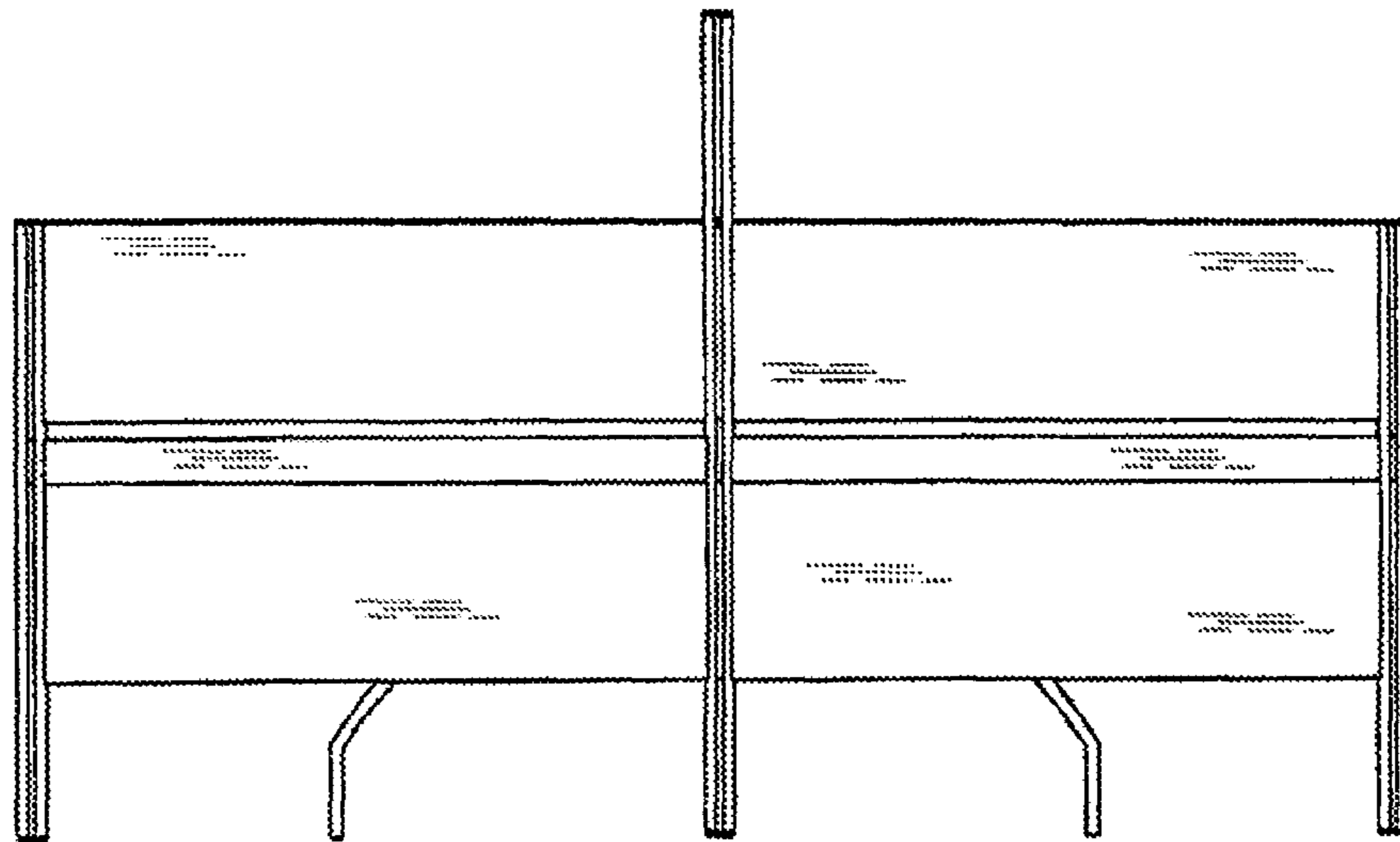

FIG. 1

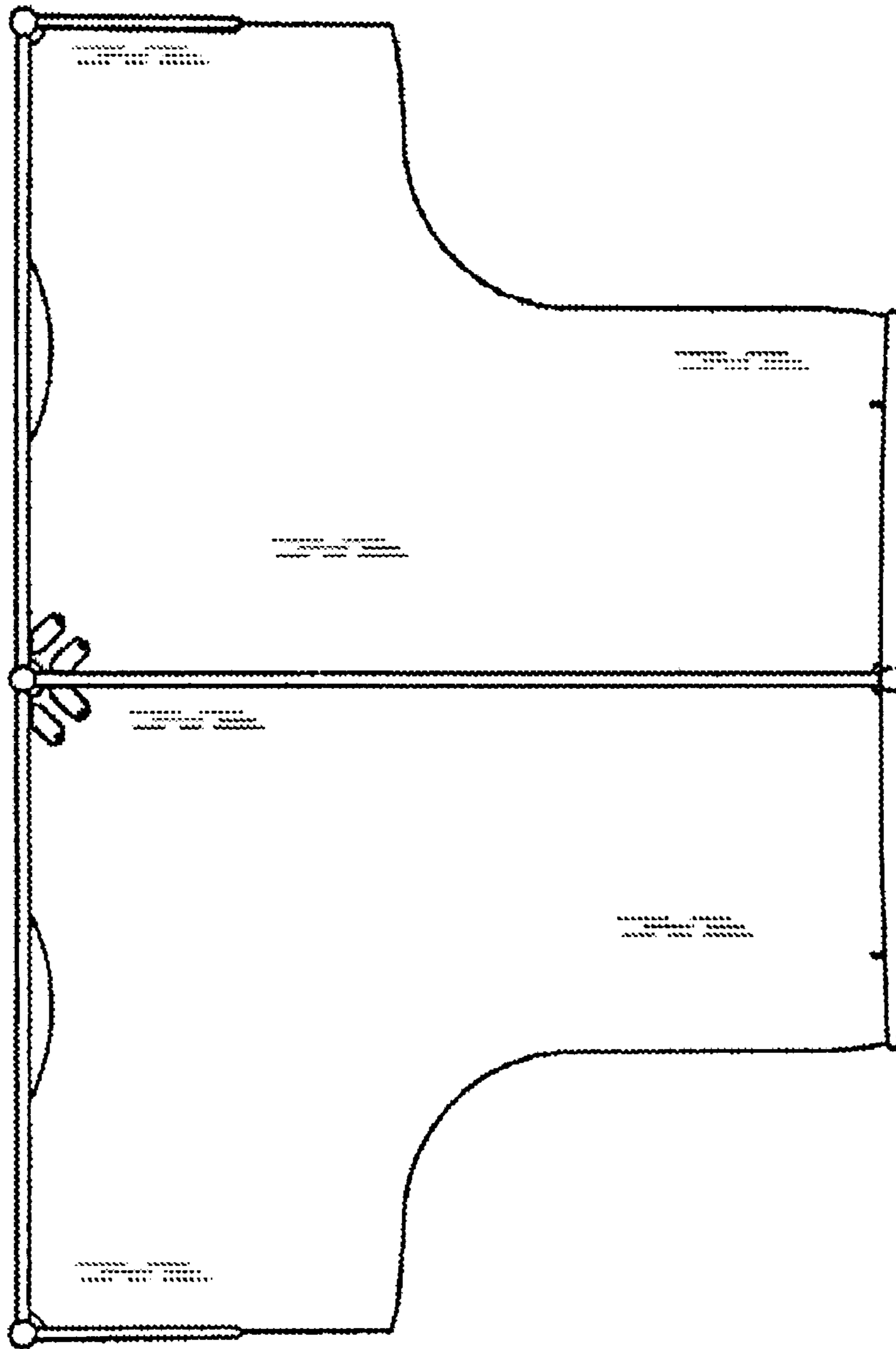

FIG. 2

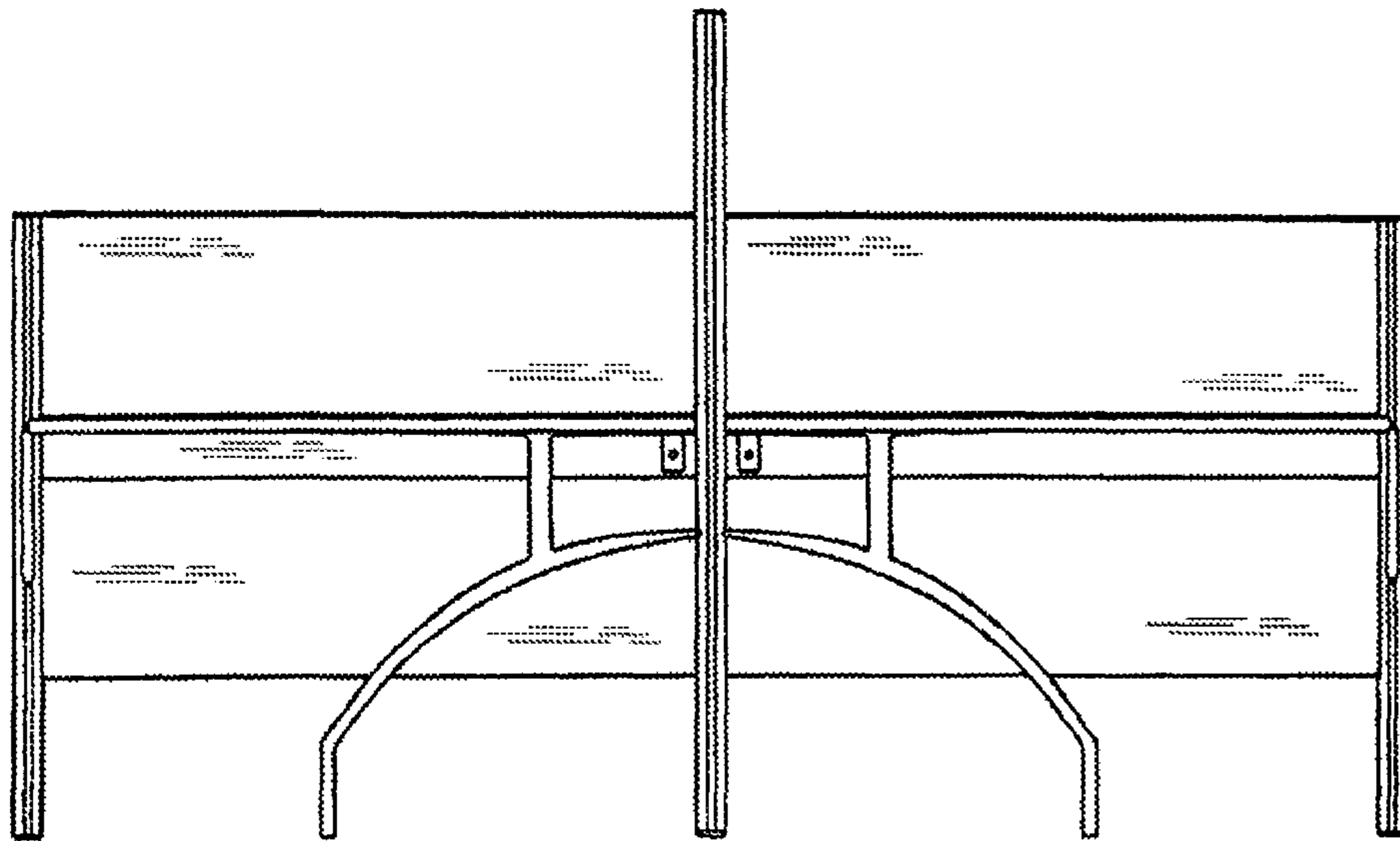

FIG. 3

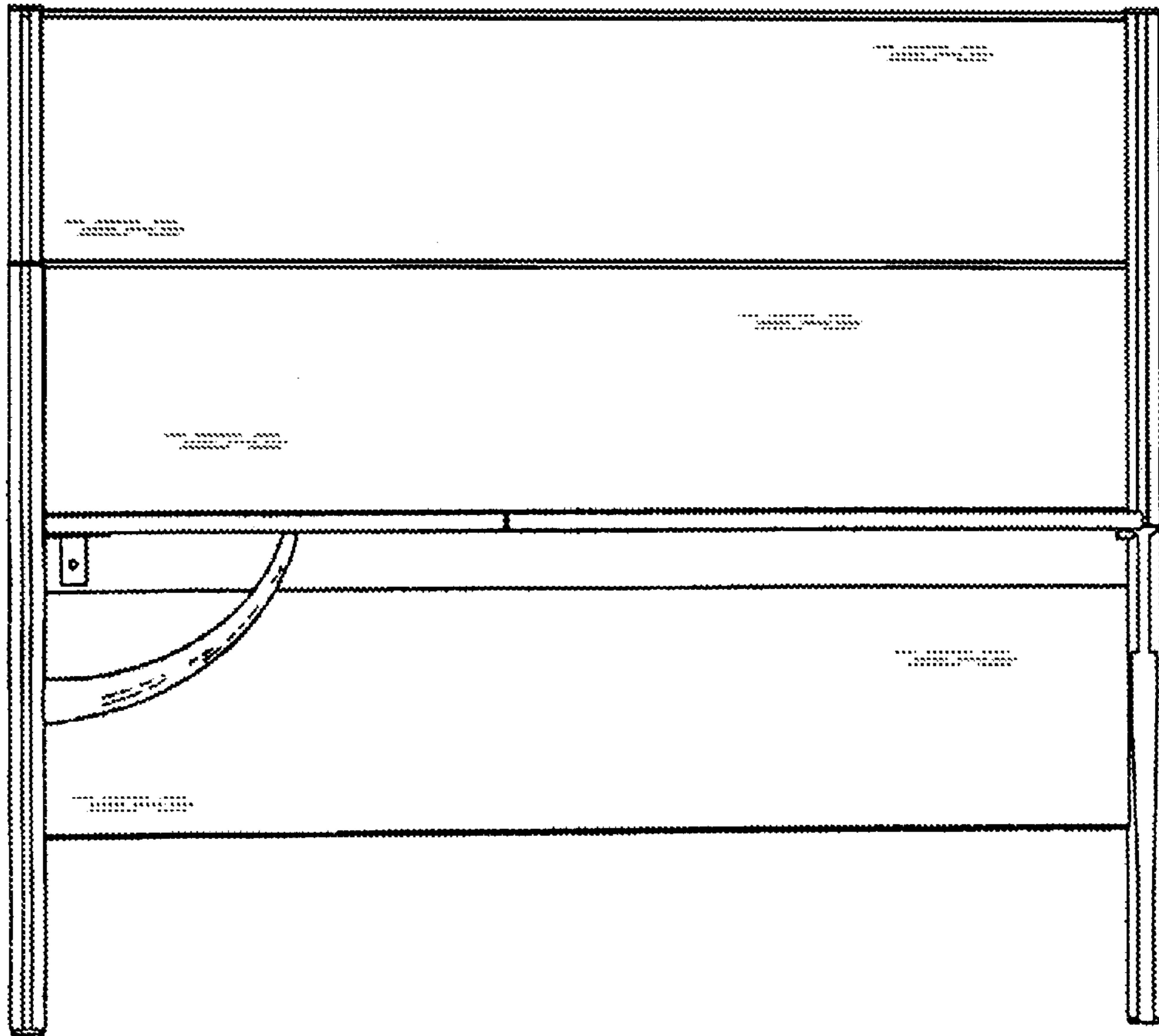

FIG. 4

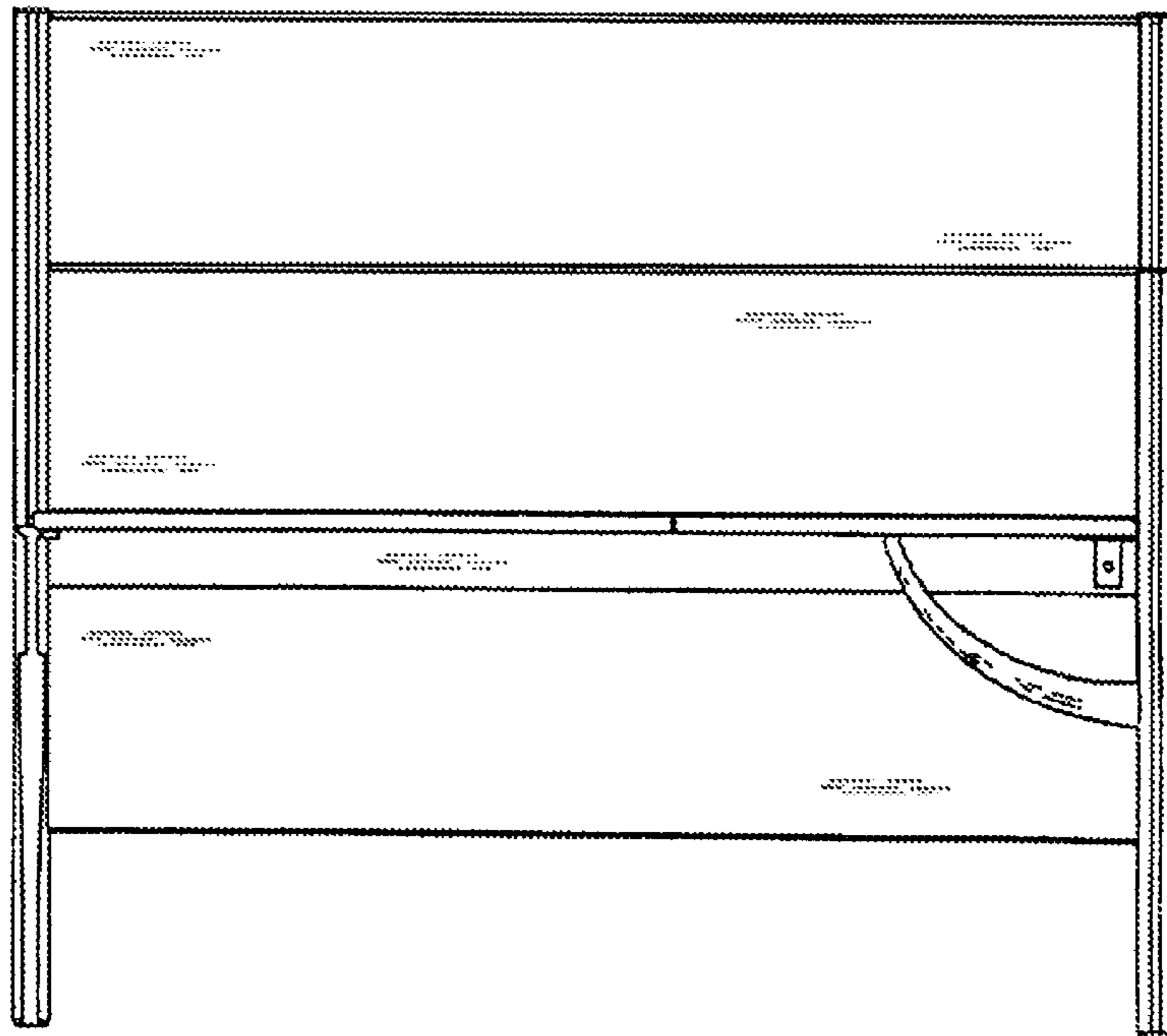

FIG. 5

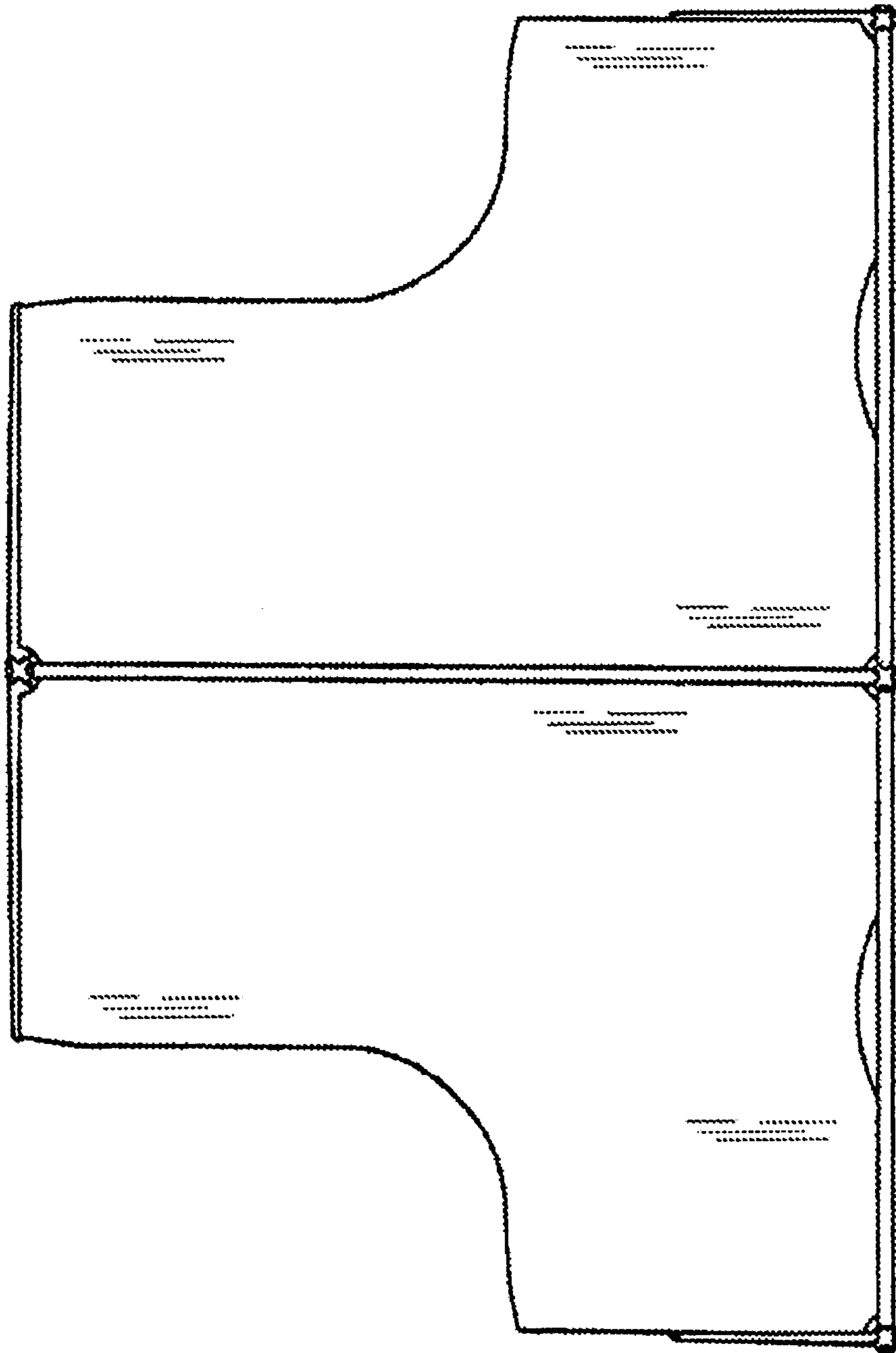

FIG. 6