

US00D525758S

(12) **United States Design Patent**
Lynch

(10) **Patent No.:** **US D525,758 S**

(45) **Date of Patent:** **** Jul. 25, 2006**

(54) **CART**

(76) **Inventor:** **Christopher G. Lynch**, 2211 Tory Way,
Forest Hill, MD (US) 21234

(**) **Term:** **14 Years**

(21) **Appl. No.:** **29/189,920**

(22) **Filed:** **Sep. 13, 2003**

(51) **LOC (8) Cl.** **12-02**

(52) **U.S. Cl.** **D34/12**

(58) **Field of Classification Search** D34/12-15,
D34/20-21, 24-27; 280/47.26, 47.34, 47.35
See application file for complete search history.

(56) **References Cited**

U.S. PATENT DOCUMENTS

D134,941 S	*	2/1943	Hansen	D34/24
3,677,571 A		7/1972	Maturo, Jr. et al.		
D252,265 S	*	7/1979	Gardner	D34/25
4,316,615 A		2/1982	Willette		
D292,135 S	*	9/1987	Grube et al.	D34/24

D334,640 S		4/1993	Forish		
5,511,682 A	*	4/1996	Pace	280/47.26
5,660,403 A		8/1997	O'Neill et al.		
D403,827 S		1/1999	Smoker		
5,915,722 A		6/1999	Thrasher et al.		
6,131,925 A		10/2000	Weldon		

* cited by examiner

Primary Examiner—Holly Baynham

(57) **CLAIM**

The ornamental design for a cart, as shown and described.

DESCRIPTION

FIG. 1 is a front elevational view of a cart showing my new design;
FIG. 2 is a rear elevational view thereof;
FIG. 3 is a side view, taken from the left side of FIG. 1;
FIG. 4 is a side view, taken from the right side of FIG. 1;
FIG. 5 is a top plan view thereof;
FIG. 6 is a bottom plan view thereof; and,
FIG. 7 is a perspective view thereof.

1 Claim, 4 Drawing Sheets

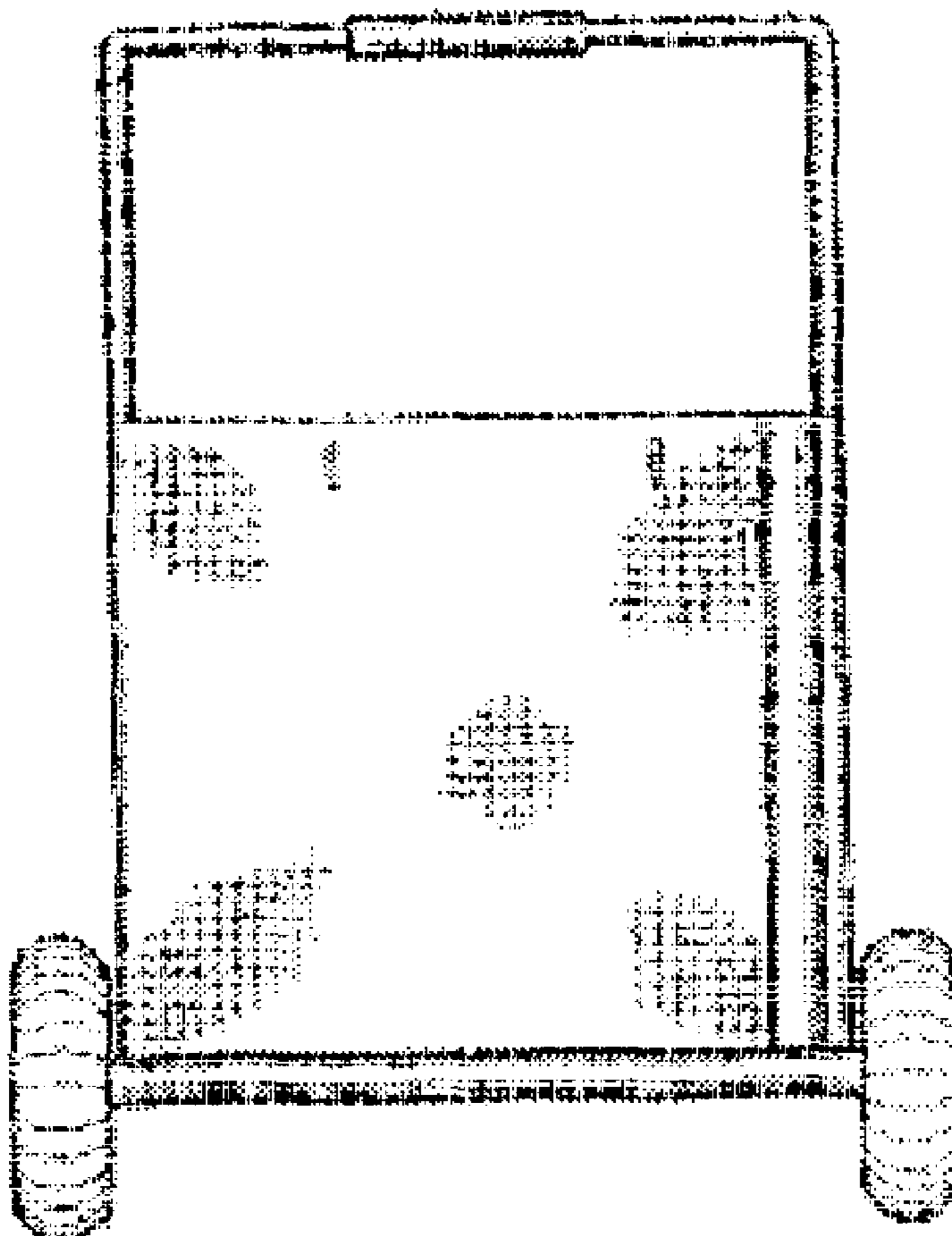

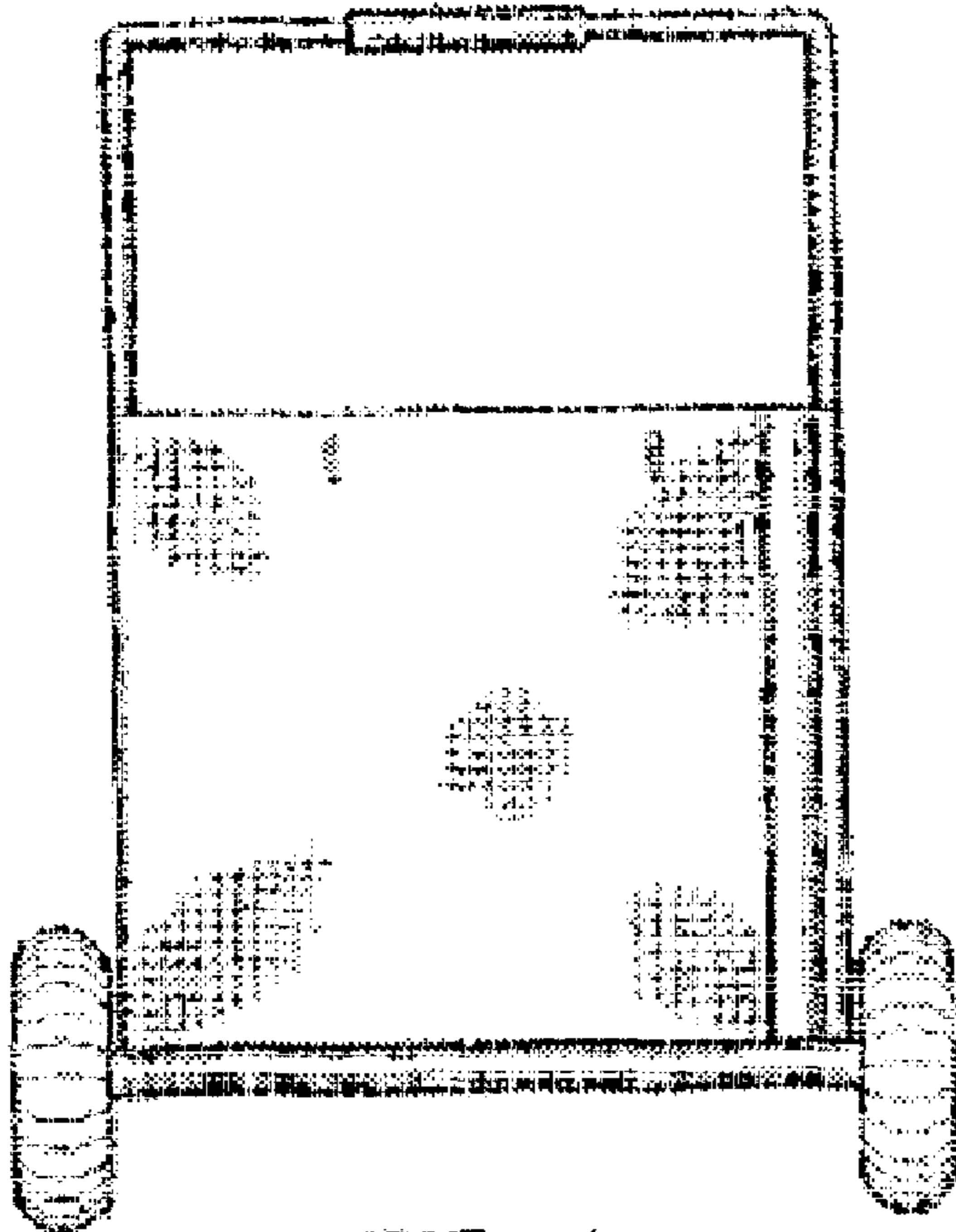

FIG. 1

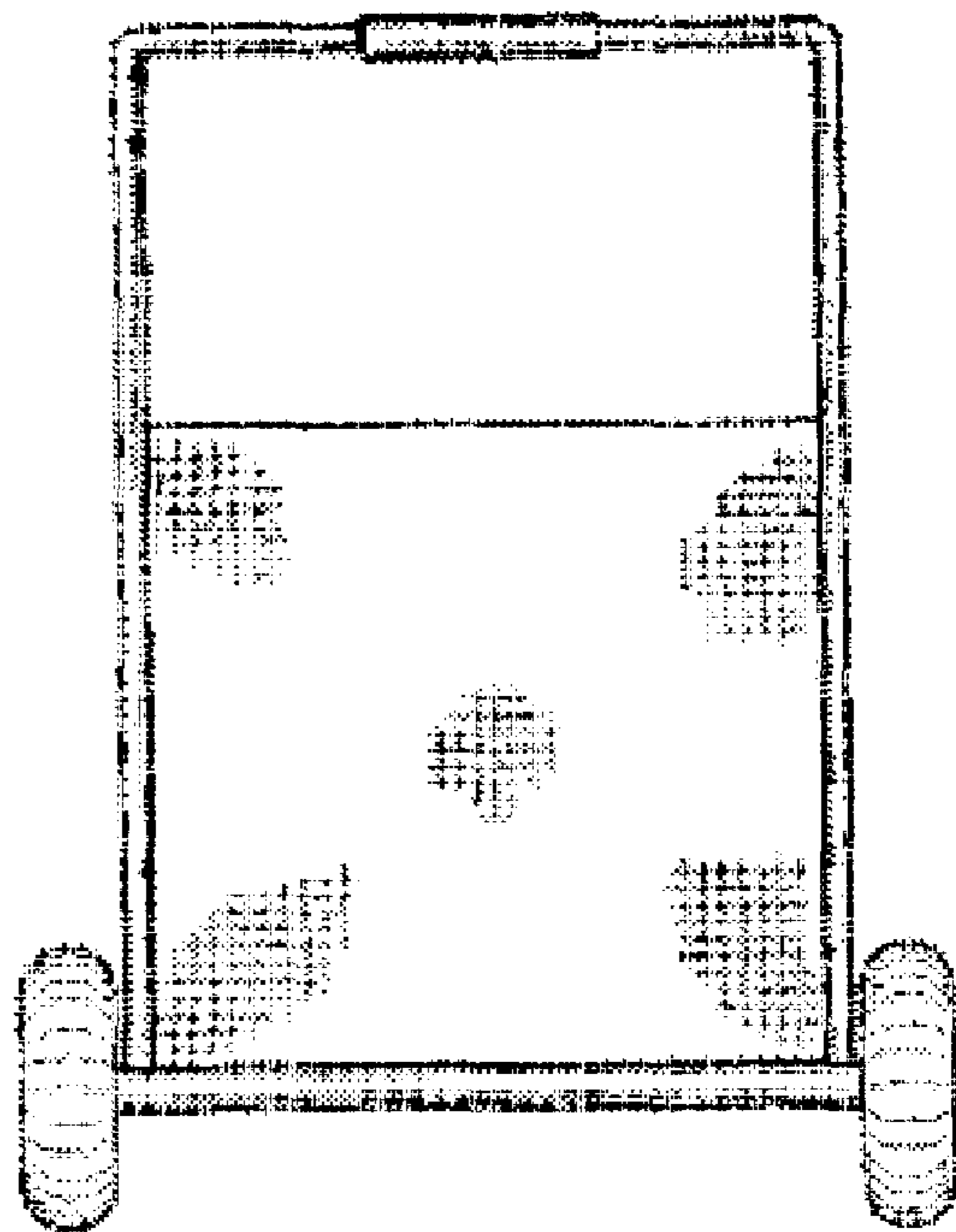

FIG. 2

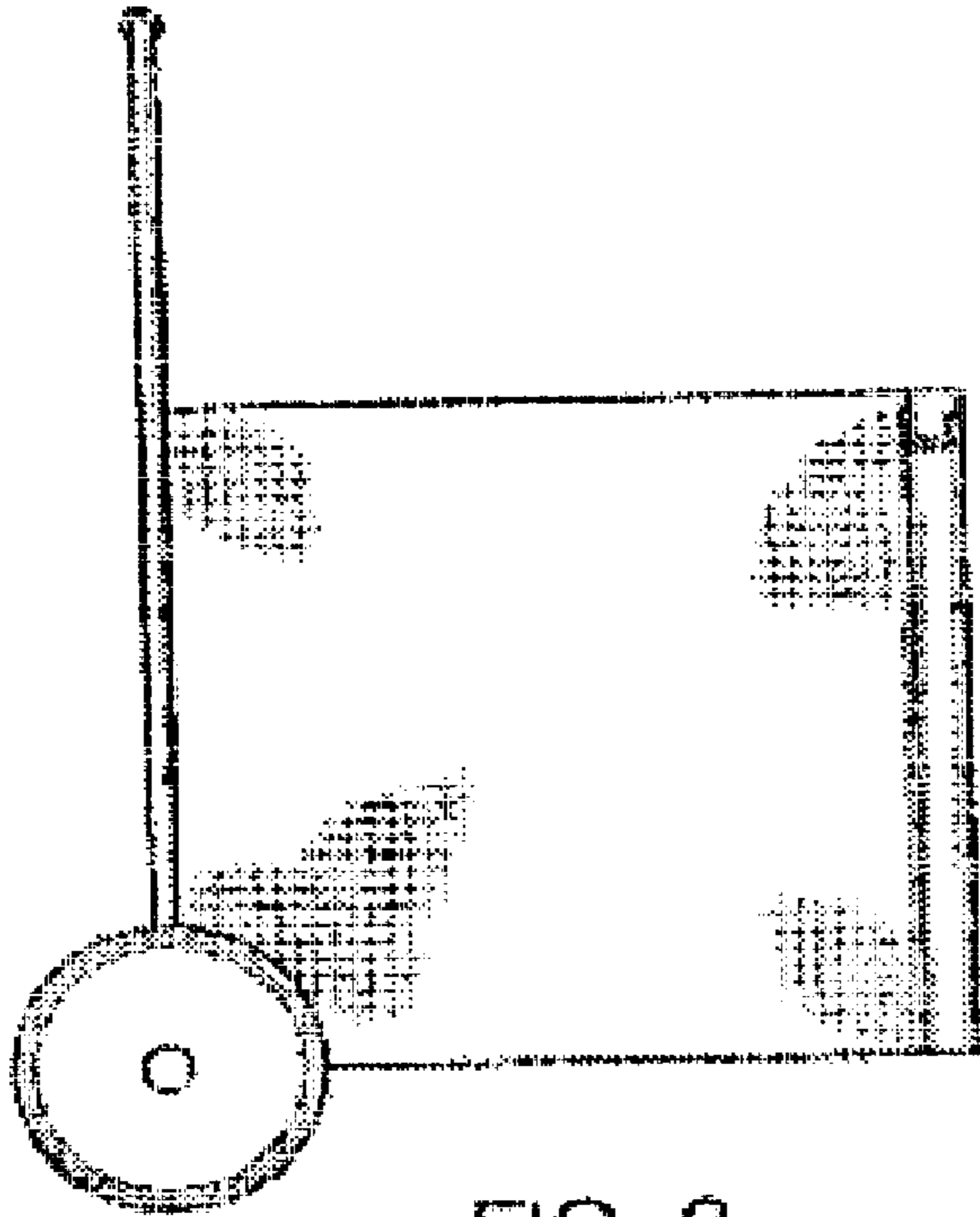

FIG. 3

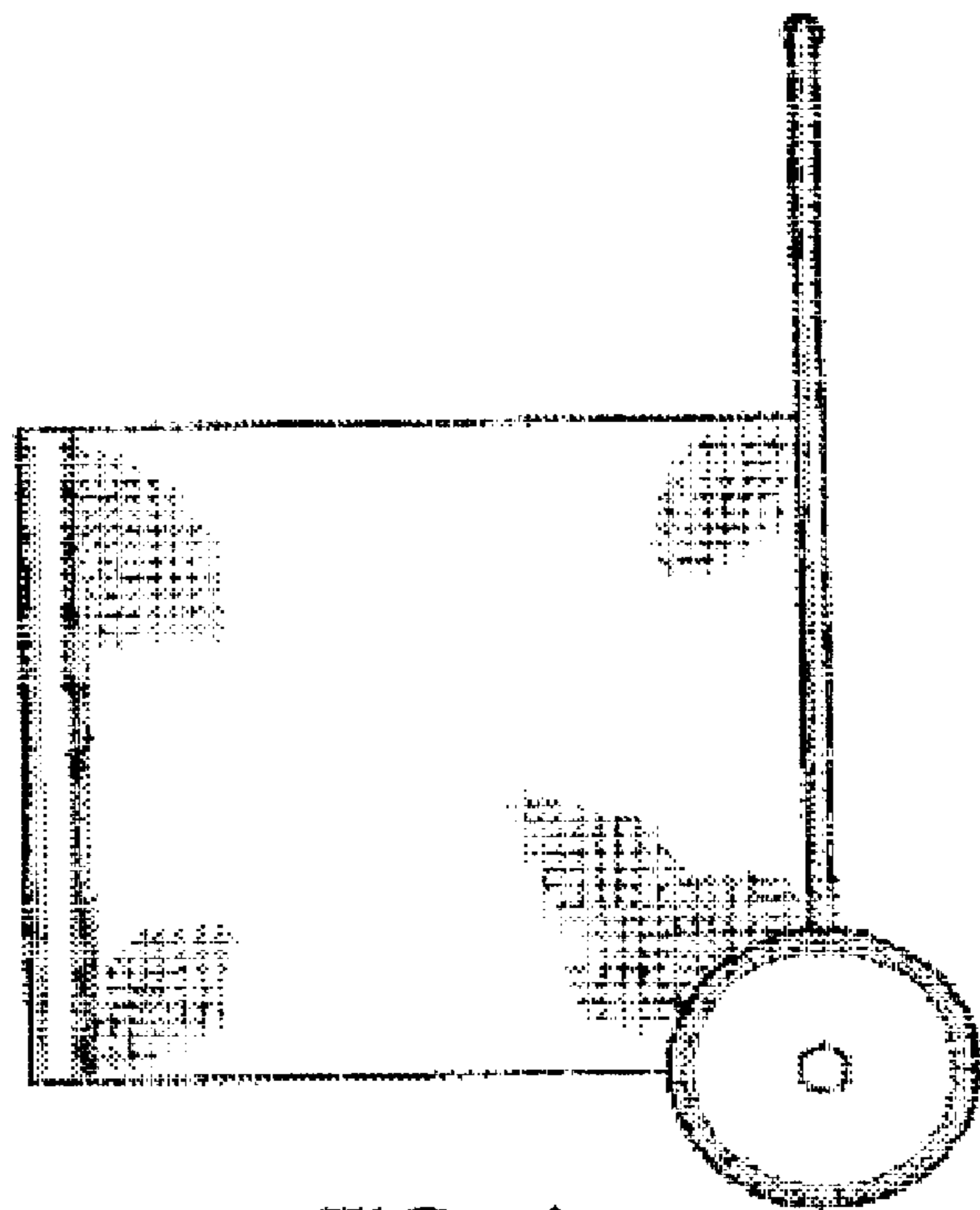

FIG. 4

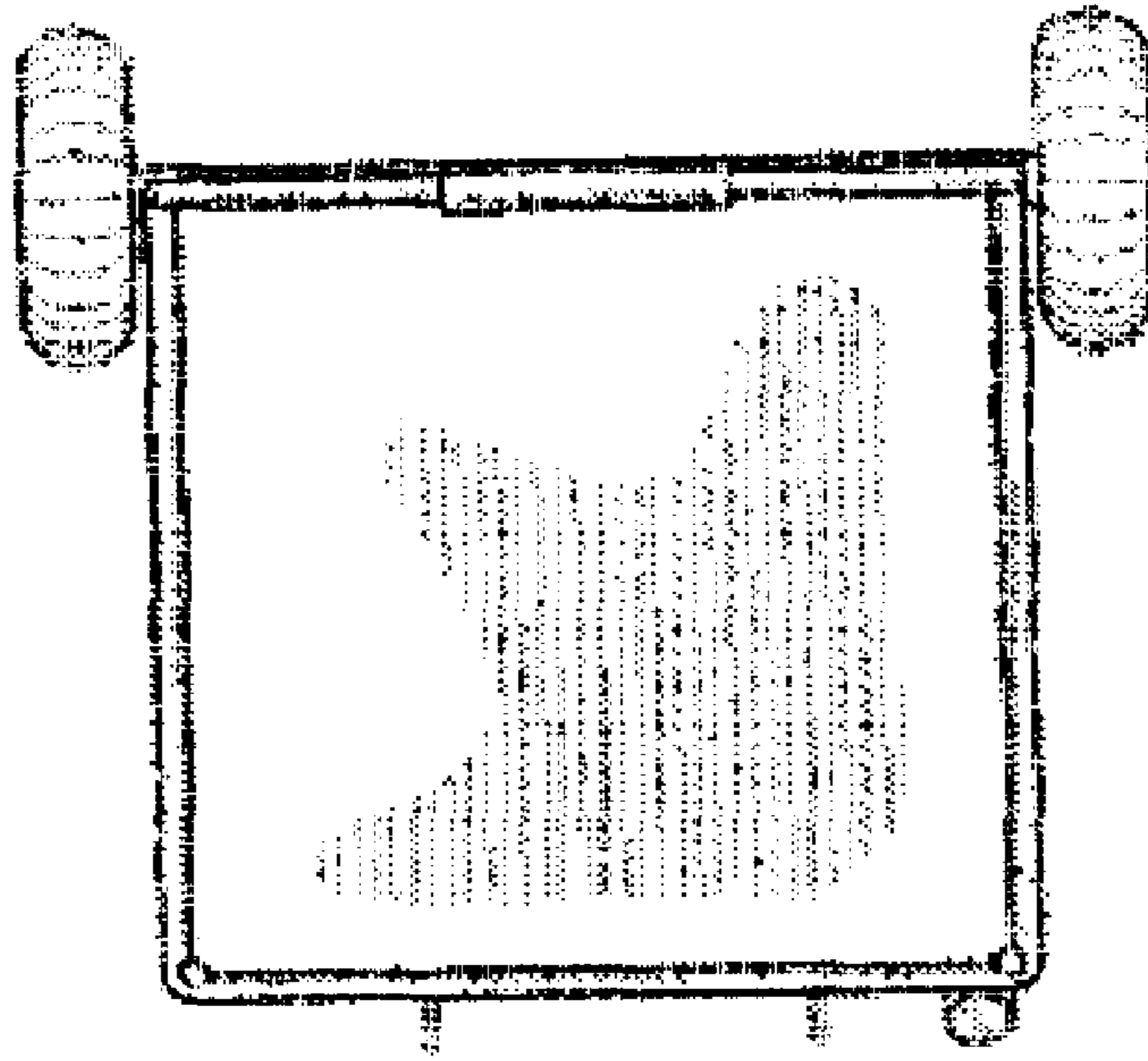

FIG. 5

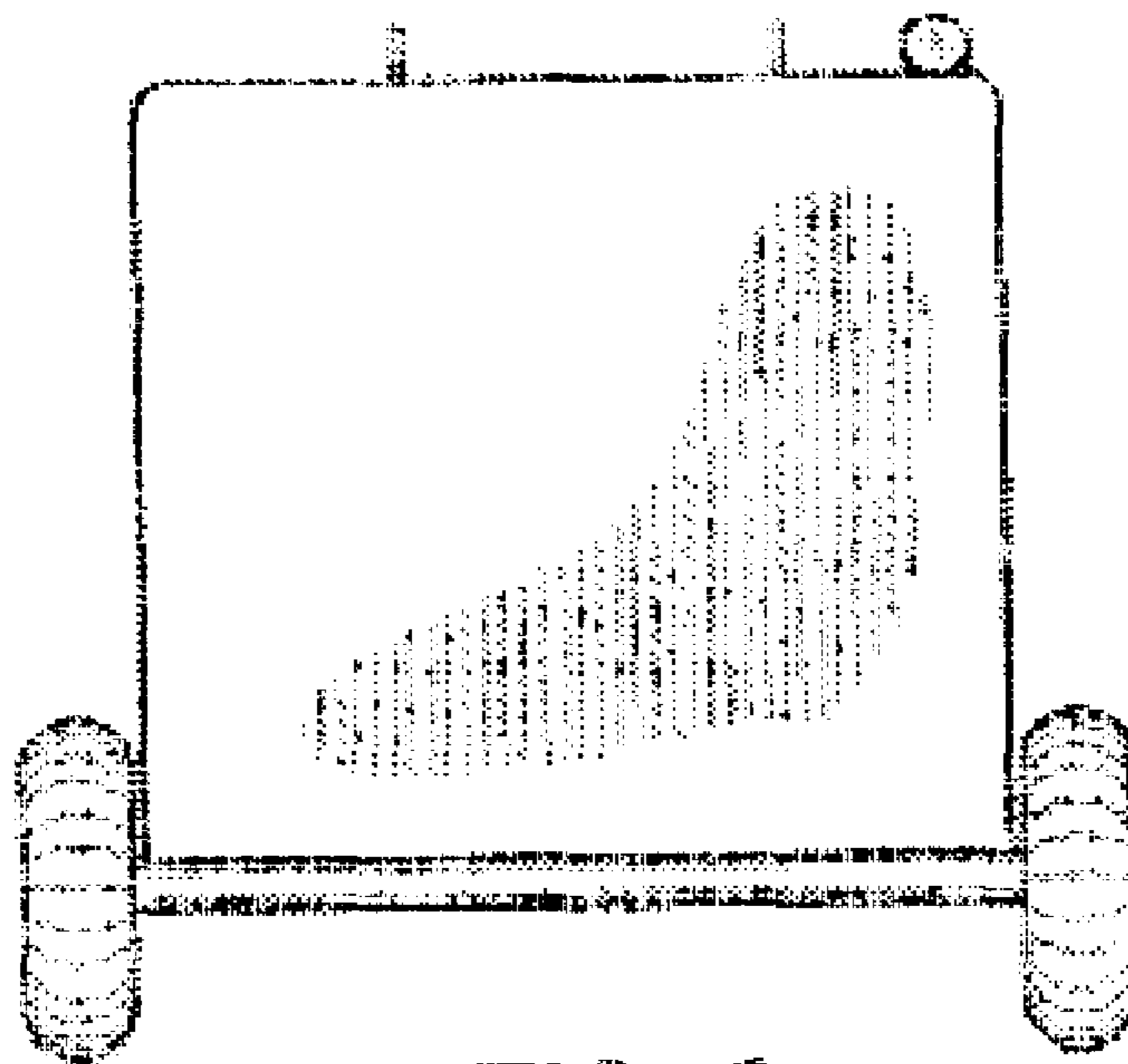

FIG. 6

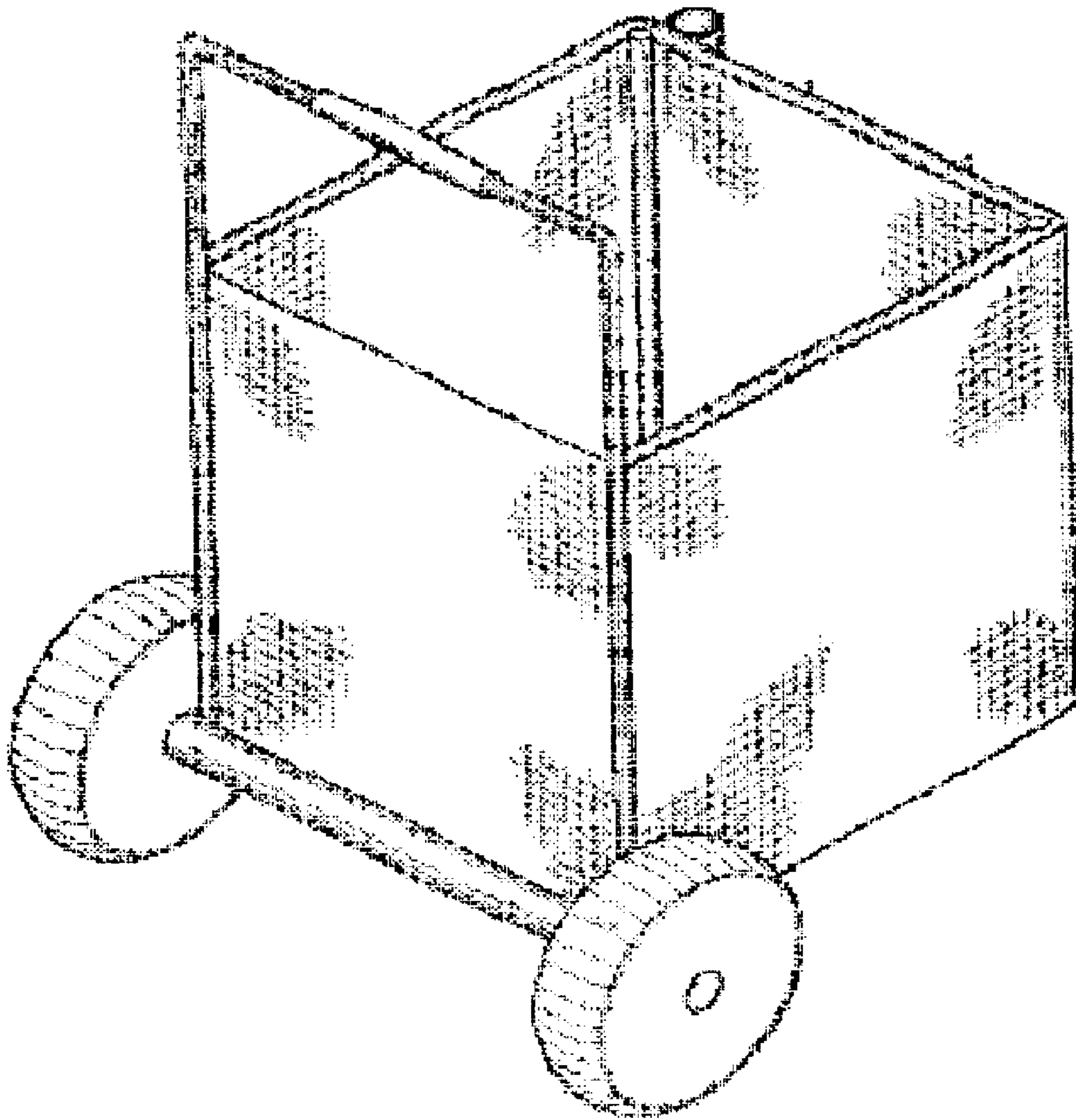

FIG. 7