

US00D525736S

(12) **United States Design Patent**
Smith et al.

(10) **Patent No.:** **US D525,736 S**

(45) **Date of Patent:** **** Jul. 25, 2006**

(54) **PORTION OF AN ILLUMINATING DEVICE**

(75) Inventors: **John Smith**, San Francisco, CA (US);
Raymond Clepper, Brooklyn, NY
(US); **David Nelson**, Las Vegas, NV
(US)

(73) Assignee: **Sol-Light, LLC**, Las Vegas, NV (US)

(**) Term: **14 Years**

(21) Appl. No.: **29/243,302**

(22) Filed: **Nov. 23, 2005**

(51) **LOC (8) Cl.** **26-05**

(52) **U.S. Cl.** **D26/60; D26/138**

(58) **Field of Classification Search** D26/28,
D26/37, 39, 44, 57, 73, 60-65, 138; 362/98,
362/99, 197, 198, 157, 171-174, 473-476,
362/523, 545, 183-208

See application file for complete search history.

(56) **References Cited**

U.S. PATENT DOCUMENTS

D270,483 S * 9/1983 Gardner et al. D26/63
D301,753 S * 6/1989 Iacovelli D26/60
D330,436 S * 10/1992 Chan D26/62

(Continued)

OTHER PUBLICATIONS

ZELCO, Long Reach Flexible Flashlight, DiversityBusiness.com, 1 page, date unknown, but prior to filing.

ZELCO, Itty Bitty Book Light Led Edition, DiversityBusiness.com, 1 page, date unknown, but prior to filing.

ZELCO, Follo™ The Lighted Clipboard Bookstand, DiversityBusiness.com, 1 page, date unknown, but prior to filing.

ZELCO, The Bugless Lantern, DiversityBusiness.com, 1 page, date unknown, but prior to filing.

ZELCO, Rubberneck Clip Lite, DiversityBusiness.com, 1 page, date unknown, but prior to filing.

ZELCO, Micro Fluorescent Lantern, DiversityBusiness.com, 1 page, date unknown, but prior to filing.

ZELCO, The Audio 'itty bitty' Booklight, (battery version), DiversityBusiness.com, 1 page, date unknown, but prior to filing.

ZELCO, The Fluorescent 'itty bitty' Book Light, DiversityBusiness.com, 1 page, date unknown, but prior to filing.

ZELCO, Lumifier, DiversityBusiness.com, 1 page, date unknown, but prior to filing.

ZELCO, Little Laptop Light, DiversityBusiness.com, 1 page, date unknown, but prior to filing.

ZELCO, The BBQ Grill Light, DiversityBusiness.com, 1 page, date unknown, but prior to filing.

"Bright As Day!" Daylight Spectrum Booklite, Product No. SI292SIL, sharperimage.com, 2 pages, date unknown, but prior to filing.

High-Brightness Dual LED Booklight, Product No. SI289BLK, sharperimage.com, 2 pages, date unknown, but prior to filing.

Opamerica, Ultralife Reading Light, opamerica.com, 4 pages, date unknown, but prior to filing.

Primary Examiner—Clare E Hefflin

(74) *Attorney, Agent, or Firm*—Banner & Witcoff, Ltd.

(57) **CLAIM**

The ornamental design for a portion of an illuminating device, as shown and described.

DESCRIPTION

FIG. 1 is a front perspective view of a portion of an illuminating device showing our new design;

FIG. 2 is a top plan view thereof;

FIG. 3 is a bottom plan view thereof;

FIG. 4 is a front view thereof;

FIG. 5 is a rear view thereof;

FIG. 6 is a left side view thereof; and,

FIG. 7 is a right side view thereof.

The unshaded interior faces of the base form no part of the claimed design. The broken line showing of the interior elements of the base, the seven circles on the exterior face of the base, and the remainder of the illuminating device is for illustrative purposes only and forms no part of the claimed design.

1 Claim, 3 Drawing Sheets

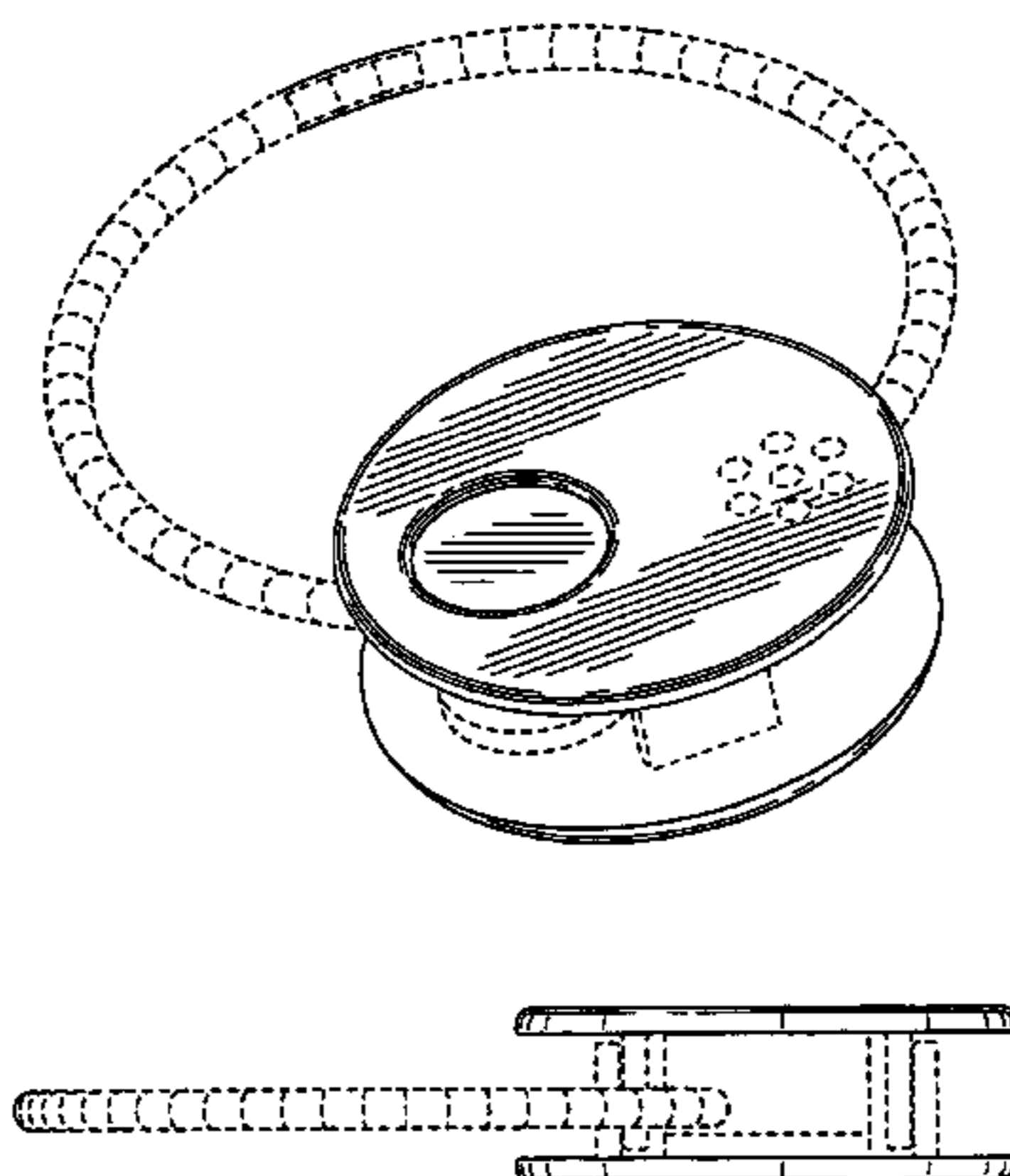

US D525,736 S

Page 2

U.S. PATENT DOCUMENTS

D407,517 S	*	3/1999	Zeller	D26/60	2002/0071271 A1	6/2002	Naghi et al.
D498,322 S	*	11/2004	Schnell	D26/60	2002/0131263 A1	9/2002	Naghi et al.
D505,739 S	*	5/2005	Hajianpour	D26/37	2003/0081407 A1	5/2003	Bennett, Jr.
2001/0026445 A1		10/2001	Naghi et al.		2003/0179572 A1	9/2003	Schnell
2002/0067609 A1		6/2002	Naghi et al.		2003/0193795 A1	10/2003	Brown
2002/0071269 A1		6/2002	Naghi et al.				

* cited by examiner

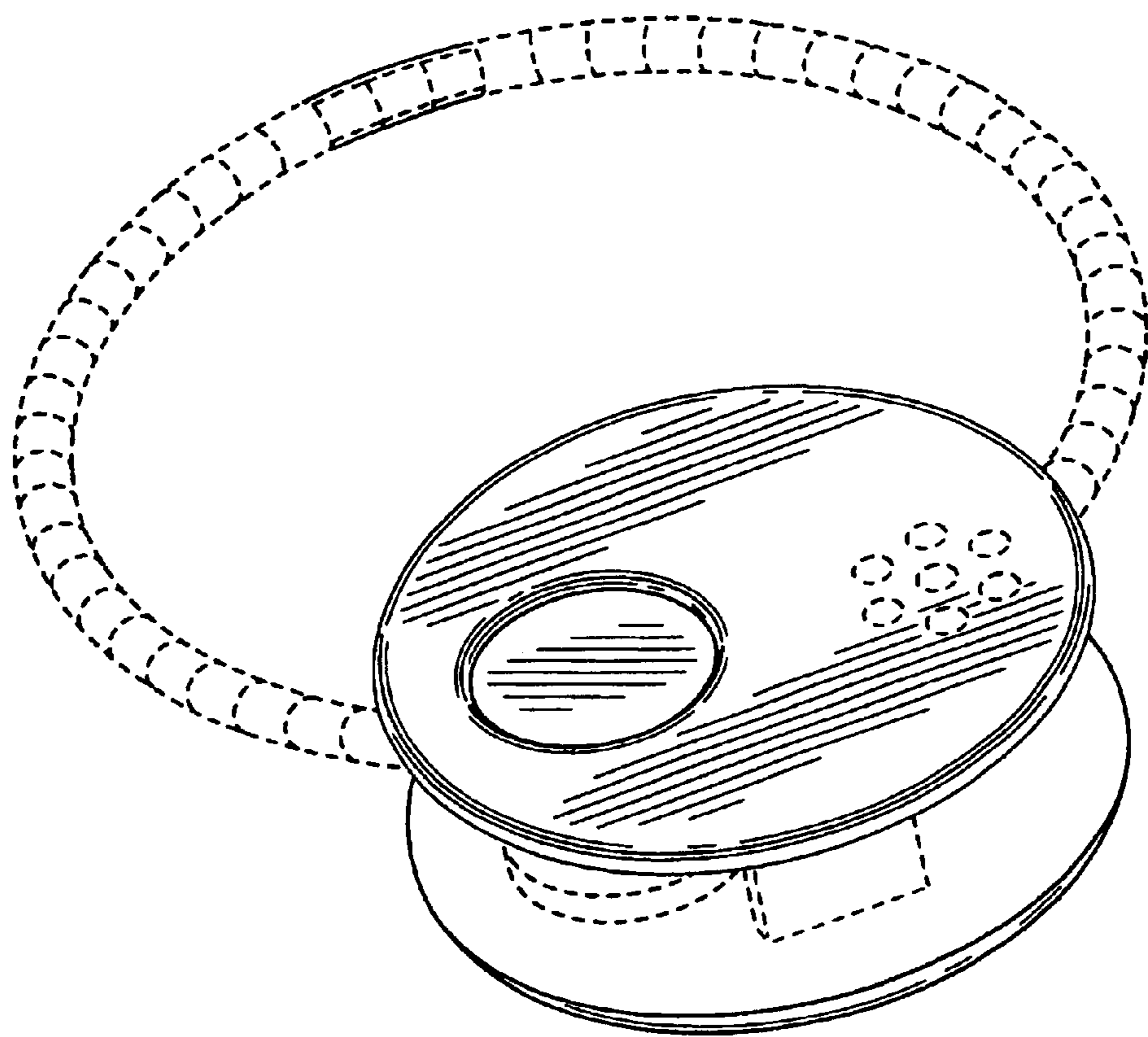

FIG. 1

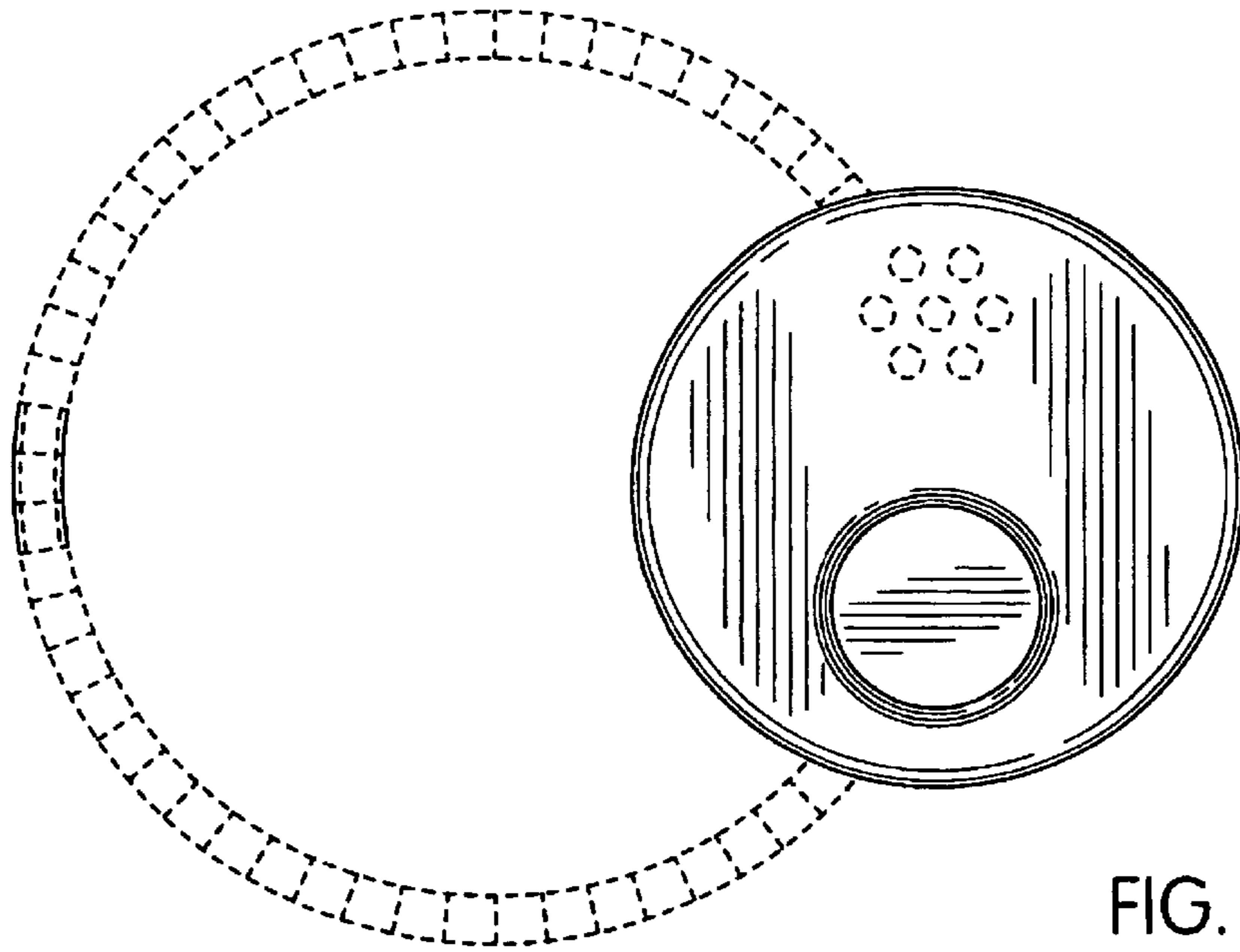

FIG. 2

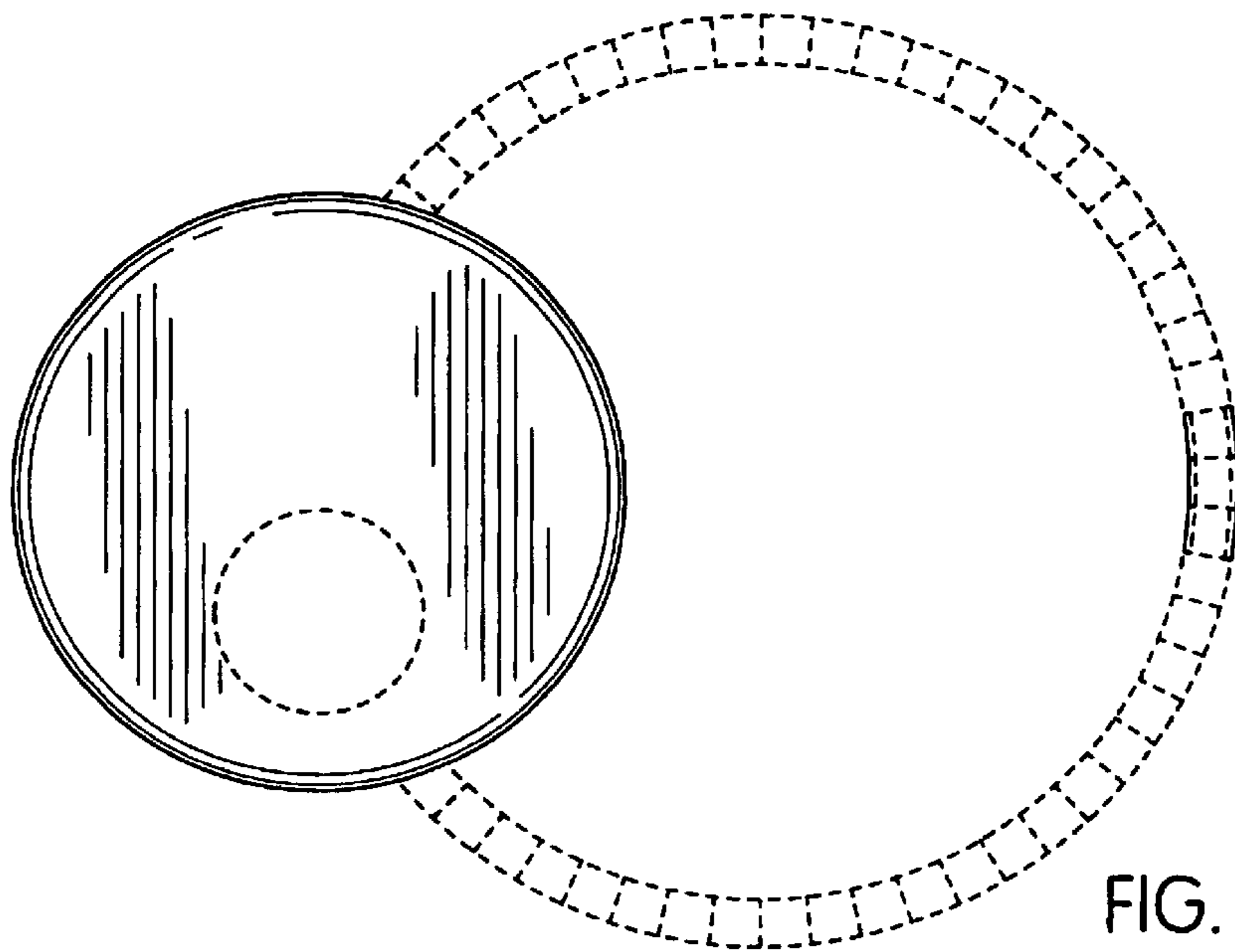

FIG. 3

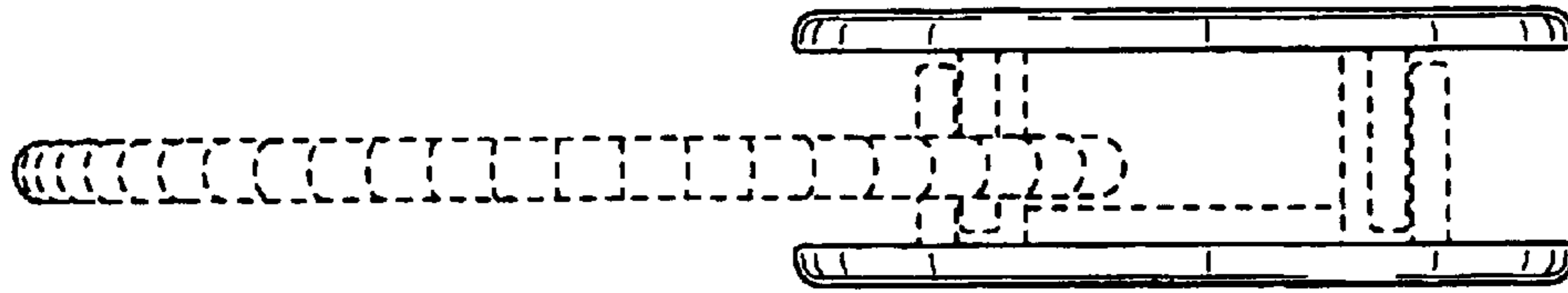

FIG. 4

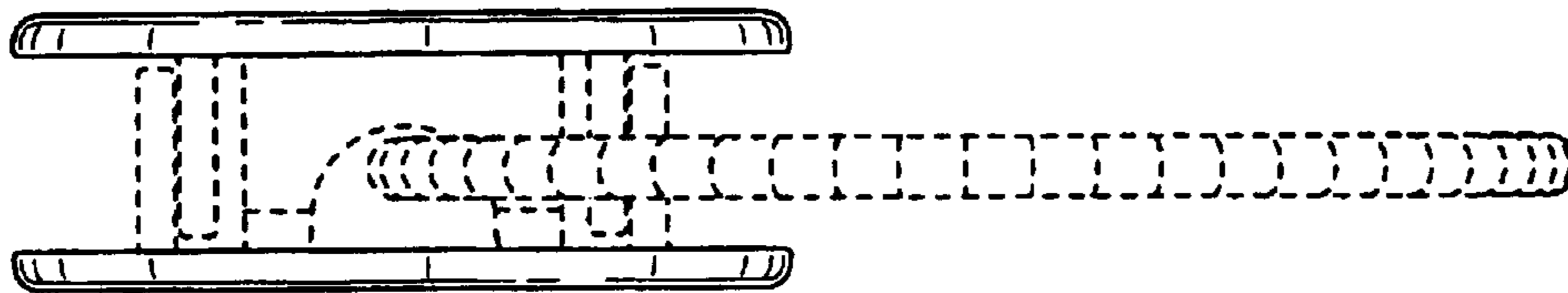

FIG. 5

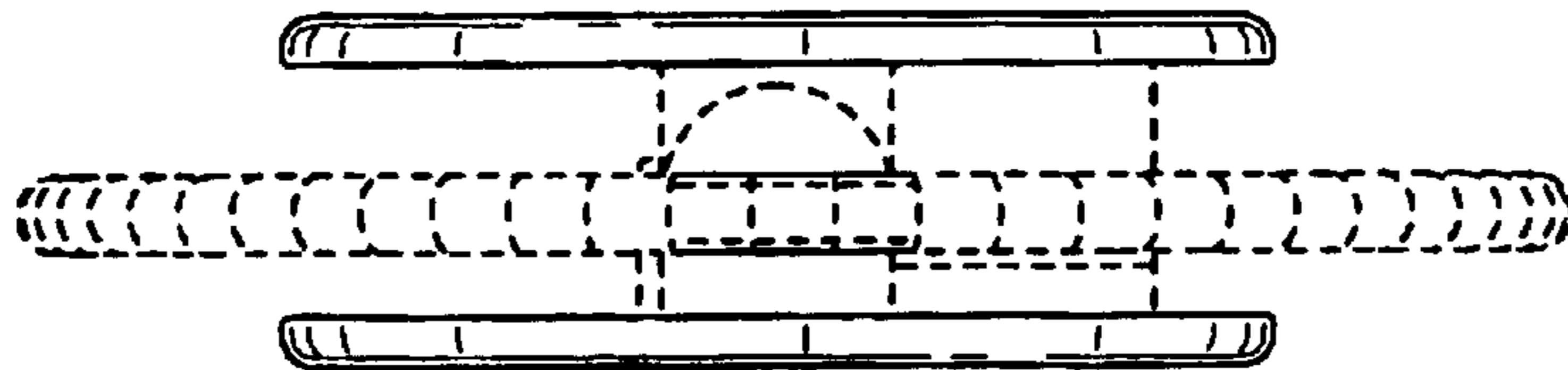

FIG. 6

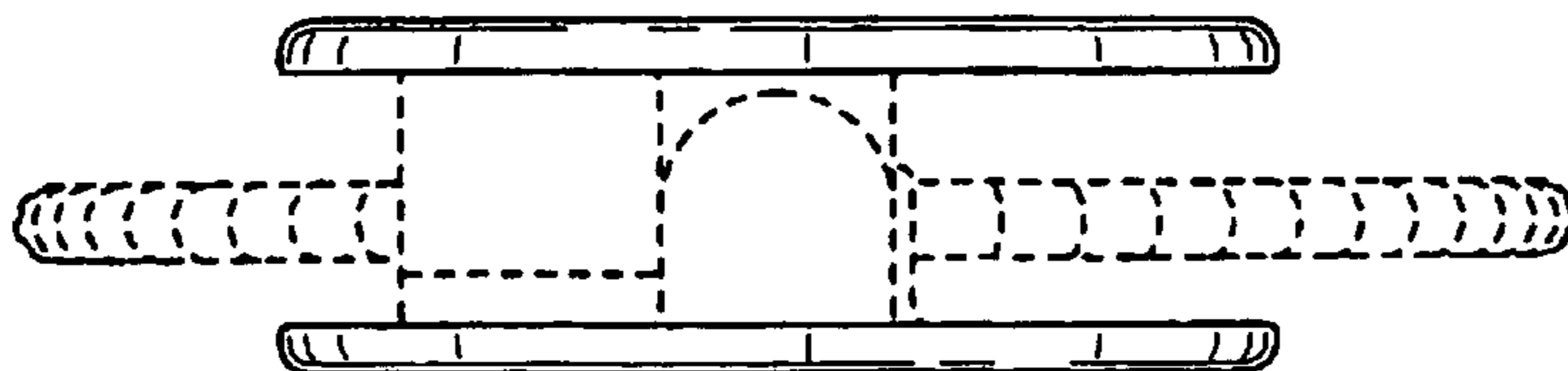

FIG. 7